



ROHDE & SCHWARZ

Test and Measurement
Division

Software Manual

GSM/DCS/PCS Base Station Tests

Application Firmware Module FSE-K11

Measurement according to Transmission Standards

1057.3392.02

Printed in the Federal
Republic of Germany

Supplement to FSE-K10 and FSE-K11 Manuals

K10/K11 Limit Lines

For FSE options K10 and K11 (GSM mobile station and GSM base station analyzer), many internal limit lines are used which are derived from the applicable standards. **To make these limit lines accessible to the user, they are available as data sets.** There are 6 data sets:

K10_XGSM.LIA	Limit lines for mobiles, standards EGSM, PGSM and RGSM
K10_DCS.LIA	Limit lines for mobiles, standards DCS1800 (GSM 1800)
K10_PCS.LIA	Limit lines for mobiles, standards PCS1900 (GSM 1900)
K11_XGSM.LIA	Limit lines for base stations, standards EGSM, PGSM und RGSM
K11_DCS.LIA	Limit lines for base stations, standards DCS1800 (GSM 1800)
K11_PCS.LIA	Limit lines for base stations, standards PCS1900 (GSM 1900)

To load the data sets, proceed as follows:

1. Copy the desired data sets (one or several) from the CD to disk or analyzer.
2. Press the hardkey RECALL, and enter path (for example A:\) via softkey EDIT PATH (see operating manual, section 2.7.3).
3. Select menu item "Lines" via softkey ITEMS TO RECALL (this is the default setting; see operating manual, section 2.7.3.1).
4. Select the desired data set via softkey DATA SET LIST. This will cause all limit lines of the selected data sets to be copied to the limit line directory of the instrument.

From the GSM software, the limit lines can be accessed and edited via the softkey EDIT in the righthand side menus of the following measurements:

- Power vs time
- Modulation spectrum
- Transient spectrum or
- Spurious

Outside GSM measurements, the limit lines are accessible in the analyzer mode of the instrument.

Contents

Index

	<i>Page</i>
1 Getting Started.....	1.1
1.1 Connecting the FSE/FSIQ	1.2
1.1.1 Standard Test Setup.....	1.2
1.1.2 Test Setup for Measurements in the RX Band (Spurious ① and Modulation Spectrum).....	1.4
1.1.3 Test Setup for Measuring Spurious in the TX and outside the TX/RX Band (<>TX Band):	1.4
1.2 Presetting the FSE/FSIQ	1.6
1.3 Measuring the Phase/Frequency Error ①	1.22
1.4 Measuring the Average Carrier Power ①	1.26
1.5 Measuring the Carrier Power versus Time ① ②	1.32
1.6 Measuring the Spectrum due to Modulation ①	1.38
1.7 Measurement of Spectrum due to Transients ①	1.42
1.8 Measurement of Spurious ①	1.44
2 General Information on Option FSE-K11.....	2-1
2.1 Sequence of Operations of FSE-K11 Measurements.....	2-2
2.1.1 Errors and Failures During Measurements.....	2-18
2.1.2 Abort of Measurements	2-18
a) Abort by User.....	2-18
b) Abort by Instrument	2-19
2.1.3 Results of Measurements.....	2-19
2.2 Exiting FSE-K11	2-21
2.3 Preset	2-23
2.3.1 Analyzer Mode	2-23
2.3.2 Vector Mode.....	2-23
2.4 General Remarks	2-24
2.5 Standard	2-25

3	Measurements with Option FSE-K11	3.1
3.1	Starting the Application	3.1
3.2	Menu Overview	3.2
3.3	Selection of Default Settings.....	3.9
3.3.1	Selection of the Standard.....	3.9
3.3.2	Consideration of the External Attenuation	3.10
3.3.3	Setting the Transmission Channel.....	3.11
3.3.4	Setting the Transmit Power of the BTS under Test	3.14
3.3.5	Setting the Limit Margin (limit tolerance range)	3.20
3.3.6	Selection of the Midamble	3.21
3.3.7	Selection of the Timeslot	3.22
3.3.8	Setting of the Trigger	3.22
3.3.9	Default Settings.....	3.27
3.3.10	Selection and Edition of Limit Lines	3.29
3.3.11	Limit Values and Limit Lines	3.32
3.3.11.1	Types of Limit Values.....	3.32
3.3.11.2	Calculation of Relative Limit Lines	3.33
3.3.11.3	Special Features with Relative Limit Lines	3.33
3.3.11.4	Forms of Output.....	3.34
3.3.11.5	Table Contents of the Different Measurements.....	3.35
a)	General Structure	3.35
b)	Table Head	3.35
c)	Table Contents CPW.....	3.36
d)	Table Contents CPI	3.36
e)	Table Contents TRA	3.36
f)	Table Contents MOD.....	3.37
g)	Table Contents SPU	3.39
3.4	Measurement of Phase and Frequency Error	3.40
3.5	Measurement of Carrier Power	3.44
3.6	Measurement of Carrier Power Versus Time (Burst Timing)	3.50
3.7	Measurement of Spectrum due to Modulation	3.57
3.7.1	Result Table.....	3.60
3.7.2	Test Setup	3.60
3.7.3	Additional Information	3.61
3.7.3.1	RX Band Measurements.....	3.62
3.7.3.2	Pre-Measurement	3.63

	<i>Page</i>
3.7.3.3 Main Measurement	3.63
a) ARFCN ± 1.8 MHz Measurement – Range Close to Carrier	3.63
b) TX Band Measurement – TX Band Excluding Range Close to Carrier	3.64
c) TX Band Measurement – Complete TX Band	3.66
3.7.3.4 Limit Lines – Selection, Base Lines, Values	3.66
3.7.3.5 Exceptions	3.66
3.8 Measurement of Spectrum due to Transients	3.67
3.8.1 Additional Information	3.70
3.9 Measurement of Spurious Emissions	3.72
3.9.1 Additional Information	3.77
4 Remote Control.....	4.1
4.1 Description of Commands.....	4.1
4.1.1 CALCulate Subsystem.....	4.1
4.1.1.1 CALCulate:LIMit Subsystem	4.1
4.1.2 CONFigure Subsystem	4.5
4.1.2.1 CONFigure:BTS Subsystem	4.5
4.1.2.2 CONFigure:BURSt Subsystem	4.12
4.1.2.3 CONFigure:MS Subsystem.....	4.15
4.1.2.4 CONFigure:SPECTrum Subsystem.....	4.20
4.1.2.5 CONFigure:SPURious Subsystem	4.22
4.1.3 FETCh Subsystem.....	4.24
4.1.3.1 FETCh:BURSt Subsystem.....	4.24
4.1.3.2 FETCh:SPECTrum Subsystem.....	4.28
4.1.3.3 FETCh:SPURious Subsystem	4.31
4.1.3.4 FETCh:PTEMplate Subsystem	4.33
4.1.4 INSTRument Subsystem.....	4.34
4.1.5 READ Subsystem	4.35
4.1.5.1 READ:BURSt Subsystem	4.35
4.1.5.2 READ:SPECTrum Subsystem	4.43
4.1.5.3 READ:SPURious Subsystem.....	4.45
4.1.6 SENSE Subsystem	4.47
4.1.6.1 SENSE:BANDwidth Subsystem	4.47
4.1.6.2 SENSE:CORRection-Subsystem	4.48
4.1.7 TRIGger Subsystem	4.49
4.2 Table of Softkeys with IEC/IEEE-Bus Command Assignment	4.51
4.2.1 GSM BTS Analysis Mode (Option FSE-K11).....	4.51
4.2.1.1 CONFIGURATION Key Group	4.51
4.2.2 GSM MS Analysis Mode (Option FSE-K10)	4.59
4.2.2.1 CONFIGURATION Key Group	4.59

Index

Note: All softkeys are listed alphabetically under keyword "Softkey" with their names.

A

ARFCN (Absolute Radio Frequency Channel Number)	3.12
Attenuation (external)	3.10
Attenuation factor	3.10
Average carrier power	3.44

B

Burst	
Display modes	3.51
Number	3.46
Burst timing	3.50

C

Carrier power	3.44
Carrier power versus time	3.50
Coarse adjustment of the trigger	3.24, 3.26
Connect bandpass or bandstop to suppress TX-band!	3.58

E

Edge	
TDMA burst	3.51
Edge of a burst	3.51
Error message	
Connect bandpass or bandstop to suppress TX-band!	3.58
External trigger signal	3.22

F

Fine adjustment of the trigger	3.25
Frequency error	3.40

H

Hopping mode	3.75
--------------	------

N

Number of sweeps	1.44, 3.72
------------------	------------

O

Output of measured values in tabular form	3.66
Output power of BTS	3.44
Overview measurement in frequency domain	3.66

P

Peak power	3.16
Phase	3.9
Phase error	3.40
Power class	3.16
Power Control Level (static)	3.18
Power(average)	3.44
Powers of power control levels	3.44

R

RMS phase error	3.40
RX band	3.74

S

SET TO STANDARD	1.26, 1.32, 1.38, 1.42
Slot number	3.22
Slow frequency hopping mode	3.75
Soft key	
ANALOG DEMODB7	4.34
ANALYZER	4.34
DIGITAL DEMODB7	4.34
EMI TEST RECEIVERESIFSET	4.34
RES BW MANUAL	4.47
TRACKING GENERATOR	4.34
TV DEMOD	4.34
VECTOR ANALYZER	4.34
Softkey	
±1.8 MHz /TX BAND	3.57
<> TX BAND	3.73
ARFCN	3.13
ARFCN ±1.8 MHz	3.57
ARFCN / FREQUENCY	3.12, 3.52
ARFCN AUTOSELECT	3.13
BTS SFH ON/OFF	3.75
BURST HIGH RESOLUTION	3.51
CARRIER POWER	3.44
CLEAR SGL RESULT TAB	3.47
CONDITIONS NORM/EXTR	3.46
CONT SGL STEP LIST	3.71
CONTINUOUS	3.41, 3.50, 3.56
CONTINUOUS FREQ SWEEP	3.67
COSITING GSM/DCS	3.75
DCS 1800	3.9
DEFAULT SETTINGS	3.27
DYNAM PWR CTRL LEVEL	3.19, 3.47

EDIT	3.29
E-GSM 900	3.9
EXTERN	3.24
EXTERNAL ATTEN	3.10
FALLING EDGE	3.51
FRAME COARSE	3.24
FRAME FINE	3.25
FREE RUN	3.24
FREQUENCY	3.13
FREQUENCY	3.30
FULL BURST	3.51
GSM BTS ANALYZER	3.1
INC DYNAM PWR CTRL	3.46
INC STATIC PWR CTRL	3.45
LIMIT /PWR COUPLED	3.19
LIMIT REF POWER	3.20
MEAS BANDWIDTH	3.52, 3.68
MEAS MAX OUTPUT PWR	3.45
MEAS SGL PWR LEVEL	3.47
MIDAMBLE	3.21
MODULATION SPECTRUM	3.56
NO. OF BURSTS	3.51, 3.57, 3.67
NO. OF BURSTS	3.41, 3.46
NOMINAL OUTPUT PWR	3.16
PCS 1900	3.9
P-GSM 900	3.9
PHASE I/II/III+	3.9
PHASE PEAK	3.30
PHASE RMS	3.30
PHASE/FREQ ERROR	3.40
POWER CLASS	3.16
POWER SETTING	3.15
POWER VS TIME	3.50
REF MEAS AUTO/USER	3.52
R-GSM 900	3.9
RISING EDGE	3.51
RX BAND	3.58, 3.74
RX BAND GAIN	3.75
SETTINGS	3.9
SGL MEAS ON/OFF	3.46
SIGNAL POWER	3.20, 3.47
SINGLE	3.41
SINGLE	3.50
SINGLE FREQ SWEEP	3.56, 3.66
SLOPE POS/NEG	3.24
SLOT ADJUST	3.26
SLOT NO	3.22
SPURIOUS	3.71
START LIST	3.57, 3.68, 3.72
START LIST SGL STEP	3.71
START REF MEAS	3.52
STATIC PWR CTRL LEVEL	3.18
STATIC PWR CTRL LEVEL	3.47
SWEEP COUNT	1.44, 3.72
SWEPTIME	1.46
SWEPTIME STD/AUTO	3.75
SWP COUNT RX BAND	3.72
SWP COUNT TX /<>TX	3.72
SYNC TO MIDAMBLE	3.48, 3.53
TRANSIENT SPECTRUM	3.66
TRIGGER	3.23
TRIGGER ADJUST	3.24
TRIGGER LEVEL	3.26
TX BAND	3.57, 3.72
TX BAND ± 2 MHz	3.75
TX GATE ON/OFF	3.58
TX SUPPR ON/OFF	3.75
X UNIT SYMB/TIME	3.52

Softkeys	
SLOT NO MANUAL	3.22
Spectrum due to modulation	3.56
Spectrum due to transients	3.66
Spurious emissions	3.71
Static Power Control Level	3.18

T

TDMA burst	3.22, 3.51
Test parameters	3.9
Test setup	
Spectrum due to modulation	3.59
Spurious emissions	3.74
TX BAND	3.72
Timeslot	3.22
Training sequence	3.21
Transmission channel	3.13
Transmission system	3.9
Trigger signal (external)	3.22
Trigger source	3.23
TSC (Training Sequence Code)	3.21
TX band	3.75



Before putting the product into operation for the first time, make sure to read the following



Safety Instructions

Rohde & Schwarz makes every effort to keep the safety standard of its products up to date and to offer its customers the highest possible degree of safety. Our products and the auxiliary equipment required for them are designed and tested in accordance with the relevant safety standards. Compliance with these standards is continuously monitored by our quality assurance system. This product has been designed and tested in accordance with the EC Certificate of Conformity and has left the manufacturer's plant in a condition fully complying with safety standards. To maintain this condition and to ensure safe operation, observe all instructions and warnings provided in this manual. If you have any questions regarding these safety instructions, Rohde & Schwarz will be happy to answer them.

Furthermore, it is your responsibility to use the product in an appropriate manner. This product is designed for use solely in industrial and laboratory environments or in the field and must not be used in any way that may cause personal injury or property damage. You are responsible if the product is used for an intention other than its designated purpose or in disregard of the manufacturer's instructions. The manufacturer shall assume no responsibility for such use of the product.

The product is used for its designated purpose if it is used in accordance with its operating manual and within its performance limits (see data sheet, documentation, the following safety instructions). Using the products requires technical skills and knowledge of English. It is therefore essential that the products be used exclusively by skilled and specialized staff or thoroughly trained personnel with the required skills. If personal safety gear is required for using Rohde & Schwarz products, this will be indicated at the appropriate place in the product documentation.

Symbols and safety labels

Observe operating instructions	Weight indication for units >18 kg	Danger of electric shock	Warning! Hot surface	PE terminal	Ground	Ground terminal	Attention! Electrostatic sensitive devices

Supply voltage ON/OFF	Standby indication	Direct current (DC)	Alternating current (AC)	Direct/alternating current (DC/AC)	Device fully protected by double/reinforced insulation

Safety Instructions

Observing the safety instructions will help prevent personal injury or damage of any kind caused by dangerous situations. Therefore, carefully read through and adhere to the following safety instructions before putting the product into operation. It is also absolutely essential to observe the additional safety instructions on personal safety that appear in other parts of the documentation. In these safety instructions, the word "product" refers to all merchandise sold and distributed by Rohde & Schwarz, including instruments, systems and all accessories.

Tags and their meaning

DANGER	This tag indicates a safety hazard with a high potential of risk for the user that can result in death or serious injuries.
WARNING	This tag indicates a safety hazard with a medium potential of risk for the user that can result in death or serious injuries.
CAUTION	This tag indicates a safety hazard with a low potential of risk for the user that can result in slight or minor injuries.
ATTENTION	This tag indicates the possibility of incorrect use that can cause damage to the product.
NOTE	This tag indicates a situation where the user should pay special attention to operating the product but which does not lead to damage.

These tags are in accordance with the standard definition for civil applications in the European Economic Area. Definitions that deviate from the standard definition may also exist. It is therefore essential to make sure that the tags described here are always used only in connection with the associated documentation and the associated product. The use of tags in connection with unassociated products or unassociated documentation can result in misinterpretations and thus contribute to personal injury or material damage.

Basic safety instructions

1. The product may be operated only under the operating conditions and in the positions specified by the manufacturer. Its ventilation must not be obstructed during operation. Unless otherwise specified, the following requirements apply to Rohde & Schwarz products:
prescribed operating position is always with the housing floor facing down, IP protection 2X, pollution severity 2, overvoltage category 2, use only in enclosed spaces, max. operation altitude max. 2000 m. Unless specified otherwise in the data sheet, a tolerance of $\pm 10\%$ shall apply to the nominal voltage and of $\pm 5\%$ to the nominal frequency.
2. Applicable local or national safety regulations and rules for the prevention of accidents must be observed in all work performed. The product may be opened only by authorized, specially trained personnel. Prior to performing any work on the product or opening the product, the product must be disconnected from the supply network. Any adjustments, replacements of parts, maintenance or repair must be carried out only by technical personnel authorized by Rohde & Schwarz. Only original parts may be used for replacing parts relevant to safety (e.g. power switches, power transformers, fuses). A safety test must always be performed after parts relevant to safety have been replaced (visual inspection, PE conductor test, insulation resistance measurement, leakage current measurement, functional test).
3. As with all industrially manufactured goods, the use of substances that induce an allergic reaction (allergens, e.g. nickel) such as aluminum cannot be generally excluded. If you develop an allergic reaction (such as a skin rash, frequent sneezing, red eyes or respiratory difficulties), consult a physician immediately to determine the cause.

Safety Instructions

4. If products/components are mechanically and/or thermally processed in a manner that goes beyond their intended use, hazardous substances (heavy-metal dust such as lead, beryllium, nickel) may be released. For this reason, the product may only be disassembled, e.g. for disposal purposes, by specially trained personnel. Improper disassembly may be hazardous to your health. National waste disposal regulations must be observed.
5. If handling the product yields hazardous substances or fuels that must be disposed of in a special way, e.g. coolants or engine oils that must be replenished regularly, the safety instructions of the manufacturer of the hazardous substances or fuels and the applicable regional waste disposal regulations must be observed. Also observe the relevant safety instructions in the product documentation.
6. Depending on the function, certain products such as RF radio equipment can produce an elevated level of electromagnetic radiation. Considering that unborn life requires increased protection, pregnant women should be protected by appropriate measures. Persons with pacemakers may also be endangered by electromagnetic radiation. The employer is required to assess workplaces where there is a special risk of exposure to radiation and, if necessary, take measures to avert the danger.
7. Operating the products requires special training and intense concentration. Make certain that persons who use the products are physically, mentally and emotionally fit enough to handle operating the products; otherwise injuries or material damage may occur. It is the responsibility of the employer to select suitable personnel for operating the products.
8. Prior to switching on the product, it must be ensured that the nominal voltage setting on the product matches the nominal voltage of the AC supply network. If a different voltage is to be set, the power fuse of the product may have to be changed accordingly.
9. In the case of products of safety class I with movable power cord and connector, operation is permitted only on sockets with earthing contact and protective earth connection.
10. Intentionally breaking the protective earth connection either in the feed line or in the product itself is not permitted. Doing so can result in the danger of an electric shock from the product. If extension cords or connector strips are implemented, they must be checked on a regular basis to ensure that they are safe to use.
11. If the product has no power switch for disconnection from the AC supply, the plug of the connecting cable is regarded as the disconnecting device. In such cases, it must be ensured that the power plug is easily reachable and accessible at all times (length of connecting cable approx. 2 m). Functional or electronic switches are not suitable for providing disconnection from the AC supply. If products without power switches are integrated in racks or systems, a disconnecting device must be provided at the system level.
12. Never use the product if the power cable is damaged. By taking appropriate safety measures and carefully laying the power cable, ensure that the cable cannot be damaged and that no one can be hurt by e.g. tripping over the cable or suffering an electric shock.
13. The product may be operated only from TN/TT supply networks fused with max. 16 A.
14. Do not insert the plug into sockets that are dusty or dirty. Insert the plug firmly and all the way into the socket. Otherwise this can result in sparks, fire and/or injuries.
15. Do not overload any sockets, extension cords or connector strips; doing so can cause fire or electric shocks.
16. For measurements in circuits with voltages $V_{rms} > 30 V$, suitable measures (e.g. appropriate measuring equipment, fusing, current limiting, electrical separation, insulation) should be taken to avoid any hazards.
17. Ensure that the connections with information technology equipment comply with IEC 950/EN 60950.
18. Never remove the cover or part of the housing while you are operating the product. This will expose circuits and components and can lead to injuries, fire or damage to the product.

Safety Instructions

19. If a product is to be permanently installed, the connection between the PE terminal on site and the product's PE conductor must be made first before any other connection is made. The product may be installed and connected only by a skilled electrician.
20. For permanently installed equipment without built-in fuses, circuit breakers or similar protective devices, the supply circuit must be fused in such a way that suitable protection is provided for users and products.
21. Do not insert any objects into the openings in the housing that are not designed for this purpose. Never pour any liquids onto or into the housing. This can cause short circuits inside the product and/or electric shocks, fire or injuries.
22. Use suitable overvoltage protection to ensure that no overvoltage (such as that caused by a thunderstorm) can reach the product. Otherwise the operating personnel will be endangered by electric shocks.
23. Rohde & Schwarz products are not protected against penetration of water, unless otherwise specified (see also safety instruction 1.). If this is not taken into account, there exists the danger of electric shock or damage to the product, which can also lead to personal injury.
24. Never use the product under conditions in which condensation has formed or can form in or on the product, e.g. if the product was moved from a cold to a warm environment.
25. Do not close any slots or openings on the product, since they are necessary for ventilation and prevent the product from overheating. Do not place the product on soft surfaces such as sofas or rugs or inside a closed housing, unless this is well ventilated.
26. Do not place the product on heat-generating devices such as radiators or fan heaters. The temperature of the environment must not exceed the maximum temperature specified in the data sheet.
27. Batteries and storage batteries must not be exposed to high temperatures or fire. Keep batteries and storage batteries away from children. If batteries or storage batteries are improperly replaced, this can cause an explosion (warning: lithium cells). Replace the battery or storage battery only with the matching Rohde & Schwarz type (see spare parts list). Batteries and storage batteries are hazardous waste. Dispose of them only in specially marked containers. Observe local regulations regarding waste disposal. Do not short-circuit batteries or storage batteries.
28. Please be aware that in the event of a fire, toxic substances (gases, liquids etc.) that may be hazardous to your health may escape from the product.
29. Please be aware of the weight of the product. Be careful when moving it; otherwise you may injure your back or other parts of your body.
30. Do not place the product on surfaces, vehicles, cabinets or tables that for reasons of weight or stability are unsuitable for this purpose. Always follow the manufacturer's installation instructions when installing the product and fastening it to objects or structures (e.g. walls and shelves).
31. Handles on the products are designed exclusively for personnel to hold or carry the product. It is therefore not permissible to use handles for fastening the product to or on means of transport such as cranes, fork lifts, wagons, etc. The user is responsible for securely fastening the products to or on the means of transport and for observing the safety regulations of the manufacturer of the means of transport. Noncompliance can result in personal injury or material damage.
32. If you use the product in a vehicle, it is the sole responsibility of the driver to drive the vehicle safely. Adequately secure the product in the vehicle to prevent injuries or other damage in the event of an accident. Never use the product in a moving vehicle if doing so could distract the driver of the vehicle. The driver is always responsible for the safety of the vehicle; the manufacturer assumes no responsibility for accidents or collisions.
33. If a laser product (e.g. a CD/DVD drive) is integrated in a Rohde & Schwarz product, do not use any other settings or functions than those described in the documentation. Otherwise this may be hazardous to your health, since the laser beam can cause irreversible damage to your eyes. Never try to take such products apart, and never look into the laser beam.



Por favor lea imprescindiblemente antes de la primera puesta en funcionamiento las siguientes informaciones de seguridad



Informaciones de seguridad

Es el principio de Rohde & Schwarz de tener a sus productos siempre al día con los estándares de seguridad y de ofrecer a sus clientes el máximo grado de seguridad. Nuestros productos y todos los equipos adicionales son siempre fabricados y examinados según las normas de seguridad vigentes. Nuestra sección de gestión de la seguridad de calidad controla constantemente que sean cumplidas estas normas. Este producto ha sido fabricado y examinado según el comprobante de conformidad adjunto según las normas de la CE y ha salido de nuestra planta en estado impecable según los estándares técnicos de seguridad. Para poder preservar este estado y garantizar un funcionamiento libre de peligros, deberá el usuario atenerse a todas las informaciones, informaciones de seguridad y notas de alerta. Rohde&Schwarz está siempre a su disposición en caso de que tengan preguntas referentes a estas informaciones de seguridad.

Además queda en la responsabilidad del usuario utilizar el producto en la forma debida. Este producto solamente fue elaborado para ser utilizado en la industria y el laboratorio o para fines de campo y de ninguna manera deberá ser utilizado de modo que alguna persona/cosa pueda ser dañada. El uso del producto fuera de sus fines definidos o despreciando las informaciones de seguridad del fabricante queda en la responsabilidad del usuario. El fabricante no se hace en ninguna forma responsable de consecuencias a causa del maluso del producto.

Se parte del uso correcto del producto para los fines definidos si el producto es utilizado dentro de las instrucciones del correspondiente manual del uso y dentro del margen de rendimiento definido (ver hoja de datos, documentación, informaciones de seguridad que siguen). El uso de los productos hace necesarios conocimientos profundos y el conocimiento del idioma inglés. Por eso se deberá tener en cuenta de exclusivamente autorizar para el uso de los productos a personas péritas o debidamente minuciosamente instruidas con los conocimientos citados. Si fuera necesaria indumentaria de seguridad para el uso de productos de R&S, encontrará la información debida en la documentación del producto en el capítulo correspondiente.

Símbolos y definiciones de seguridad

Ver manual de instrucciones del uso	Informaciones para maquinaria con un peso de > 18kg	Peligro de golpe de corriente	¡Advertencia! Superficie caliente	Conexión a conductor protector	Conexión a tierra	Conexión a masa conductora	¡Cuidado! Elementos de construcción con peligro de carga electrostática

potencia EN MARCHA/PARADA	Indicación Stand-by	Corriente continua DC	Corriente alterna AC	Corriente continua/alterna DC/AC	El aparato está protegido en su totalidad por un aislamiento de doble refuerzo

Informaciones de seguridad

Tener en cuenta las informaciones de seguridad sirve para tratar de evitar daños y peligros de toda clase. Es necesario de que se lean las siguientes informaciones de seguridad concienzudamente y se tengan en cuenta debidamente antes de la puesta en funcionamiento del producto. También deberán ser tenidas en cuenta las informaciones para la protección de personas que encontrarán en otro capítulo de esta documentación y que también son obligatorias de seguir. En las informaciones de seguridad actuales hemos juntado todos los objetos vendidos por Rohde&Schwarz bajo la denominación de „producto“, entre ellos también aparatos, instalaciones así como toda clase de accesorios.

Palabras de señal y su significado

PELIGRO	Indica un punto de peligro con gran potencial de riesgo para el usuario. Punto de peligro que puede llevar hasta la muerte o graves heridas.
ADVERTENCIA	Indica un punto de peligro con un potencial de riesgo mediano para el usuario. Punto de peligro que puede llevar hasta la muerte o graves heridas .
ATENCIÓN	Indica un punto de peligro con un potencial de riesgo pequeño para el usuario. Punto de peligro que puede llevar hasta heridas leves o pequeñas
CUIDADO	Indica la posibilidad de utilizar mal el producto y a consecuencia dañarlo.
INFORMACIÓN	Indica una situación en la que deberían seguirse las instrucciones en el uso del producto, pero que no consecuentemente deben de llevar a un daño del mismo.

Las palabras de señal corresponden a la definición habitual para aplicaciones civiles en el ámbito de la comunidad económica europea. Pueden existir definiciones diferentes a esta definición. Por eso se debiera tener en cuenta que las palabras de señal aquí descritas sean utilizadas siempre solamente en combinación con la correspondiente documentación y solamente en combinación con el producto correspondiente. La utilización de las palabras de señal en combinación con productos o documentaciones que no les correspondan puede llevar a malinterpretaciones y tener por consecuencia daños en personas u objetos.

Informaciones de seguridad elementales

1. El producto solamente debe ser utilizado según lo indicado por el fabricante referente a la situación y posición de funcionamiento sin que se obstruya la ventilación. Si no se convino de otra manera, es para los productos R&S válido lo que sigue: como posición de funcionamiento se define principalmente la posición con el suelo de la caja para abajo , modo de protección IP 2X, grado de suciedad 2, categoría de sobrecarga eléctrica 2, utilizar solamente en estancias interiores, utilización hasta 2000 m sobre el nivel del mar.
A menos que se especifique otra cosa en la hoja de datos, se aplicará una tolerancia de $\pm 10\%$ sobre el voltaje nominal y de $\pm 5\%$ sobre la frecuencia nominal.
2. En todos los trabajos deberán ser tenidas en cuenta las normas locales de seguridad de trabajo y de prevención de accidentes. El producto solamente debe de ser abierto por personal périto autorizado. Antes de efectuar trabajos en el producto o abrirlo deberá este ser desconectado de la corriente. El ajuste, el cambio de partes, la manutención y la reparación deberán ser solamente efectuadas por electricistas autorizados por R&S. Si se reponen partes con importancia para los aspectos de seguridad (por ejemplo el enchufe, los transformadores o los fusibles), solamente podrán ser sustituidos por partes originales. Despues de cada recambio de partes elementales para la seguridad deberá ser efectuado un control de

Informaciones de seguridad

- seguridad (control a primera vista, control de conductor protector, medición de resistencia de aislamiento, medición de medición de la corriente conductora, control de funcionamiento).
3. Como en todo producto de fabricación industrial no puede ser excluido en general de que se produzcan al usarlo elementos que puedan generar alergias, los llamados elementos alergénicos (por ejemplo el níquel). Si se produjeran en el trato con productos R&S reacciones alérgicas, como por ejemplo urticaria, estornudos frecuentes, irritación de la conjuntiva o dificultades al respirar, se deberá consultar inmediatamente a un médico para averiguar los motivos de estas reacciones.
 4. Si productos / elementos de construcción son tratados fuera del funcionamiento definido de forma mecánica o térmica, pueden generarse elementos peligrosos (polvos de sustancia de metales pesados como por ejemplo plomo, berilio, níquel). La partición elemental del producto, como por ejemplo sucede en el tratamiento de materias residuales, debe de ser efectuada solamente por personal especializado para estos tratamientos. La partición elemental efectuada inadecuadamente puede generar daños para la salud. Se deben tener en cuenta las directivas nacionales referentes al tratamiento de materias residuales.
 5. En el caso de que se produjeran agentes de peligro o combustibles en la aplicación del producto que debieran de ser transferidos a un tratamiento de materias residuales, como por ejemplo agentes refrigerantes que deben ser repuestos en periodos definidos, o aceites para motores, deberán ser tenidas en cuenta las prescripciones de seguridad del fabricante de estos agentes de peligro o combustibles y las regulaciones regionales para el tratamiento de materias residuales. Cuiden también de tener en cuenta en caso dado las prescripciones de seguridad especiales en la descripción del producto.
 6. Ciertos productos, como por ejemplo las instalaciones de radiación HF, pueden a causa de su función natural, emitir una radiación electromagnética aumentada. En vista a la protección de la vida en desarrollo deberían ser protegidas personas embarazadas debidamente. También las personas con un bypass pueden correr peligro a causa de la radiación electromagnética. El empresario está comprometido a valorar y señalar áreas de trabajo en las que se corra un riesgo de exposición a radiaciones aumentadas de riesgo aumentado para evitar riesgos.
 7. La utilización de los productos requiere instrucciones especiales y una alta concentración en el manejo. Debe de ponerse por seguro de que las personas que manejen los productos estén a la altura de los requerimientos necesarios referente a sus aptitudes físicas, psíquicas y emocionales, ya que de otra manera no se pueden excluir lesiones o daños de objetos. El empresario lleva la responsabilidad de seleccionar el personal usuario apto para el manejo de los productos.
 8. Antes de la puesta en marcha del producto se deberá tener por seguro de que la tensión preseleccionada en el producto equivalga a la del la red de distribución. Si es necesario cambiar la preselección de la tensión también se deberán en caso dabo cambiar los fusibles correspondientes del producto.
 9. Productos de la clase de seguridad I con alimentación móvil y enchufe individual de producto solamente deberán ser conectados para el funcionamiento a tomas de corriente de contacto de seguridad y con conductor protector conectado.
 10. Queda prohibida toda clase de interrupción intencionada del conductor protector, tanto en la toma de corriente como en el mismo producto ya que puede tener como consecuencia el peligro de golpe de corriente por el producto. Si se utilizaran cables o enchufes de extensión se deberá poner al seguro, que es controlado su estado técnico de seguridad.
 11. Si el producto no está equipado con un interruptor para desconectarlo de la red, se deberá considerar el enchufe del cable de distribución como interruptor. En estos casos deberá asegurar de que el enchufe sea de fácil acceso y nabejo (medida del cable de distribución aproximadamente 2 m). Los interruptores de función o electrónicos no son aptos para el corte de la red eléctrica. Si los productos sin interruptor están integrados en construcciones o instalaciones, se deberá instalar el interruptor al nivel de la instalación.

Informaciones de seguridad

12. No utilice nunca el producto si está dañado el cable eléctrico. Asegure a través de las medidas de protección y de instalación adecuadas de que el cable de eléctrico no pueda ser dañado o de que nadie pueda ser dañado por él, por ejemplo al tropezar o por un golpe de corriente.
13. Solamente está permitido el funcionamiento en redes de distribución TN/TT aseguradas con fusibles de como máximo 16 A.
14. Nunca conecte el enchufe en tomas de corriente sucias o llenas de polvo. Introduzca el enchufe por completo y fuertemente en la toma de corriente. Si no tiene en consideración estas indicaciones se arriesga a que se originen chispas, fuego y/o heridas.
15. No sobrecargue las tomas de corriente, los cables de extensión o los enchufes de extensión ya que esto pudiera causar fuego o golpes de corriente.
16. En las mediciones en circuitos de corriente con una tensión de entrada de $U_{eff} > 30 \text{ V}$ se deberá tomar las precauciones debidas para impedir cualquier peligro (por ejemplo medios de medición adecuados, seguros, limitación de tensión, corte protector, aislamiento etc.).
17. En caso de conexión con aparatos de la técnica informática se deberá tener en cuenta que estos cumplan los requisitos de la EC950/EN60950.
18. Nunca abra la tapa o parte de ella si el producto está en funcionamiento. Esto pone a descubierto los cables y componentes eléctricos y puede causar heridas, fuego o daños en el producto.
19. Si un producto es instalado fijamente en un lugar, se deberá primero conectar el conductor protector fijo con el conductor protector del aparato antes de hacer cualquier otra conexión. La instalación y la conexión deberán ser efectuadas por un electricista especializado.
20. En caso de que los productos que son instalados fijamente en un lugar sean sin protector implementado, autointerruptor o similares objetos de protección, deberá la toma de corriente estar protegida de manera que los productos o los usuarios estén suficientemente protegidos.
21. Por favor, no introduzca ningún objeto que no esté destinado a ello en los orificios de la caja del aparato. No vierta nunca ninguna clase de líquidos sobre o en la caja. Esto puede producir corto circuitos en el producto y/o puede causar golpes de corriente, fuego o heridas.
22. Asegúrese con la protección adecuada de que no pueda originarse en el producto una sobrecarga por ejemplo a causa de una tormenta. Si no se verá el personal que lo utilice expuesto al peligro de un golpe de corriente.
23. Los productos R&S no están protegidos contra el agua si no es que exista otra indicación, ver también punto 1. Si no se tiene en cuenta esto se arriesga el peligro de golpe de corriente o de daños en el producto lo cual también puede llevar al peligro de personas.
24. No utilice el producto bajo condiciones en las que pueda producirse y se hayan producido líquidos de condensación en o dentro del producto como por ejemplo cuando se desplaza el producto de un lugar frío a un lugar caliente.
25. Por favor no cierre ninguna ranura u orificio del producto, ya que estas son necesarias para la ventilación e impiden que el producto se caliente demasiado. No pongan el producto encima de materiales blandos como por ejemplo sofás o alfombras o dentro de una caja cerrada, si esta no está suficientemente ventilada.
26. No ponga el producto sobre aparatos que produzcan calor, como por ejemplo radiadores o calentadores. La temperatura ambiental no debe superar la temperatura máxima especificada en la hoja de datos.

Informaciones de seguridad

27. Baterías y acumuladores no deben de ser expuestos a temperaturas altas o al fuego. Guardar baterías y acumuladores fuera del alcance de los niños. Si las baterías o los acumuladores no son cambiados con la debida atención existirá peligro de explosión (atención celulas de Litio). Cambiar las baterías o los acumuladores solamente por los del tipo R&S correspondiente (ver lista de piezas de recambio). Baterías y acumuladores son deshechos problemáticos. Por favor tirenlos en los recipientes especiales para este fin. Por favor tengan en cuenta las prescripciones nacionales de cada país referente al tratamiento de deshechos. Nunca sometan las baterías o acumuladores a un corto circuito.
28. Tengan en consideración de que en caso de un incendio pueden escaparse gases tóxicos del producto, que pueden causar daños a la salud.
29. Por favor tengan en cuenta que en caso de un incendio pueden desprenderse del producto agentes venenosos (gases, líquidos etc.) que pueden generar daños a la salud.
30. No sitúe el producto encima de superficies, vehículos, estantes o mesas, que por sus características de peso o de estabilidad no sean aptas para él. Siga siempre las instrucciones de instalación del fabricante cuando instale y asegure el producto en objetos o estructuras (por ejemplo paredes y estantes).
31. Las asas instaladas en los productos sirven solamente de ayuda para el manejo que solamente está previsto para personas. Por eso no está permitido utilizar las asas para la sujecion en o sobre medios de transporte como por ejemplo grúas, carretillas elevadoras de horquilla, carros etc. El usuario es responsable de que los productos sean sujetados de forma segura a los medios de transporte y de que las prescripciones de seguridad del fabricante de los medios de transporte sean tenidas en cuenta. En caso de que no se tengan en cuenta pueden causarse daños en personas y objetos.
32. Si llega a utilizar el producto dentro de un vehículo, queda en la responsabilidad absoluta del conductor que conducir el vehículo de manera segura. Asegure el producto dentro del vehículo debidamente para evitar en caso de un accidente las lesiones u otra clase de daños. No utilice nunca el producto dentro de un vehículo en movimiento si esto pudiera distraer al conductor. Siempre queda en la responsabilidad absoluta del conductor la seguridad del vehículo y el fabricante no asumirá ninguna clase de responsabilidad por accidentes o colisiones.
33. Dado el caso de que esté integrado un producto de laser en un producto R&S (por ejemplo CD/DVD-ROM) no utilice otras instalaciones o funciones que las descritas en la documentación. De otra manera pondrá en peligro su salud, ya que el rayo laser puede dañar irreversiblemente sus ojos. Nunca trate de descomponer estos productos. Nunca mire dentro del rayo laser.

1 Getting Started

This chapter is mainly intended for operators using the GSM BTS analyzer mode for the first time. Operators are guided step by step through the most frequent base station tests.

The chapter describes FSE/FSIQ setup, relevant settings and individual measurements.

Layout and content are application-oriented and provide important information on FSE/FSIQ as well as the GSM/DCS1800/PCS1900 system.

It is recommended to read through this chapter and perform the operations on the FSE/FSIQ at the same time. This ensures a simple and rapid introduction to the GSM BTS firmware functions so that correct and useful measurement results are achieved.

Some of the steps are provided with reference numbers, eg ①, relating to a more detailed information on the opposite page.

For more detailed information on the individual menus and softkeys kindly refer to the reference part in chapter 2.

Note: *The descriptions of some of the functions are provided with notes pointing out that some functions of FSE-K11 are available only if Vector Signal Analysis Option FSE-B7 is installed. These notes apply only to FSE, since FSIQ contains this option in the basic version.*

1.1 Connecting the FSE/FSIQ

1.1.1 Standard Test Setup

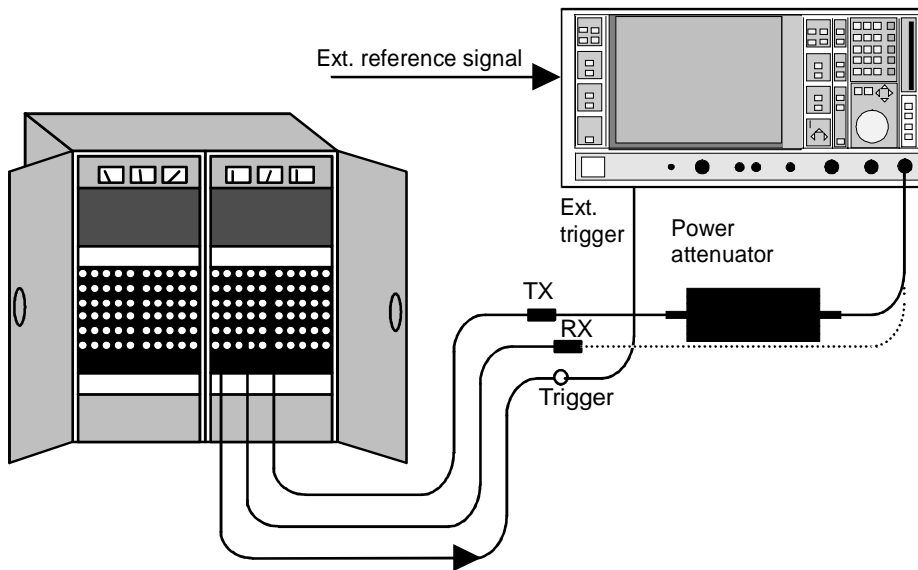

((ext. Referenzsignal = Ext. reference signal; Trigger Extern = Ext. trigger; Leistungsdämpfungsglied = Power attenuator))

Fig. 1-1 BTS with separate RX input and TX output (connections for measurements in the RX band shown as dotted lines)

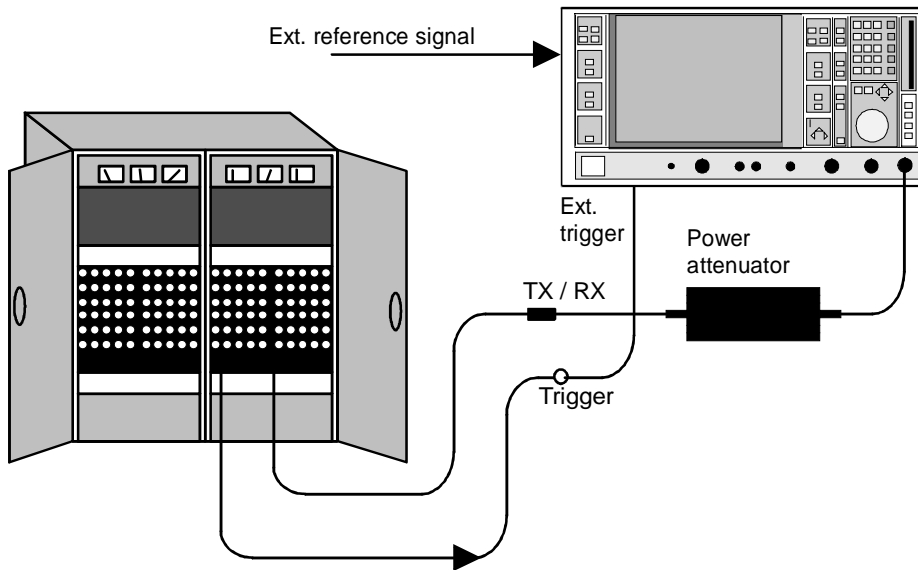

Fig. 1-2 Test setup for BTS with combined RX/TX input/output

Caution: Another test setup is required for measurements in the RX band (see sections 1.1.2 and 1.1.3)

- Connect the frame trigger output of the BTS to the rear-panel BNC connector: *EXT TRIG GATE* (external trigger or gate input) of the FSE/FSIQ. With the aid of this external trigger signal FSE/FSIQ is able to trigger exactly to any slot even if several slots of the frame are occupied.

- Connect the antenna output (or TX output) of the BTS via a suitable power attenuator to the RF input of FSE/FSIQ (except for measurements in the RX band; special test setup).

1.1.2 Test Setup for Measurements in the RX Band (Spurious ① and Modulation Spectrum)

RX-band test setup for BTSs with combined RX/TX input/output:

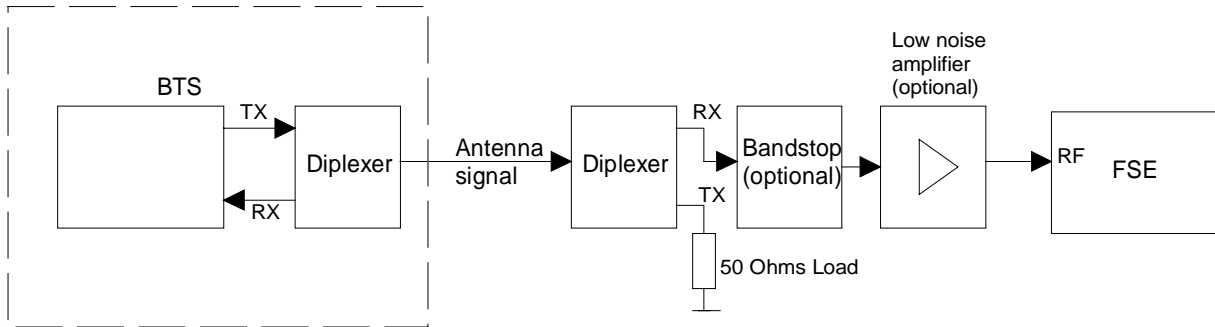

RX-band test setup for BTSs with separate RX input and TX output:

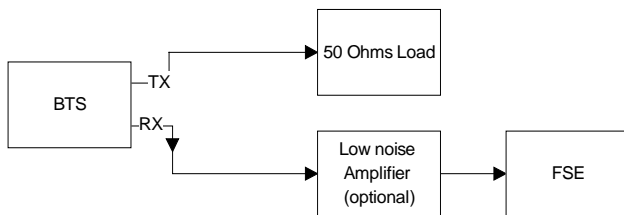

1.1.3 Test Setup for Measuring Spurious in the TX and outside the TX/RX Band (<>TX Band):

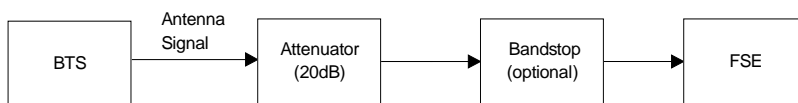

Additional information

- ① The stringent requirements for measurements of spurious in the RX band on BTSs using a combined RX input/TX output demand adequate suppression of the carrier signal(s) (max. carrier level < -10 dBm at the FSE/FSIQ input), eg with the aid of bandstop filters and/or diplexers. Since the requirements for GSM phase 1 are more severe than those for phase 2, an external low-noise preamplifier may be required in addition because of the higher noise floor of FSEB, FSEM and FSEK compared to FSEA.

With BTSs using a **separate** RX input, the TX channel is sufficiently suppressed at the RX input.

To obtain maximum sensitivity, 0 dB attenuation is selected when RX BAND is set on the FSE/FSIQ.

Softkey *RX BAND GAIN* defines the gain of the external preamplifier (or in the case of negative values the insertion loss of the preceding diplexers and bandstop filters), which is then taken into account in the FSE display.

The attenuation of the external attenuator entered under Settings is ignored when the RX band is measured.

Caution: *The level at the FSE input of +20 dBm with a 0 dB input attenuator must under no circumstances be exceeded.*

The following warning is output when the RX-BAND softkey is pressed on the screen.

Caution:

Connect bandpass or bandstop to suppress TX-band!

Notes on amplifier:

The noise figure of the preamplifier should be as low as possible (LF < approx. 6 dB) and the gain in the range 15 to 25 dB so that the noise floor of FSE/FSIQ (approx. 15 to 17 dB with FSEA30, approx. 18 to 21 dB with FSEB/M/K30) can be neglected.

Make sure that the preamplifier is not overdriven by insufficiently suppressed TX signals (for this reason the amplifier gain should not be too high).

1.2 Presetting the FSE/FSIQ

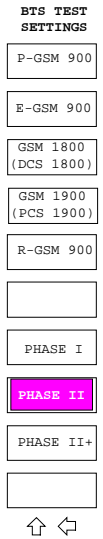
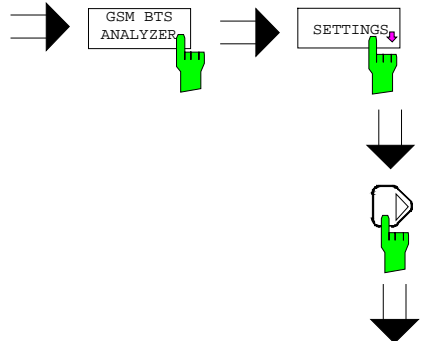
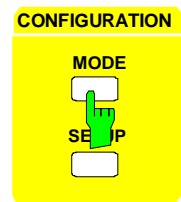
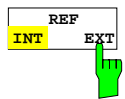
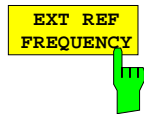
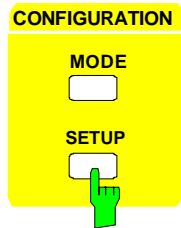

Step 1

Setting reference frequency

- Press SETUP key.
- Press softkey *EXT. REF FREQUENCY* ① and enter the frequency depending on the available frequency standard.
- Switch softkey *REF INT/EXT* to EXT (external reference frequency).

Step 2

Selecting the standard

- Press the *MODE* key and softkeys *GSM BTS ANALYZER* and *SETTINGS* one after the other and then . The menu for selecting the various standards is displayed.

Additional information**Step 1**

- ① To attain the required frequency accuracy in the frequency error measurement (*PHASE/FREQ ERROR*) a highly accurate (deviation $< 1 \cdot 10^{-9}$) external reference frequency $n \times 1$ MHz with $n = 1, 2, \dots, 16$ has to be applied to the FSE/FSIQ.

Step 3

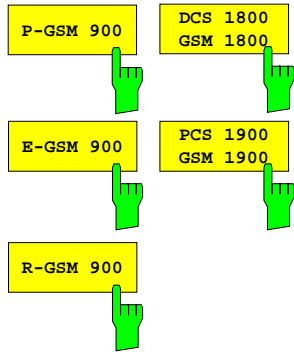

- Select standard P-GSM900, E-GSM900, DCS 1800, PCS 1900 or R-GSM, depending on the BTS to be tested.

with GSM900 and DCS1800:

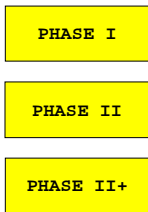

- Select between Phase I, II or II+. With some standards, the softkeys are not available (PCS 1900) or partly available because no phases or not all of them are defined.

Press  to return to the SETTINGS menu.

Step 4

Entering the external attenuation

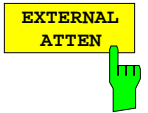

- Press the *EXTERNAL ATTEN* softkey.
- Enter the external attenuation. (For recommended attenuation see ②)

Additional information**Step 4**

- ② The following values are recommended for the external attenuator to ensure that the FSE/FSIQ RF input is protected and the sensitivity of the FSE/FSIQ is not reduced too much. The FSE/FSIQ level display is automatically corrected by the entered value.

Max. power	Recommended ext. attenuation
≥ 55 to 60 dBm	35 to 40 dB
≥ 50 to 55 dBm	30 to 35 dB
≥ 45 to 50 dBm	25 to 30 dB
≥ 40 to 45 dBm	20 to 25 dB
≥ 35 to 40 dBm	15 to 20 dB
≥ 30 to 35 dBm	10 to 15 dB
≥ 25 to 30 dBm	5 to 10 dB
≥ 20 to 25 dBm	0 to 5 dB
< 20 dBm	0 dB

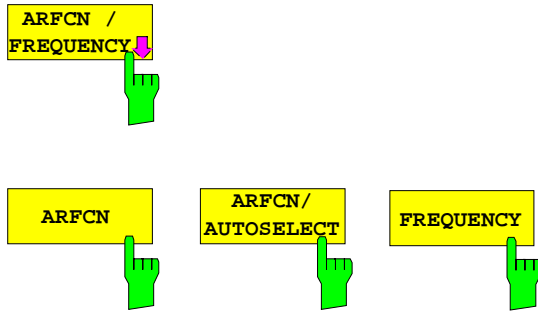

Step 5

Selecting the transmission channel

- Press the *ARFCN / FREQUENCY* softkey.
- Press softkey *ARFCN*, *ARFCN AUTOSELECT* or *FREQUENCY*.

With *ARFCN* selected:

- Enter the transmission channel number of your base station. ③
FSE/FSIQ will tune to this frequency in compliance with the selected standard.

With *ARFCN AUTOSELECT*, FSE/FSIQ automatically searches for the active transmission channel on condition that frequency hopping is not active.

With *FREQUENCY* selected:

- Enter the transmission frequency of your base station or any other frequency (eg the IF of a BTS module).
Frequencies of the following range are permissible:
 $1.8\text{MHz} \leq \text{frequency} \leq (\text{maximum device frequency} - 1.8\text{MHz})$.
- Press  to return to the *SETTINGS* menu.

Additional information

Step 5

- ③ Enter one of the possible channel numbers 1 to 124 for the P-GSM frequency range. Enter a number between 975 and 1023 or 0 for the extended GSM band. For PCN (DCS1800) the numbers 512 to 885 are available, for PCS1900 numbers 512 to 810. For R-GSM channel numbers 955 to 1023 and 0 are available in addition to the numbers of the P-GSM band (1 to 124).

Range	Channel number n	Frequency downlink (BS-->MS)	Duplex offset
P-GSM	1 to 124	$f = 890 \text{ MHz} + (n \times 0.2 \text{ MHz})$	+45 MHz
E-GSM	0 to 124	$f = 890 \text{ MHz} + (n \times 0.2 \text{ MHz})$	+45 MHz
	975 to 1023	$f = 890 \text{ MHz} + ((n - 1024) \times 0.2 \text{ MHz})$	+45 MHz
DCS1800	512 to 885	$f = 1710.2 \text{ MHz} + ((n - 512) \times 0.2 \text{ MHz})$	+95 MHz
PCS1900	512 to 810	$f = 1850.2 \text{ MHz} + ((n - 512) \times 0.2 \text{ MHz})$	+80 MHz
R-GSM	0 to 124	$f = 890 \text{ MHz} + (n \times 0.2 \text{ MHz})$	+45 MHz
	955 to 1023	$f = 890 \text{ MHz} + ((n - 1024) \times 0.2 \text{ MHz})$	+45 MHz

P-GSM 900	935.2MHz				959.8MHz	FREQ ARFCN
	1				124	
E-GSM 900	925.2MHz	934.8	935	935.2	959.8MHz	FREQ ARFCN
	975	1023	0	1	124	
R-GSM 900	921.2MHz	934.8	935	935.2	959.8MHz	FREQ ARFCN
	955	1023	0	1	124	
DCS 1800	1805.2MHz				1879.8MHz	FREQ ARFCN
	512				885	
PCS 1900	1930.2MHz				1989.8MHz	FREQ ARFCN
	512				810	

Step 6

Setting FSE/FSIQ to output power of BTS

- Press softkey *OUTPUT POWER* or *POWER CLASS* and enter the maximum output power or power class of the BTS. ④
- As an alternative enter the nominal power of the BTS by pressing softkey *NOMINAL OUTPUT PWR*.

In addition, it is possible to enter the power linked neither to a power class nor to a power control level. For this select *LIMIT/PWR COUPLED OFF* and enter the power using softkey *SIGNAL POWER*.

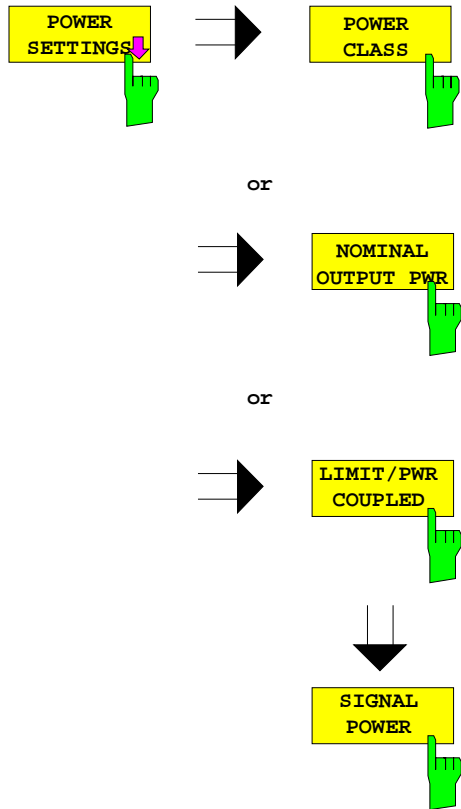

Additional information

Step 6

- ④ The power classes which can be allocated to the various standards and the associated peak power values are indicated in the following tables:

Power Class	Peak power			
	-GSM 900 - Phase 1	P-GSM 900 - Phase 2	E-GSM 900 - Phase 2 and R-GSM	DCS1800 - Phase 1
1	320W (55 dBm)	320W (55 dBm) - < 640W	320W (55 dBm) - < 640W	20 W (43 dBm)
2	160W (52 dBm)	160W (52 dBm) - < 320W	160W (52 dBm) - < 320W	10 W (40 dBm)
3	80 W (49 dBm)	80 W (49 dBm) - < 160W	80 W (49 dBm) - < 160W	5 W (37 dBm)
4	40 W (46 dBm)	40 W (46 dBm) - < 80W	40 W (46 dBm) - < 80W	2.5 W (34 dBm)
5	20W (43 dBm)	20W (43 dBm) - < 40W	20W (43 dBm) - < 40W	--
6	10W (40 dBm)	10W (40 dBm) - < 20W	10W (40 dBm) - < 20W	--
7	5W (37 dBm)	5W (37 dBm) - < 10W	5W (37 dBm) - < 10W	--
8	2.5W (34 dBm)	2.5W (34 dBm) - < 5W	2.5W (34 dBm) - < 5W	--
M1	--	(>0.08) - 0.25 W (> 19) - 24 dBm	(>0.08) - 0.25 W (> 19) - 24 dBm	--
M2	--	(>0.03) - 0.08 W (> 14) - 19 dBm	(0.03) - 0.08 W (> 14) - 19 dBm	--
M3	--	(>0.01) - 0.03W (> 9) - 14 dBm	(>0.01) - 0.03W (> 9) - 14 dBm	--

Power Class	Peak power			
	DCS1800 -		PCS1900 (Watt)	PCS1900 (dBm)
1	20 - (<40 W)	43 - < 46 dBm	20≤P0≤40	43≤P0≤46
2	10 - (<20 W)	40 - < 43 dBm	10≤P0≤20	40≤P0≤43
3	5 - (< 10 W)	37 - < 40 dBm	5≤P0≤10	37≤P0≤40
4	2.5 - (<5 W)	34 - < 37 dBm	2≤P0≤5	33≤P0≤37
5	--			
6	--	0.5≤P0≤1.6	27≤P0≤32	
7	--	0.16≤P0≤0.5	22≤P0≤27	
8	--	0.05≤P0≤0.16	17≤P0≤22	
M1	(>0.5) - 1.6 W	(>27) - 32 dBm		
M2	(>0.16) - 0.5 W	(>22) - 27 dBm		
M3	(>0.05) - 0.16 W	(>17) - 22 dBm		

To protect the FSE/FSIQ, the settings made in the POWER menu are automatically checked to make sure that the input level at the FSE/FSIQ does not exceed 27 dBm.

To prevent the occurrence of an overload, a warning is displayed for those settings which would lead to the threshold level being exceeded (*POWER CLASS*, *EXTERNAL ATTEN*, *OUTPUT MS POWER*, *POWER CTRL LEVEL*) and the set value is ignored.

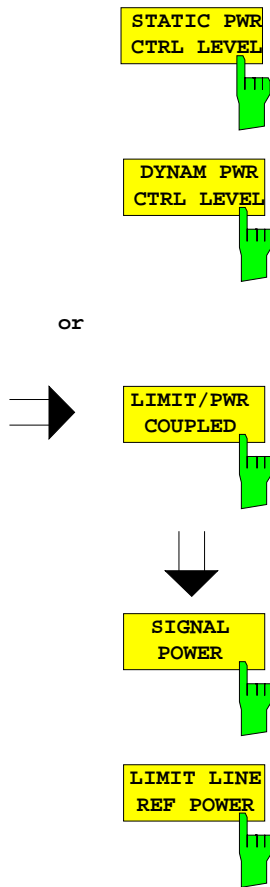

Step 7

With reduced level of the BTS enter the static and/or the dynamic power control level in addition. (The default setting is 0) ⑤:

- Enter the desired static power control level N (integer, N = 0, 1, 2 to 6). ⑤.
- Enter the desired dynamic power control level N (integer, N = 0, 1, 2 to 15). ⑥

The coupling between power and that of the power class as well as between the power actually applied and the limits selected with respect to this power can be suppressed (softkey *LIMIT/PWR COUPLED*).

- In this case press softkey *SIGNAL POWER* and specify the actual output power of the BTS (external attenuation is taken into account).

With softkey *LIMIT LINE REF POWER* the power determining the selection of limits can be selected.

Step 8

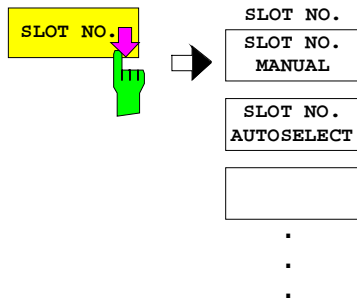

- Press softkey *SLOT NO.*
- Select the desired slot number 0 to 7 using *SLOT NO. MANUAL* or start the automatic search with *SLOT NO. AUTO SELECT*. ⑦

The FSE/FSIQ thus knows in which slot the measurement should be performed.

Additional information

Step 7

⑤

Static Power Control Level	Relative power referred to maximum output power (GSM/DCS/PCS)
0	0 dB
1	-2 dB
2	-4 dB
3	-6 dB
4	-8 dB
5	-10 dB
6	-12 dB

- ⑥ Max. 16 dynamic power control levels are specified in addition to the static power control levels. They reduce the base station level referred to the maximum output power of the base station and the static power control level in up to 16 steps of 2 dB (dynamic power control level $N = 0$ to 15, attenuation = $N \times 2$ dB).

Step 8

- ⑦ A precondition for automatic search is that only one slot is active.
(For an automatic detection of the slot the frame trigger of the base station must be connected to the external trigger input of the unit and the trigger source set to *EXTERN*, see above).

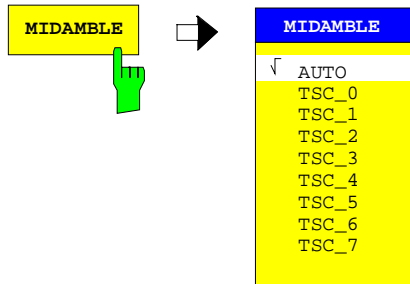

Step 9

Selecting the current midamble

- Press softkey *MIDAMBLE*. The table of training sequences (*midamble*) is displayed. ⑧

In the position AUTO (default setting) FSE uses the training sequence (midamble) according to the slot number, for instance TSC_2 for slot number 2.

- If you wish to use another training sequence, select it accordingly.

Additional information

Step 9

⑧ Table for the midamble used in the GSM system:

NAME	PATTERN (Bit No.: 61 - 86)
TSC_0	00100101110000100010010111
TSC_1	00101101110111100010110111
TSC_2	01000011101110100100001110
TSC_3	01000111101101000100011110
TSC_4	00011010111001000001101011
TSC_5	01001110101100000100111010
TSC_6	10100111110110001010011111
TSC_7	11101111000100101110111100

Step 10

Setting the trigger

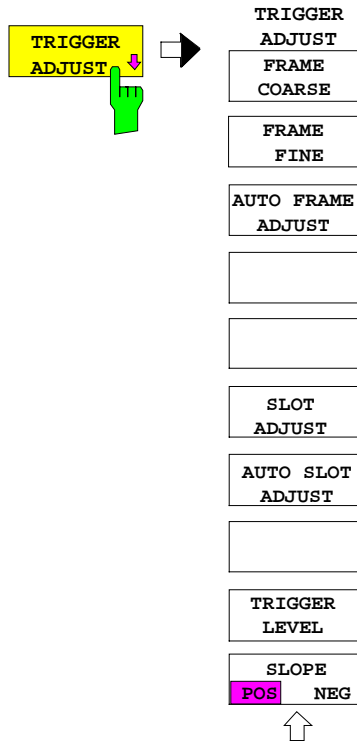
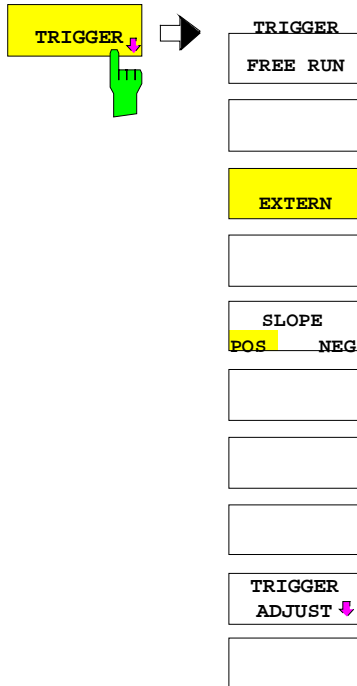

- Press softkey *TRIGGER*. An external trigger signal (frame trigger of BTS) is required for almost all measurements. The frame trigger pulse is output once for each frame. In the ideal case it comes with bit 0 in slot 0 of the frame. © But this depends on the BTS to be tested. For this reason trigger adjustment is provided (described later). The default setting for the trigger is therefore EXTERN. The default value for the external trigger level is 1.4 V but, if required, the level can be adapted by pressing *EXTERN* and then entering a new value in the data entry field. The polarity of the trigger signal can be set using softkey *SLOPE POS NEG*. Default setting: positive slope.
- Press softkey *TRIGGER ADJUST* to set the trigger reference. Automatic (preferably) or manual adjustment can be performed.

Additional information

Step 10

⑨ External frame trigger

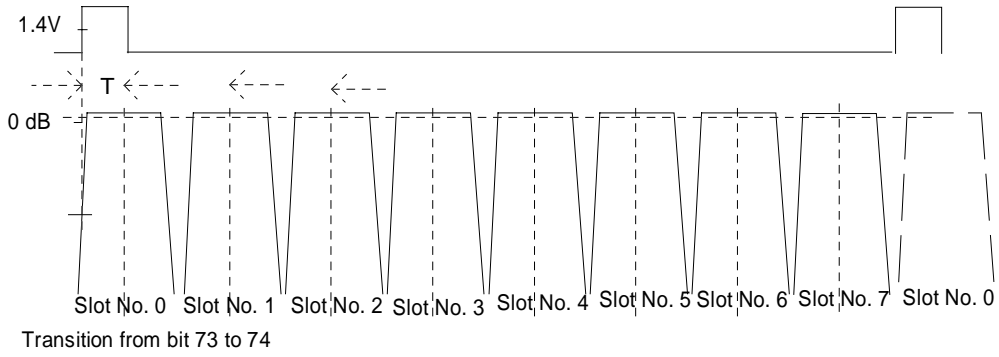

Delay between burst edge and transition bit 13/14 of midamble of slot N (where N=0,1,2...7):
 $T = 283.23 \mu s + N * 576.92 \mu s$

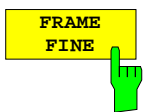
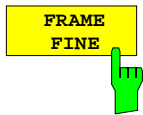
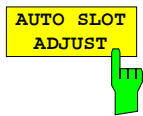
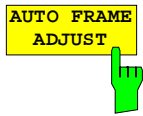

or

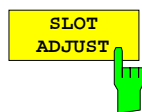

Either automatic adjustment:

Only one slot can be active.

- Press softkey *AUTO FRAME ADJUST*. FSE/FSIQ sets the time reference between trigger signal and midamble ⑩ and takes this reference into account for all measurements. *AUTO ADJUST* acts upon all slots.

If only the slot used at present is to be adjusted:

- Press softkey *AUTO SLOT ADJUST* and adjust the time reference of the slot used at present.

or manual adjustment:

(if automatic adjustment is not possible, eg with bursts without midamble or when option FSE-B7 is not installed.)

- Press softkey *FRAME COARSE* and set the time reference of the external trigger to the frame with the aid of the spinwheel (the -20 dB point of the rising burst edge should be in the display center. This point is marked by crosshairs made up of the vertical screen center line and the -20 dB line).
- Press softkey *FRAME FINE* and adjust the time reference of all slots in the same way. ⑩

If the slots have a different length (156 or 157 bits), a fine adjustment can be performed for each slot with the aid of *SLOT ADJUST*.

FSE/FSIQ is now set as required by the BTS to be measured and measurements can be started.

Additional information

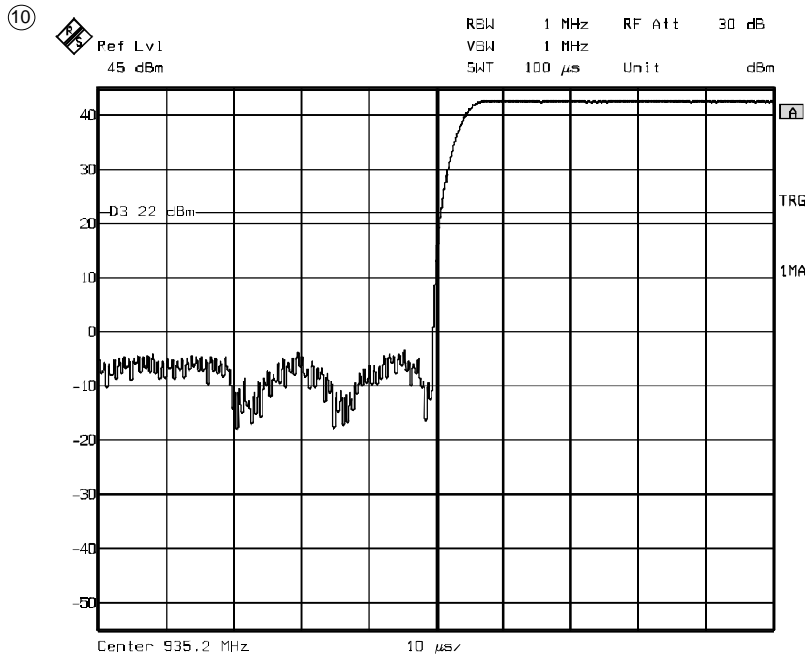
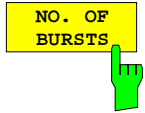
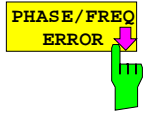

Fig 1-3 Correcting adjustment for FRAME FINE

Caution: The manual adjustment to the -20 dB point of the trigger edge can yield only an approximate time reference since the exact reference to the midamble is missing. The automatic adjustment produces the correct time reference to the midamble (depending on the steepness of the burst edge the -20 dB point can be up to approx. 7 μ s away from the screen center).

1.3 Measuring the Phase/Frequency Error ①

Note: The phase and frequency error can only be measured if the Vector Signal Analyzer option FSE-B7 is integrated.



Step 1

- Press the softkey *PHASE/FREQ ERROR*.

Step 2

- Press softkey *NO. OF BURSTS* and set the number of measurements to be carried out.
Default setting: *NO. OF BURSTS* = 1.

The number of bursts defined in the selected standard is set with SET TO STANDARD (in the phase/frequency error measurement: 20 for all standards).

Press  to return to the SETTINGS menu.

Additional information① **BTS setting:**

At least 1 slot on the selected ARFCN must be active. All slots may be occupied.

The measurement can also be performed on BTSs with active SFH (slow frequency hopping).

FSE/FSIQ measures at the set receive frequency (ARFCN). If a number of bursts > 1 is set, only results are considered at which FSE/FSIQ is able to synchronize. Thus even if the carrier frequency of the slot to be measured changes cyclically in successive frames, only slots with the set slot number at the selected ARFCN will be considered in the measurement.

However, this will considerably slow down the measurement sequence (approx. by the factor 8 against a non-hopping BTS). This disadvantage can be avoided if a trigger signal is provided for the FSE/FSIQ (triggering not on every frame but only if the selected slot is at the set ARFCN).

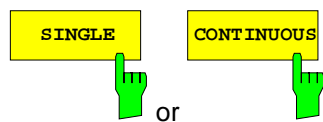
**Step 3**

- Start the measurement sequence with *SINGLE* or *CONTINUOUS*.

When the measurement is completed, an overview of the numeric modulation errors is displayed in result window A for the 147 useful bits. ②

Additional information

Step 3



Phase/Frequency Error					
ARFCN:	1				Status: FAILED
Frequency:	935.20000 MHz				
Carrier Power:	20.00 dBm	Trg to Sync Start:	256.1 μs		
Ext. Att/Gain:	20.00 dB				
Slot Nr.	0	No. of Bursts:			1
ERRORS	CURRENT	MAX HOLD	AVG	LIMIT	STATUS
Phase Pk	0.78 °	0.78 °	0.78 °	20.00 °	PASSED
Phase RMS	0.28 °	0.28 °	0.28 °	5.00 °	PASSED
Freq	-605.10 Hz*	-614.66 Hz*	-605.10 Hz*	0.05 ppm	FAILED

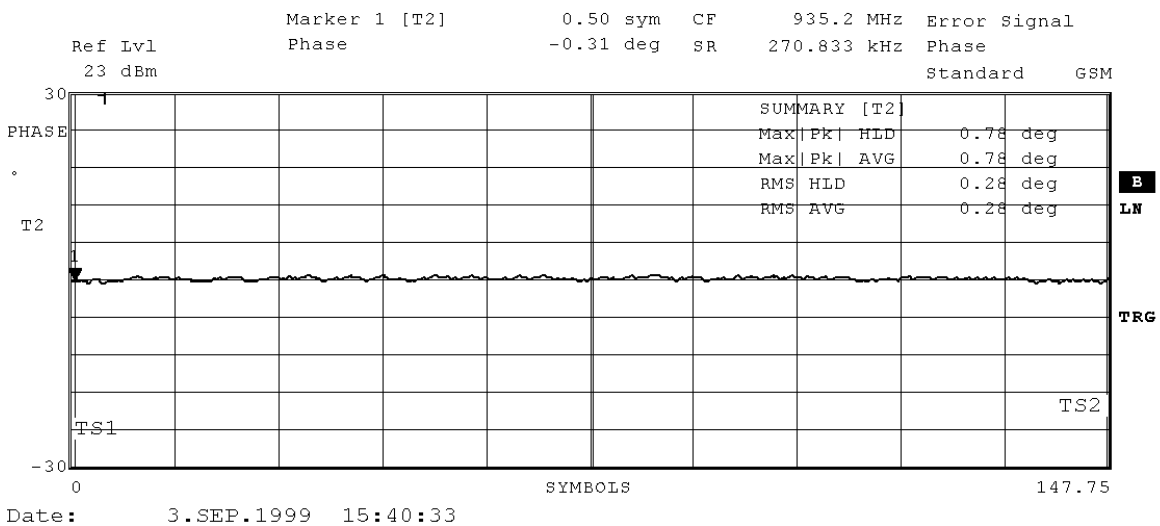

The information on instantaneous frequency and power and the following numerical results are displayed in the window. It also contains the corresponding limit values and pass/fail information.

- Max. hold and average value of peak phase error
- Max. hold and average value of rms phase error
- Max. hold and average value of frequency error

The phase error versus time is displayed in window B over the 147 useful bits of the normal burst. Three traces are simultaneously displayed.

- Trace 1: Clear Write (instantaneous phase error)
- Trace 2: Max Hold (maximum positive phase error of all measured bursts)
- Trace 3: Min Hold (maximum negative phase error of all measured bursts)

1.4 Measuring the Average Carrier Power ①

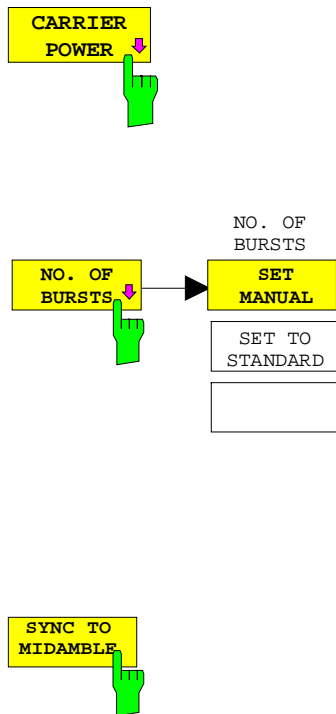

Step 1

- Press softkey *CARRIER POWER*.

Step 2

- Press softkey *NO. OF BURSTS* and set the desired number of measurements.

The number of bursts defined in the selected standard is set with SET TO STANDARD (in the carrier power measurement: 1 for all standards).

Step 3

Possible only if option FSE-B7 is installed:

In the default setting, softkey *SYNC TO MIDAMBLE* is active and thus the synchronization to the burst midamble is set. This setting is of advantage if the burst to be measured contains a midamble and a bit-accurate time reference is required. (softkey colour: green)

- Disable *SYNC TO MIDAMBLE* for bursts without midamble or if maximum measurement speed is required (softkey colour: grey) ②.

Additional information

① BTS setting:

At least three neighbouring slots of a TDMA frame of equal power must be active. If the BTS supports SFH (slow frequency hopping), SFH should be selected.

FSE/FSIQ measures at the set receive frequency (ARFCN). If a number of bursts > 1 has been set, only measurement results will be considered at which FSE/FSIQ is able to synchronize. Thus even if the carrier frequency of the slot to be measured changes cyclically in successive frames, only slots with the set slot number at the selected ARFCN will be considered in the measurement.

However, this will considerably slow down the measurement sequence (approx. by the factor 3 compared to a BTS without SFH). This disadvantage can be avoided if a trigger signal is provided for the FSE/FSIQ (triggering not on every frame but only if the selected slot is at the set ARFCN).

Step 3

② Explanation concerning SYNC TO MIDAMBLE:

If option FSE-B7 is built in and the softkey is active, FSE/FSIQ uses the vector signal analyzer to synchronize to the midamble. Power measurement is performed in the scalar spectrum analyzer mode by means of the time reference obtained by the signal demodulation.

Thus an accurate and updated time reference is ensured (even with a jittered trigger pulse). If the softkey is not active, the vector analyzer mode is off and FSE/FSIQ uses the time reference set using ADJUST TRIGGER.

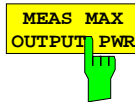
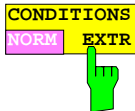
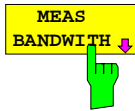

Step 4

Setting the measurement bandwidth

- Press softkey *MEAS BANDWIDTH*. A table indicating the settable bandwidths is displayed on the screen. Selecting STANDARD (default setting) sets the measurement bandwidth specified in the standard.

Or:

Select the measurement bandwidth 3 kHz or 1 MHz using the up/down keys and press the Enter key.

Step 5

- The tolerance range specified in the standards for the measurement is selected with *CONDITIONS* and thus adapted to the measurement conditions.

Default setting is NORM.

Step 6

- The reference level at power control level 0 (static and dynamic) is determined with *MEAS MAX OUTPUT PWR* and checked for the permissible tolerance against the level entered with softkey *OUTPUT POWER* or *POWER CLASS* in menu *BTS TEST SETTINGS*.

Step 7

- The average carrier power is measured at incremented static power control levels (1, 2, 3, 4, 5, 6) and checked for compliance with limit values. To do so the BTS level must be reduced each time by one step in interactive mode and softkey *INCR STAT PWR CTRL* has then to be pressed for the measurement.③

Additional information

Step 7

- ③ Upon completion of the measurement (after pressing seven times *INCR STAT PWR CTRL* and corresponding previous level reduction of BTS) a results table similar to the one below is displayed:



No		CTRL LVL	NORM PWR	MEAS PWR	LIMIT PWR	MEAS DELTA	LIMIT DELTA	STATUS
		S D	dBm	dBm	min.. max dBm	dB	min.. max dB	
E-GSM 900 CARRIER POWER								
ARFCN:			63		Status: PASSED			
Frequency:			947.60000 MHz		Sync: MIDAMBLE RBW: 1 MHz			
Nominal Power(max):			46.0 dBm		Conditions: NORMAL			
Ext Atten:			42.0 dB		No of Bursts: 3			
77	4	12	14.0	14.1	11.0.. 17.0	-2.1	-3.5.. -0.5	PASSED
78	4	13	12.0	12.2	9.0.. 15.0	-1.9	-3.5.. -0.5	PASSED
79	4	14	10.0	10.1	7.0.. 13.0	-2.0	-3.5.. -0.5	PASSED
80	4	15	8.0	8.1	5.0.. 11.0	-2.0	-3.5.. -0.5	PASSED
81	5	0	36.0	36.1	33.0.. 39.0	-2.0	-3.0.. -1.0	PASSED
82	5	1	34.0	34.3	31.0.. 37.0	-1.9	-3.5.. -0.5	PASSED
83	5	2	32.0	32.3	29.0.. 35.0	-2.0	-3.5.. -0.5	PASSED
84	5	3	30.0	30.2	27.0.. 33.0	-2.0	-3.5.. -0.5	PASSED
85	5	4	28.0	28.2	25.0.. 31.0	-2.0	-3.5.. -0.5	PASSED
86	5	5	26.0	26.3	23.0.. 29.0	-1.9	-3.5.. -0.5	PASSED
87	5	6	24.0	24.2	21.0.. 27.0	-2.0	-3.5.. -0.5	PASSED
88	5	7	22.0	22.3	19.0.. 25.0	-1.9	-3.5.. -0.5	PASSED
89	5	8	20.0	20.2	17.0.. 23.0	-2.1	-3.5.. -0.5	PASSED
90	5	9	18.0	18.2	15.0.. 21.0	-2.0	-3.5.. -0.5	PASSED
91	5	10	16.0	16.3	13.0.. 19.0	-1.9	-3.5.. -0.5	PASSED
92	5	11	14.0	14.1	11.0.. 17.0	-2.1	-3.5.. -0.5	PASSED
93	5	12	12.0	12.2	9.0.. 15.0	-1.9	-3.5.. -0.5	PASSED
94	5	13	10.0	10.1	7.0.. 13.0	-2.0	-3.5.. -0.5	PASSED
95	5	14	8.0	8.1	5.0.. 11.0	-2.0	-3.5.. -0.5	PASSED
96	5	15	6.0	6.2	3.0.. 9.0	-1.9	-3.5.. -0.5	PASSED
97	6	0	34.0	34.3	31.0.. 37.0	-1.9	-3.0.. -1.0	PASSED
98	6	1	32.0	32.3	29.0.. 35.0	-2.0	-3.5.. -0.5	PASSED
99	6	2	30.0	30.2	27.0.. 33.0	-2.0	-3.5.. -0.5	PASSED
100	6	3	28.0	28.2	25.0.. 31.0	-2.0	-3.5.. -0.5	PASSED
101	6	4	26.0	26.3	23.0.. 29.0	-1.9	-3.5.. -0.5	PASSED

EXT

Date: 31.AUG.1999 13:05:49

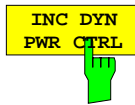

Step 8

- In interactive mode, set the BTS accordingly for the measurements at incremented dynamic power control levels (at a specific static power control level) and press softkey *INC DYN PWR CTRL* fifteen times. ④. After this has been done for static power control level 6, the display is switched from split-screen to full-screen output of the table.
- The table can be scrolled using the spinwheel or keys \uparrow and \downarrow .

or

Step 9

With the previous procedure many power control levels have to be gone through even if only one power control level is to be measured.

If single power control levels are to be measured, proceed as follows:

- Switch softkey *SGL MEAS* to *ON*.
- Select the power control levels to be measured using softkeys *STATIC PWR CTRL LEVEL* and *DYNAM PWR CTRL LEVEL*.
- Start the power measurement of this power control level using softkey *MEAS SGL PWR LEVEL*.

The results obtained can be cleared from the table using softkey *CLEAR SGL RESULT TAB*.

The entries to be examined can be selected with the cursor keys and the spinwheel.

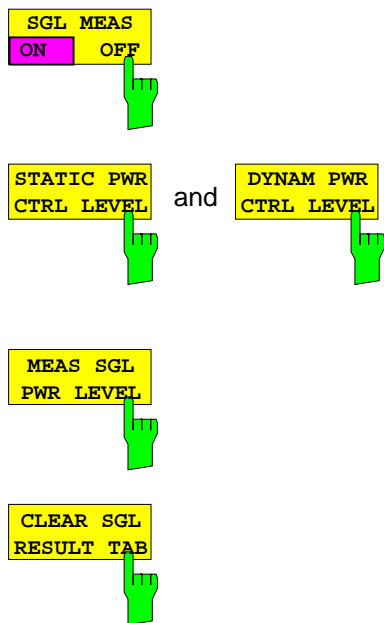

Additional information

Step 8

- ④ An example of the table is given below in which the static power control level has been incremented once (to 1), then all dynamic power control levels (to 15) and again the static power control level (to 6) have been incremented.



P-GSM 900 II CARRIER POWER (INDIVIDUAL)										
No	Ctrl Lvl	ABS POWER	ARFCN	FREQUENCY (Hz)	COND	EXT ATTEN	RBW kHz	BURST COUNT	MEAS POWER	Status
	S D	dBm				dB			dBm	
1	5 0	10.00	1	935200000	NORM	20.00	1000	1	9.48	PASSED
2	5 1	8.00	1	935200000	NORM	20.00	1000	1	7.47	PASSED
3	5 2	6.00	1	935200000	NORM	20.00	1000	1	5.67	PASSED
4	5 3	4.00	1	935200000	NORM	20.00	1000	1	2.60	PASSED
5	5 4	2.00	1	935200000	NORM	20.00	1000	1	-0.48	PASSED
6	5 5	0.00	1	935200000	NORM	20.00	1000	1	-3.52	>FAILED

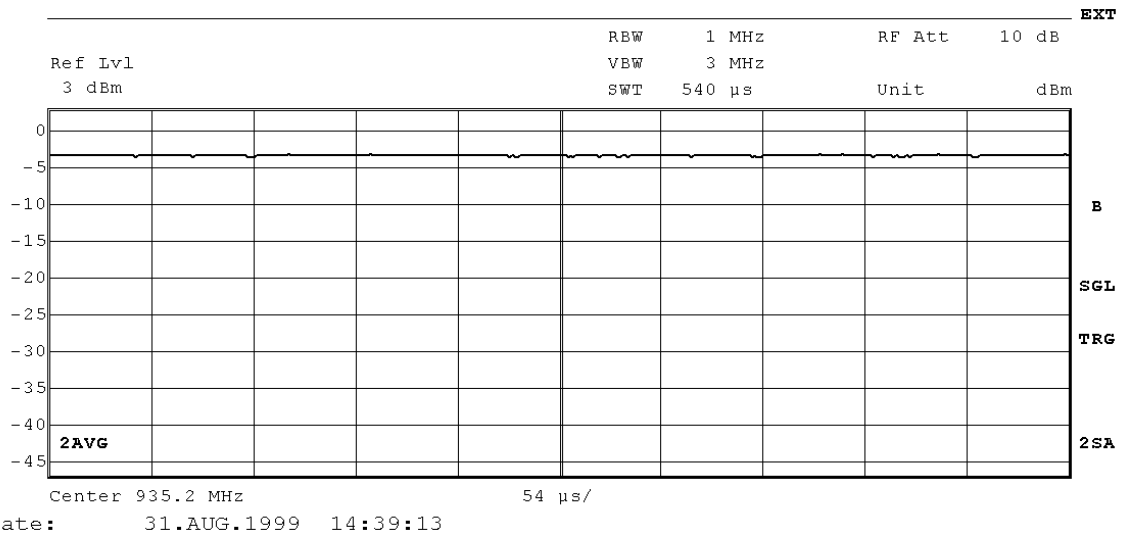

Example: Measurement of the dynamic power control level for static power level 1. The dynamic power control level can be incremented for all static power control levels or only for the required ones. The measurement sequence is completed when the *INC STAT PWR CTRL* softkey is actuated again at static power control level 6 or when *INC STAT PWR CTRL* is actuated again at static power control level 6 and dynamic power control level 15.

1.5 Measuring the Carrier Power versus Time ① ②

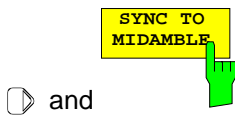
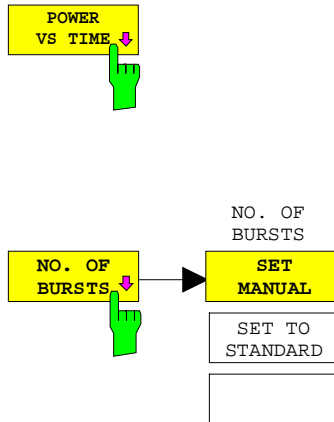

Step 1

- Press softkey *POWER VS TIME*.

Step 2

- Press softkey *NO. OF BURSTS* and set the number of bursts to be measured.

The number of bursts defined in the selected standard is set with SET TO STANDARD (1 for all standards).

Step 3

Possible only if option FSE-B7 is installed

- Activate softkey *SYNC TO MIDAMBLE* and set synchronization to the burst midamble if the burst to be measured contains a midamble and a bit-accurate time reference is required.
- Switch off *SYNC TO MIDAMBLE* for bursts without midamble or if maximum measurement speed is required. ③

Additional information

① BTS setting:

A single timeslot should be active on the transceiver (TRX) to be measured, all other timeslots of the TDMA frame should be set to IDLE.

The measurement can also be performed if the BTS is in the SFH mode if option FSE-B7 is installed and *SYNC TO MIDAMBLE* is active in FSE/FSIQ.

To accelerate the measurement, switch off SFH on the BTS.

② Explanation concerning SYNC TO MIDAMBLE:

If option FSE-B7 is built in and the softkey is active, FSE/FSIQ uses the vector signal analyzer to synchronize to the midamble. Power measurement is performed in the scalar spectrum analyzer mode by means of the time reference obtained by the signal demodulation.

Thus an accurate and updated time reference is ensured (even with a jittered trigger pulse). If the softkey is not active, the vector analyzer mode is off and FSE/FSIQ uses the time reference set using ADJUST TRIGGER.

Step 3

- ③ FSE/FSIQ measures at the set receive frequency (ARFCN). If a number of bursts > 1 has been set, only measurement results will be considered at which FSE/FSIQ is able to synchronize (only if softkey *SYNC TO MIDAMBLE* is activated). Thus even if the carrier frequency of the slot to be measured changes cyclically in successive frames, only slots with the set slot number at the selected ARFCN will be considered in the measurement.

However, this will considerably slow down the measurement sequence (approx. by the factor 3 compared to SFH). This disadvantage can be avoided if a trigger signal is provided for the FSE/FSIQ (triggering not on every frame but only if the selected slot is at the set ARFCN). In this case, the measurement can be performed at slow frequency hopping without synchronization to the midamble.

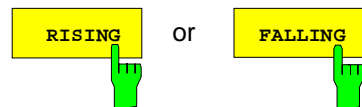
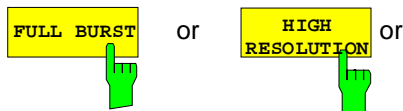
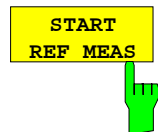
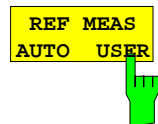
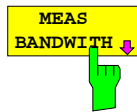

Step 4

Setting the measurement bandwidth

- Press softkey *MEAS BANDWIDTH*. A table indicating the settable bandwidths is displayed on the screen. Selecting *STANDARD* (default setting) sets the measurement bandwidth specified in the standard.

Or:

- Select the measurement bandwidth 3 kHz or 1 MHz using the up/down keys and press the Enter key.

Step 5

REF MEAS AUTO / USER permits to select if a preview is to be performed prior to each measurement for the correct level adjustment of FSE/FSIQ or if the preview is to be started exclusively by the user using *START REF MEAS*. Default setting is *REF MEAS AUTO*.

Step 6

- Select the resolution for the display of bursts: ④
 - *FULL BURST*: The complete burst is displayed
 - *HIGH RESOLUTION*: The 147 useful bits are displayed with 1 dB level resolution.
 - *RISING*: Display of the rising burst edge with high time resolution.
 - *FALLING*: Display of the falling burst edge with high time resolution.
 - *FALLING EDGE*: Darstellung der fallenden Burstflanke mit hoher Zeitauflösung.

Additional information

Step 6

④  Max/Ref Lvl RBW 1 MHz RF Att 20 dB
 34 dBm VBW 1 MHz Mixer -20 dBm
 21.7 dBm SWT 800 μs Unit dBm

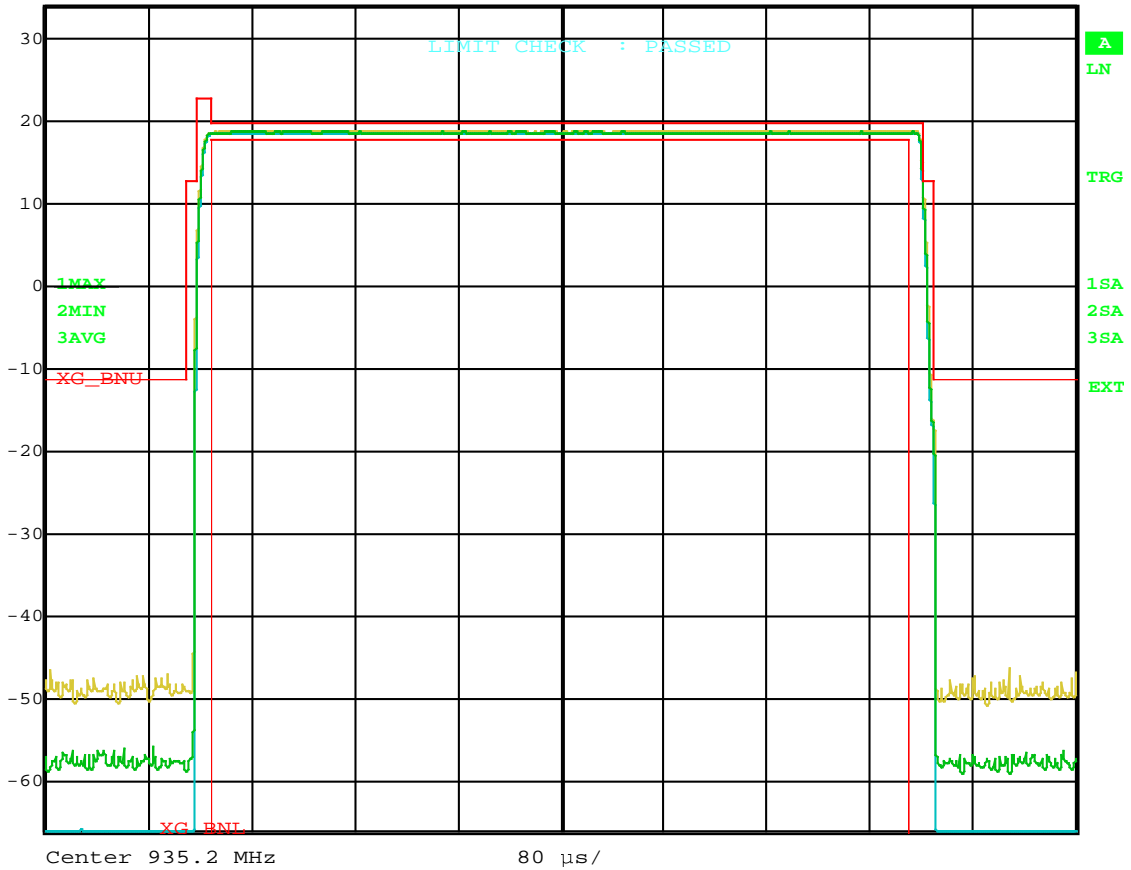

Date: 6.JUL.1999 13:11:02

Fig. 1-4 Display of burst for FULL BURST

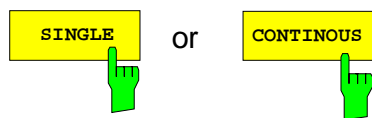
**Step 7**

- Press softkey *SINGLE* to start a single measurement sequence or *CONTINUOUS* for a continuous measurement sequence. The bursts are displayed according to the selection made at step 4.

This page is left intentionally empty to ensure that the user's notes are always opposite to the additional information.

1.6 Measuring the Spectrum due to Modulation ①

Note: The test setup is described in section 1.1.

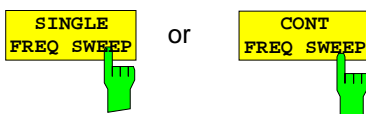
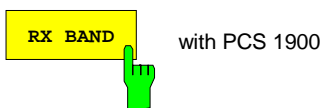
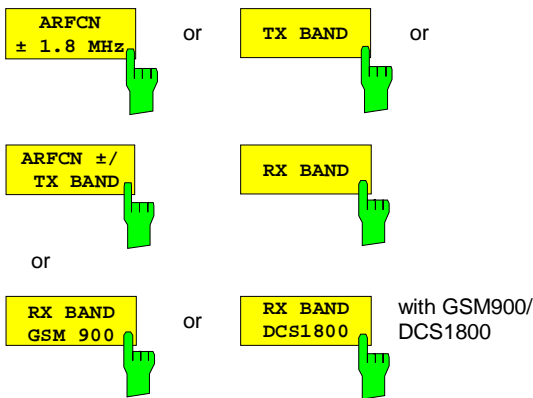
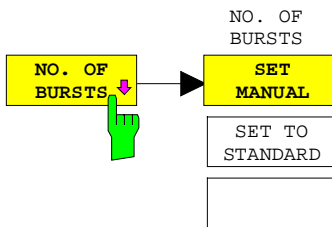
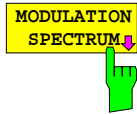

Step 1

- Press softkey **MODULATION SPECTRUM**. ②

Step 2

- Press softkey **NO. OF BURSTS** and determine the number of bursts to be measured.

The number of bursts defined in the selected standard is set with **SET TO STANDARD**.

This depends on the selected frequency band. ③

Step 3

- Select the frequency range for the measurement: **ARFCN ± 1.8 MHz**, **TX-BAND**, **RX-BAND** or combined band **ARFCN ± 1.8 MHz/TX BAND**. (RX band possible only with GSM/DCS phase 1).

Caution: The test setup is changed for measurement in RX band.

Step 4

- Start the measurement in the frequency range (spectral display) with **SINGLE FREQ SWEEP** (single sweep) or **CONT FREQ SWEEP** (continuous sweep). ③

Additional information

① **BTS setting:**

Set all timeslots of a TDMA frame to the same power and modulate them with pseudo-random data. (Exception: timeslot 0 may also be modulated with normal BCCH data). SFH (slow frequency hopping) should be switched off.

Step 1

- ② The measurement is performed as prescribed by excluding the midamble of 50 to 90 % of the burst. (Precondition: correct setting of Adjust Trigger in the SETTINGS menu; step 1 ②). If required, the setting can be checked and corrected using the *ADJUST TRIGGER* softkey. The measurement can be performed as a spectral display measurement or, depending on the standard, as a zero-span measurement with subsequent output of tabulated numerical results.

Step 4

- ③ A spectral display is not possible in the combined band *ARFCN ± 1.8 MHz/TX-BAND* (softkeys *SINGLE FREQ SWEEP*, *CONT FREQ SWEEP* cannot be operated).

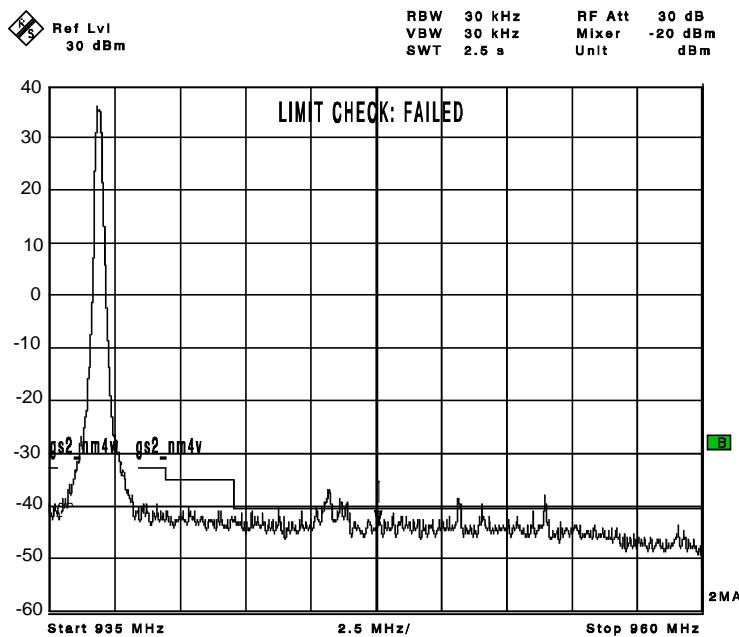
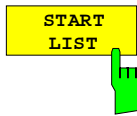

Fig. 1-5 Spectral display (*SINGLE FREQ SWEEP*) in the range *ARFCN ± 1.8 MHz*

**Step 5**

- Start the strictly standard-conforming zero-span measurement with *START LIST*: ④

Additional information

Step 5

④



P-GSM 900 II		MODULATION SPECTRUM LIST			ARFCN ±1.8MHz	
ARFCN:		1			Status: FAILED	
Frequency:		935.20000 MHz				
Carrier Power:		20.0 dBm			Ext Atten: 20.0 dB	
Ref Pwr (RBW 30 kHz)		10.88 dBm			No of Bursts: 1	
No.:	Offset Freq.	+Offset	-Offset	Limit	Status	
1 2	100 kHz	-9.5 dB	-7.1 dB	0.5 dB	PASSED	
	200 kHz	-35.4 dB	-37.6 dB	-30.0 dB	PASSED	
	250 kHz	-39.6 dB	-36.8 dB	-33.0 dB	PASSED	
	400 kHz	-62.4 dB	-56.0 dB *	-60.0 dB	>FAILED<	
	600 kHz	-58.4 dB *	-61.0 dB	-60.0 dB	EXC	
	800 kHz	-61.1 dB	-65.6 dB	-60.0 dB	PASSED	
	1000 kHz	-65.9 dB	-67.5 dB	-60.0 dB	PASSED	
	1200 kHz	-73.4 dB	-74.0 dB	-63.0 dB	PASSED	
	1400 kHz	-82.6 dB	-82.4 dB	-63.0 dB	PASSED	
	1600 kHz	-85.1 dB	-84.2 dB	-63.0 dB	PASSED	
1800 kHz	-85.0 dB	-84.3 dB	-63.0 dB	PASSED		

EXT

Fig. 1-6 Result display for zero-span measurement (START LIST) in the range ARFCN ±1.8 MHz

1.7 Measurement of Spectrum due to Transients ①

Note: The test setup is described in section 1.1.

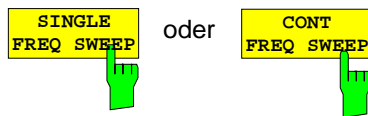
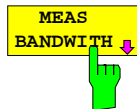
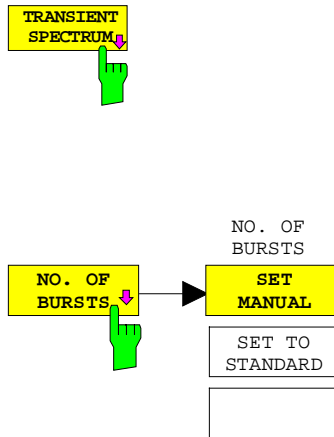

or

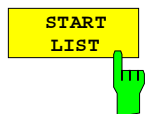

Step 1

- Press softkey **TRANSIENT SPECTRUM**.

Step 2

- Press softkey **NO. OF BURSTS** and set the number of bursts to be measured.

The number of bursts defined in the selected standard is set with **SET TO STANDARD**.

Default setting is **NO OF BURSTS =1**

Step 3

- Set the measurement bandwidth with **MEAS BANDWIDTH**. A table indicating the settable bandwidths is displayed on the screen. Selecting **STANDARD** sets the measurement bandwidth specified in the standard.

Selection is performed by means of the up/down keys and the Enter key.

Step 4

- ② ➤ Press softkey **SINGLE FREQ SWEEP** or **CONT FREQ SWEEP**. ③ The measurement is started in the spectral range.

Alternatively:

- Press softkey **START LIST**. A zero-span measurement is started ④.

Additional information

① **BTS setting:**

The measurement can be performed with or without SFH (slow frequency hopping) as required. The FSE/FSIQ measurement routine is able to handle the two cases. According to the standards, the slots of a TDMA frame can be measured at two different levels depending on whether the BTS supports dynamic power control or not.

Step 4

② The measurement can be performed as an overview measurement in the frequency range with spectrum display or as a zero span measurement and subsequent output of tabulated numerical results depending on the standard. In both cases a maximum offset frequency of ± 1.8 MHz is used for the measurement.

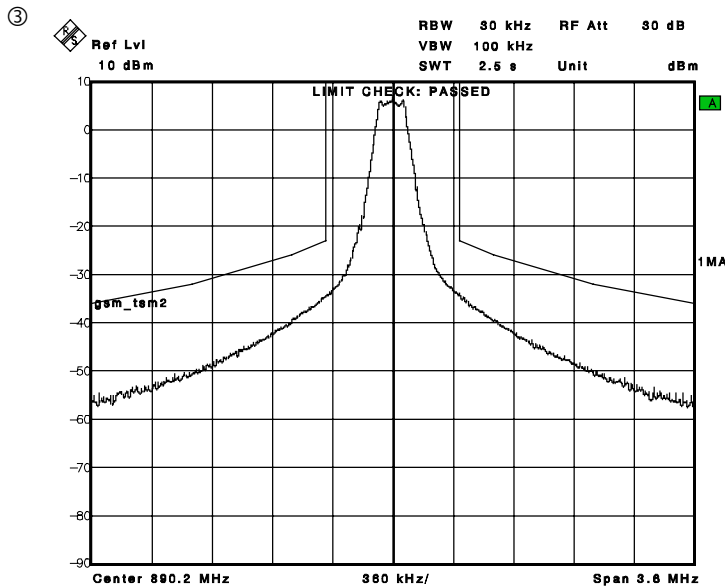

Fig. 1-7 Display of spectrum due to transients of a GSM base station (measurement in frequency range). Limit lines are inserted, the pass/fail info is displayed.

④

P-GSM 900 II		TRANSIENT SPECTRUM LIST			
ARFCN:	1	Status: PASSED			
Frequency:	935.20000 MHz				
Carrier Power:	20.0 dBm	Ext Atten:	20.0 dB		
Ref Pwr (REBW 300 kHz)	18.62 dBm	No of Bursts:	1		
No.:	Offset Freq.	+Offset	-Offset	Limit	Status
	400 kHz	-37.7 dBm	-51.4 dBm	-36.0 dBm	PASSED
	600 kHz	-52.3 dBm	-53.0 dBm	-36.0 dBm	PASSED
	1200 kHz	-57.4 dBm	-62.9 dBm	-36.0 dBm	PASSED
	1800 kHz	-66.1 dBm	-64.5 dBm	-36.0 dBm	PASSED

Fig. 1-8 Display of transient spectrum list (zero-span measurement). Results, limits and pass/fail information for the offset frequencies prescribed by the standards and a general pass/fail information are also displayed.

1.8 Measurement of Spurious ①

Note: The test setup is described in section 1.1.

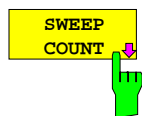
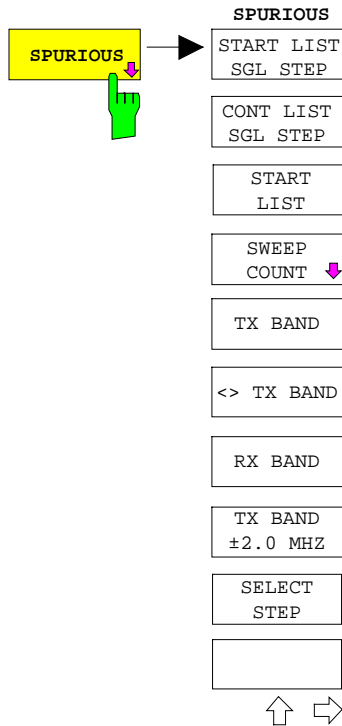

Step 1

➤ Press softkey *SPURIOUS*.

Step 2

In the submenu which can be opened by means of softkey *SWEEP COUNT* set the number of sweeps for averaging in the RX band or the number of sweeps for determining the peak values within and outside the TX band. The SWEEP number required by the standard can be set with SET TO STANDARD in the submenu.

Press  to return to the SETTINGS menu.

Additional information① **BTS setting:**

The BTS is to be configured depending on the selected frequency band (TX, <>TX or RX band):

GSM900, DCS1800 phase 1:

TX band and <>TX band

If the BTS supports SFH (slow frequency hopping), SFH should be selected (change between B, M and T channel). Switch every second timeslot to full power.

RX band:

Switch all slots to full power.

GSM900/DCS18000 phase 2:

The BTS is to be configured depending on the selected frequency band (TX, <>TX or RX band):

TX band:

Switch on a TRX with maximum power on all slots.

Switch off SFH.

<>TX band:

Switch every second timeslot to full power. If the BTS supports SFH, SFH should be selected.

RX-Band:

Switch all timeslots of the BTS to full power. Switch off SFH (slow frequency hopping).

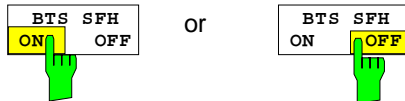
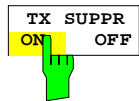
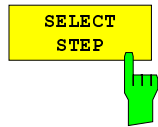
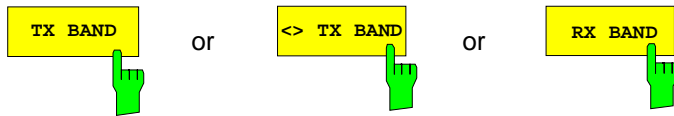

Step 3

- Determine the measurement range with *TX BAND*, *<> TX BAND* (outside TX and RX Band) or *RX BAND*. The test setup has to be modified depending on the frequency band used (see section 1.1.3).

Other subranges can be selected or excluded in the used band using softkey *SELECT STEP*.

Measurement in *<>TX Band*:

- For BTSs with an output power of approx. > 35 dBm, the carrier signal(s) must be suppressed by at least 25 dB to give FSE/FSIQ sufficient sensitivity for a large measurement bandwidth (≥ 300 kHz) and also to prevent harmonics generated by FSE/FSIQ from being measured. The suppression can be performed using a bandstop filter or a highpass filter if harmonics are measured. In this case *TX SUPPR ON* has to be activated in addition. FSE then increases its sensitivity by 20 dB (reference level reduced by 20 dB).

Step 4

- If the BTS is to be measured in the SFH mode (slow frequency hopping), switch *BTS SHF* to *ON*. (Condition: ARFCN = M channel). ②

Step 5

- Select between two settings for the analyzer sweep time using *SWEPTIME*. The sweep time (very long in some cases) required by the selected standard can be set with *STD*. The minimum sweep time of the analyzer is set with *AUTO*.

Additional information**Step 4**

- ② The measurement time is extended as required (by the factor 3 compared to SFH OFF). For measurements in the TX band the B and T channels are skipped in addition to the ARFCN channel.

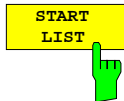
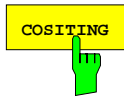

Alternativ:

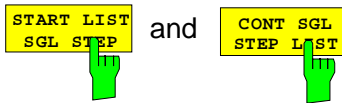

Step 6

- If a cositing BTS is to be measured for GSM900/DCS1800 phase 2, activate the softkey *COSITING* ③.

Step 7

- If a complete measurement is to be performed in the selected TX, <>TX or RX band, press softkey *START LIST*.

Alternative:

- For a ***step-by-step*** measurement of the individual frequency bands (TX and <> TX band), press softkeys *START LIST* *SGL STEP* and *CONT SGL LIST*:

After the measurement has been completed, a tabulated overview of results with limits and pass/fail information is displayed. ④

Additional information

Step 6

- ③ A cositing BTS can send and receive in the GSM band and the DCS1800 band.

If measurements are performed in the RX band of the system used (defined under SETTINGS), the RX band of the other system is also measured.

Step 7

- ④

P-GSM 900 II		SPURIOUS LIST			TX Band
ARFCN: 1		Status: FAILED			
Frequency: 935.20000 MHz		Ext Atten: 20.0 dB			
Carrier Power: 20.0 dBm					
No.	Frequency	Level	Limit	Status	
	937.00000 MHz --- 941.20000 MHz	-60.3 dBm	-36 dBm	PASSED	
	941.20000 MHz --- 960.00000 MHz	-19.1 dBm	-36 dBm	>FAILED<	
1	950.09138 MHz	-19.1 dBm	-36 dBm	>FAILED<	
2	949.82766 MHz	-20.2 dBm	-36 dBm	>FAILED<	
3	949.18717 MHz	-23.5 dBm	-36 dBm	>FAILED<	
4	948.54669 MHz	-28.0 dBm	-36 dBm	>FAILED<	
5	948.81042 MHz	-28.7 dBm	-36 dBm	>FAILED<	
6	947.75551 MHz	-30.6 dBm	-36 dBm	>FAILED<	

EXT

Fig. 1-9 Example of a spurious list

In addition to the general information at the top of the table including the general PASS/FAIL information, all frequency ranges, the maximum level measured in the range and the applicable range limit plus status information are listed.

A frequency range is defined by an identical RBW/VBW setting of the FSE/FSIQ and the same LIMIT.

If the margin or the limit of a frequency range is exceeded, spurious frequencies with levels are listed in addition (with numbers).

2 General Information on Option FSE-K11

This application allows the following measurements to be performed on GSM900, DCS1800 or PCS1900 base stations in line with standards (GSM 11.20, GSM 11.20-DCS, GSM11.21 and J-STD-007 Air Interface) in a very convenient way:

- PFE Phase/frequency error
- CPW Carrier power
- PVT Power versus time
- MOD Spectrum due to modulation
- TRA Spectrum due to transients
- SPU Spurious emissions

This chapter gives basic information on the sequence of operations, settings and messages of the instrument. Details on the individual measurements will be found in chapter 3. The information given under "General Remarks" is not needed for normal test operation. It is intended to provide a better understanding of instrument settings and operations.

Cold Start	A complete reset to default values is made.
Warm Start	The previous status is assumed to a large extent. This applies to all parameter values and to the selected measurement. The settings specific to the type of measurement and band are made. The default measurement type (LIST/SINGLE) is selected. The result history is cleared, so the results of previous measurements are no longer available after a warm start !
Opening FSE-K11	<p><u>Re-opening FSE-K11</u> Action: Exiting FSE-K11 via the mode menu, changing to non-FSE-K11 mode, re-opening FSE-K11. The response is the same as with a warm start except that the result history remains stored.</p> <p><u>Changing between FSE-K10 and FSE-K11</u> Action: Switching between FSE-K10 and FSE-K11 via the mode menu. The response is the same as with a cold start.</p>
Changing within FSE-K11	<p><u>Changing the standard</u> Each change of standard causes a complete reset to the default values valid for the standard in question. The reset is performed without any warning to the user.</p> <p><u>Changing the phase</u> Changes of phase are performed with as few modifications as possible. If problems due to incompatibility of output data are detected during a phase change, the responsible group of parameters is reset to default values. In such case a temporary message is output informing the user of the modifications made. With IEC/IEEE-bus control, the response is the same as with a change of standard !</p> <p>Possible problems and resulting actions:</p> <p>Change of frequency group: <i>No problems are to be expected.</i></p>

The following overview lists the types of FSE-K11 measurement in accordance with the above description:

Measurement	Mode	Pre-measurement		Sequence data	Remarks
		without	with		
KXX PFE	XX		---	
KXX CPW	XX		XX	
KXX CPI	XX		XX	
KXX PVT		XX	---	Also without pre-measurement, user-selectable; normally with 2 pre-measurements
KXX MOD RX	SINGLE, CONT	XX		---	
KXX MOD RX	LIST	XX		XX	
KXX MOD Tx, ARFCN ± 1.8 MHz	SINGLE, CONT		XX	---	Bandwidth correction necessary (see below)
KXX MOD Tx, ARFCN ± 1.8 MHz	LIST		XX	XX	Bandwidth correction necessary (see below)
KXX SPU xxx	XX		XX	

Measurements of the spectrum due to modulation require a reference value for the limit lines to be measured at 30 kHz bandwidth. To evaluate the actual carrier power (ie the signal power measured at infinite bandwidth) a bandwidth-dependent correction value is added to the pre-measured value: this is at present 8 dB for 30 kHz (following GSM 05.50). The corrected value is also used for selecting the limit lines.

The following diagram shows the sequence of operations of a measurement performed with FSE-K11. This diagram applies to all measurements except for the CPW/CPI measurement, which is shown in a separate diagram (for sequence of operations see also chapter 3).

The measurement type is selected in the main menu. Prior to this, general settings are performed if necessary, with most parameters also being accessible from the side menus of the measurements. On opening a measurement menu, general settings specific to the measurement in question are made. These settings are made only once. In the basic menu for a given measurement, the results of the measurement last performed (table) are displayed in the full-screen mode (MOD, TRA, SPU, CPW) on opening the menu. For the CPI, PVT and PFE measurements, on the other hand, the screen settings for the main measurement are activated immediately (for CPI the table cannot be displayed in the full-screen mode). For MOD and SPU the band can be selected. The table contents change depending on the selected band.

The measurement start initiates the (first) pre-measurement. After completion of the pre-measurement, the measured signal level is evaluated. If the pre-measurement is successful, either the second pre-measurement is performed with optimum sensitivity (for PVT) or the main measurement is carried out with level control orientated to the pre-measurement. The result is displayed at the end of the measurement.

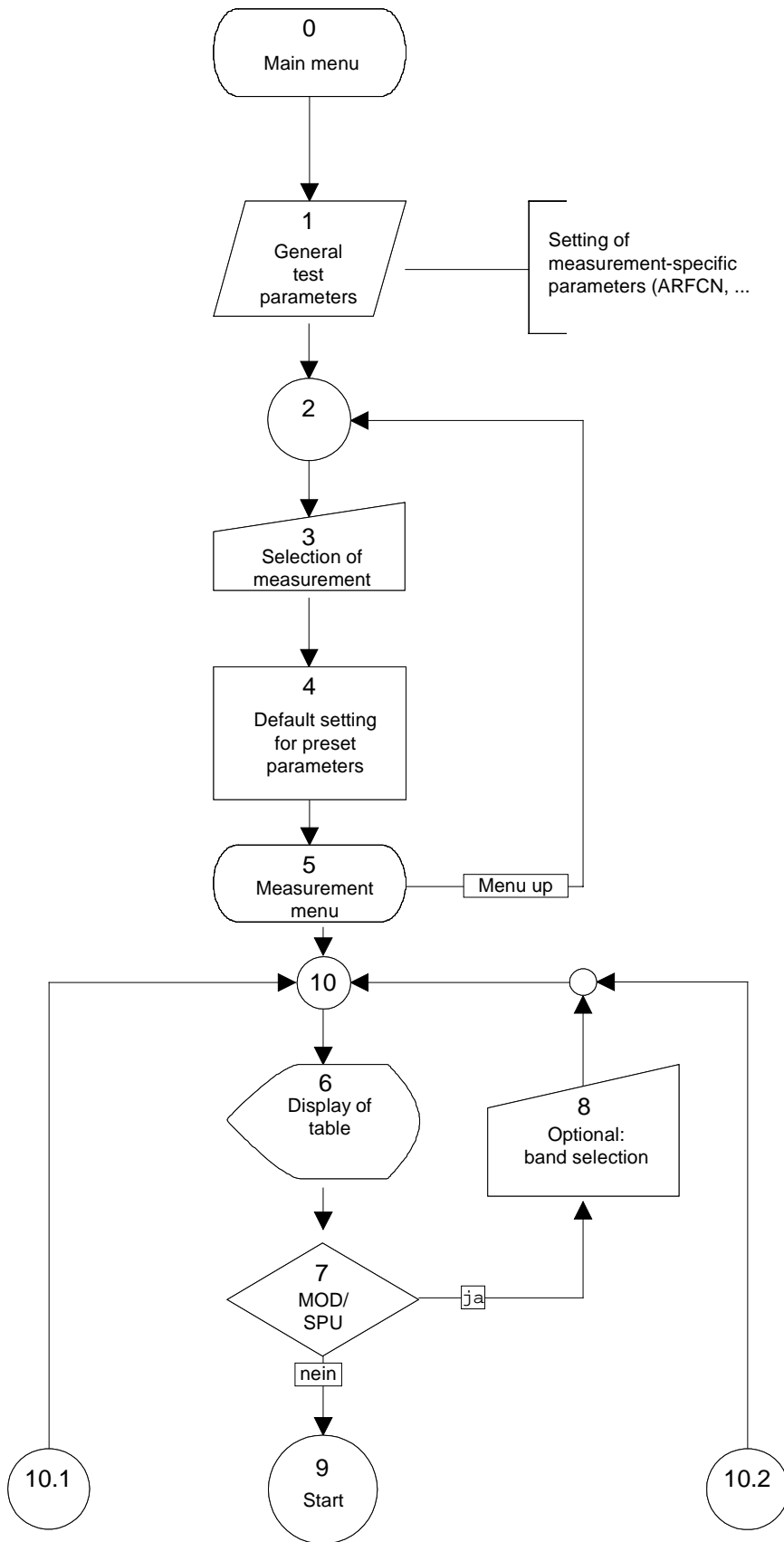

Fig. 2-1 Sequence of operations upon selecting a measurement

Explanation of Legend:

- 0 The main menu of FSE-K11 is called: general settings (SETTINGS) or a measurement can be selected.
- 1 General settings for GSM measurement (ARFCN, attenuation, power, trigger, ...).
- 2 Main menu: one of the FSE-K11 measurements PFE-CPW/CPI-PVT-MOD-TRA-SPU can be selected.
- 3 Selection of measurement type via main menu.
- 4 FSE/FSIQ assumes default setting for the selected measurement.
- 5,6,7,8 In the basic menu for a given measurement, the results of the measurement last performed (table) are displayed in the full-screen mode (MOD, TRA, SPU, CPW) on opening the menu. For the CPI, PVT and PFE measurements, on the other hand, the screen settings for the main measurement are activated immediately (for CPI the table cannot be displayed in the full-screen mode). For MOD and SPU the band can be selected. The table contents change depending on the selected band.

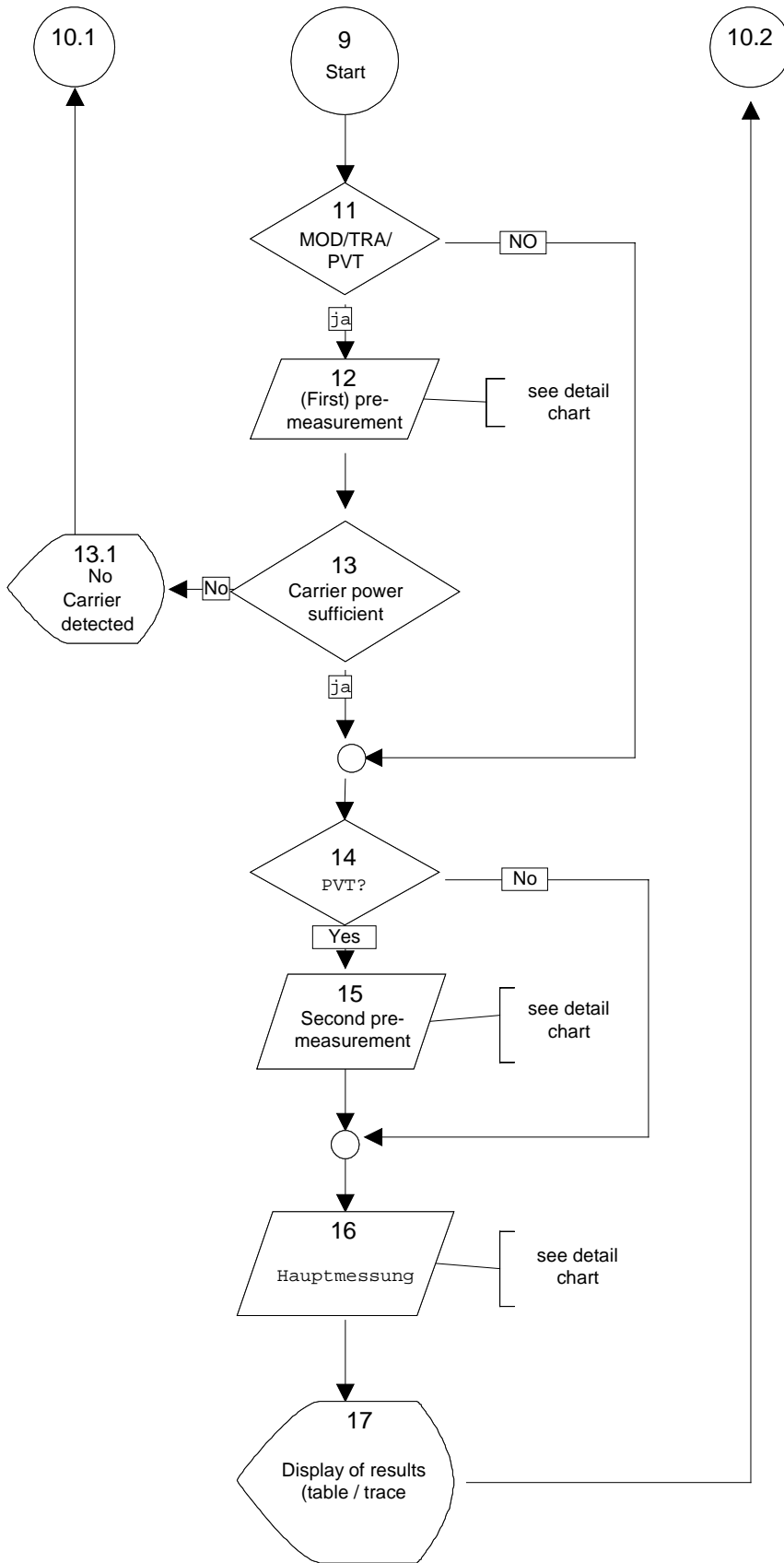

Fig. 2-2 Sequence of operations upon starting a measurement (overview)

Explanation of Legend:

- 9 Start of measurement with 'SINGLE', 'CONTINUOUS' or 'START LIST'.
- 11 For the measurements TRA/PVT and MOD (not RX band), the (first) pre-measurement is performed; for the measurements PFE, CPW/CPI, MOD-Rx and SPU the main measurement is started immediately.
- 12 The sequence of operations of a pre-measurement is presented in detail in a separate diagram (see "General sequence of operations of a measurement").
This sequence chart applies to both pre-measurements and main measurements.
- 13 Sufficient carrier power: the measured signal level (incl. bandwidth correction) must not be more than 20 dB below the signal level to be expected for the settings made.
- 13.1 An error message is output temporarily and the IEC/IEEE status bit set.
- 14, 15 After the first pre-measurement, a second pre-measurement is carried out for PVT (see "Sequence of operations of PVT measurement in detail") to determine the exact reference value.
The second pre-measurement is performed with optimum sensitivity.
- 16 Main measurement with level control orientated to pre-measurement. The sequence of operations is presented in detail in a separate chart (see "General sequence of operations of a measurement").
This sequence chart applies to both pre- and main measurements.
- 17 The result is displayed as a table or a trace.

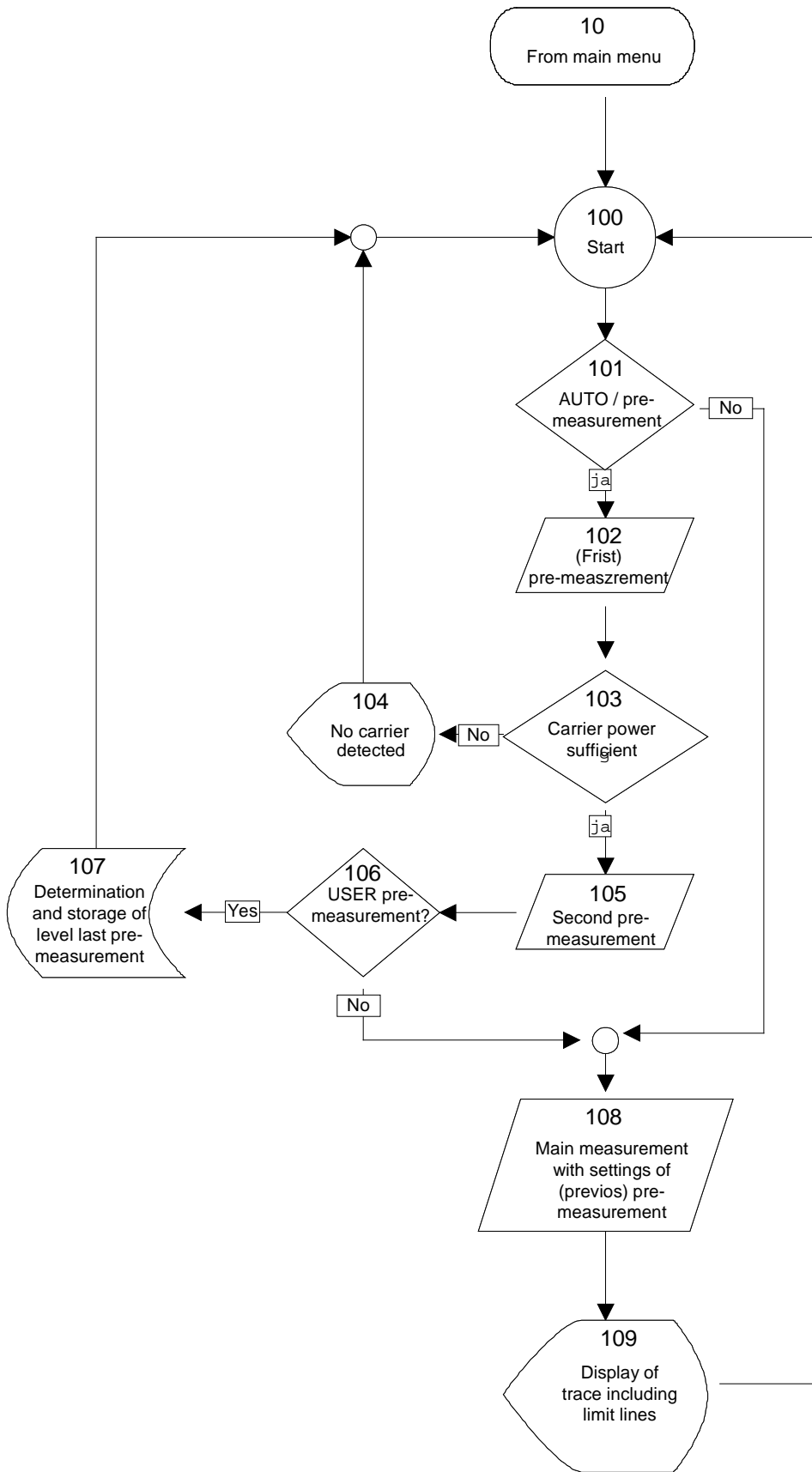

Fig. 2-3 Sequence of operations of PVT measurement in detail

The above chart presents the PVT measurement in detail. The sequence of operations is determined by the setting for the pre-measurement – *REF MEAS AUTO* or *REF MEAS USER*.

With AUTO, the PVT measurement is performed as follows:

1st pre-measurement - 2nd pre-measurement - main measurement.

The settings for the first pre-measurement (with max. 2 measured bursts) are made in accordance with the expected level. The settings for the second pre-measurement are made in accordance with the signal level determined in the first pre-measurement, and level measurement is performed with max. 20 bursts. The signal level determined in the second pre-measurement is used as a reference for the limit lines used in the subsequent main measurement.

Two-stage pre-measurement results in highly accurate level determination even in cases where the signal level is considerably below the expected value since, thanks to the follow-up level control, it is ensured that the measurement is always performed with optimum sensitivity.

With the USER setting, the pre-measurements are skipped, and the level determined in the last pre-measurement is used both for setting the operating point and as a reference for the limit lines. If no level has been determined, the nominal value (expected signal level) is used.

This setting allows fast switching between the various burst views (Rising, Falling, Full, HighRes). Actuating the Start RefMeas key will trigger a sequence of two pre-measurements without any main measurement following.

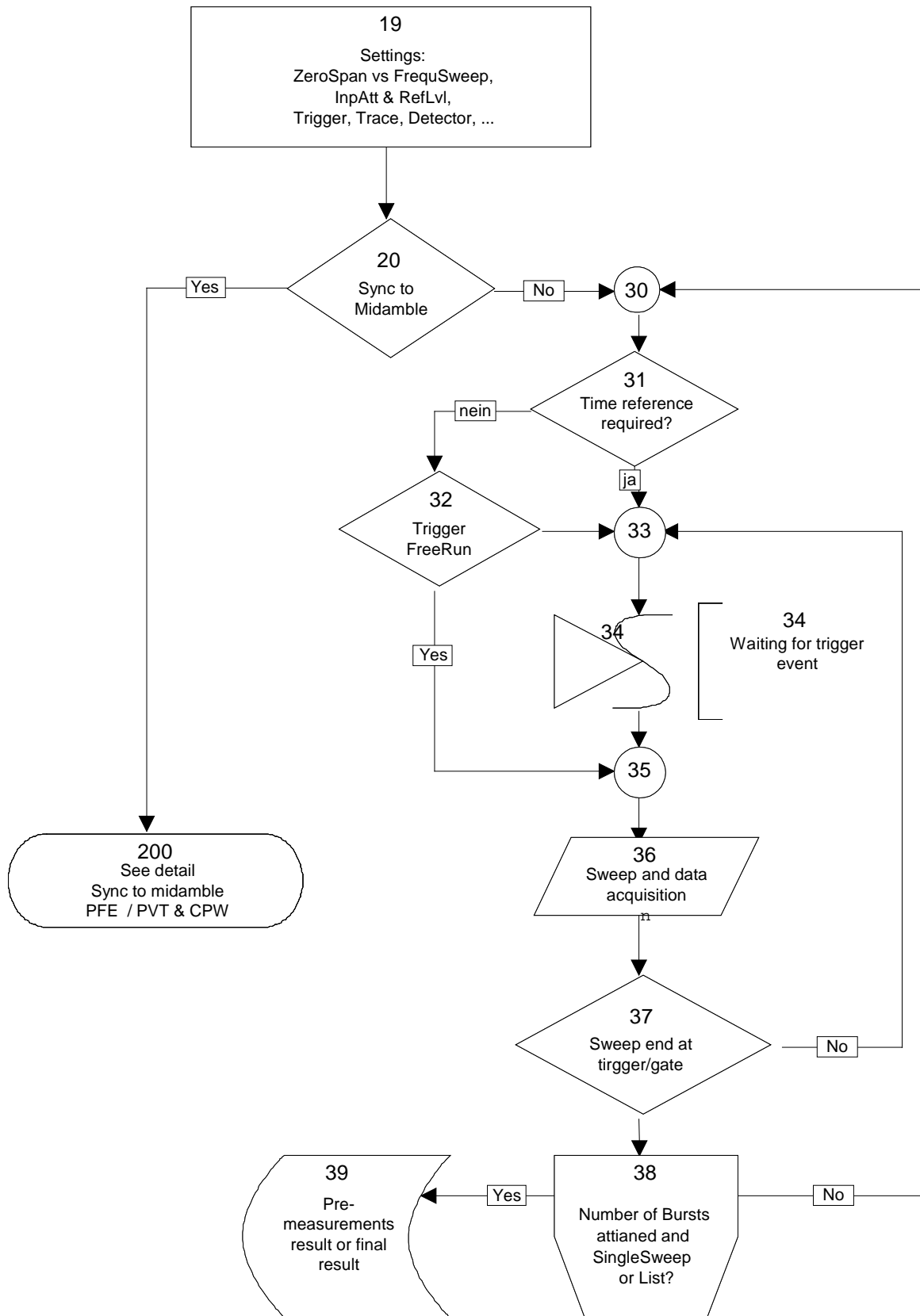

Fig. 2-4 General sequence of operations of a measurement

The sequence of operations is the same for each measurement (the above sequence chart applies to both pre-measurements and main measurements):

- 19 The settings needed for the intended measurement are made.
- 20 Synchronization to midamble is optional for PVT and CPW/CPI and mandatory for PFE.
This choice is possible only if option FSE-B7 is fitted.
- 30-39 Measurement without digital demodulator (ie without option FSE-B7).
- 31,33 All measurements (except transient and spurious) require a time reference.
- 32,33 If FreeRun is not selected, FSE-K11 waits for the (external) trigger event here too.
- 34 FSE-K11 waits for the trigger event, then starts or continues the sweep.
- 35 The sweep is enabled.
- 36 Measured data are collected until the end of the sweep or, with gated sweep, during a specific gate time.
- 37 It is checked if the sweep is terminated.
- 38 It is checked if the number of preset sweeps has been attained AND if the measurement is of the SINGLE or the LIST type.
- 39 The measurement is completed if the preset number of sweeps has been attained and the measurement is of the SINGLE or the LIST type.

If digital demodulation is active, there are some differences concerning trigger logic as compared to the sequence of operations shown in the chart "General sequence of operations of a measurement".
The sequence of operations with digital demodulation active is shown below for PFE and PVT/CPW:

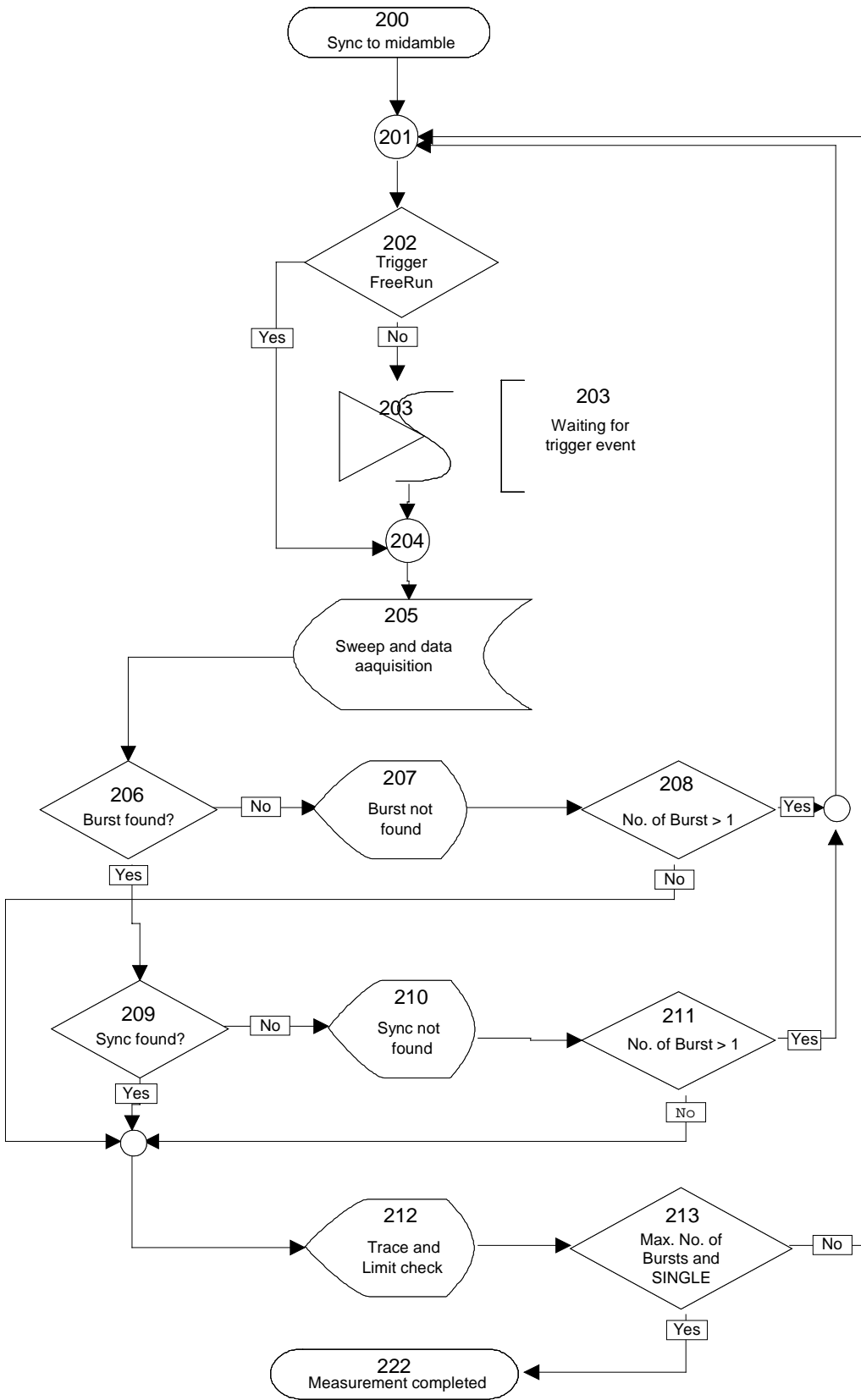

Fig. 2-5 PFE - Sequence of operations of synchronization in detail

PFE – sequence of operations:

- 200-204 Waiting for trigger event or FreeRun (not meaningful !).
- 205 Collection of measured data.
- 206 Search for bursts in a predefined time window (compare settings for result buffer).
- 207,
- 208 In case of an error, a message is output and the IEC/IEEE status bit 'Burst not Found' is set. In the special case of "NofBursts == 1", the error condition is ignored however during further processing.
- 209 Search for sync pattern in the selected burst.
- 210,
- 211 In case of an error, a message is output and the IEC/IEEE status bit 'Sync not Found' is set. In the special case of "NofBursts == 1", however, the error condition is ignored during further processing.
- 212 Evaluation of trace with numerical indication of the measured frequency error and phase error.
- 213 If the predefined number of bursts has been attained and the measurement has been started with 'SINGLE', it ends at this point.

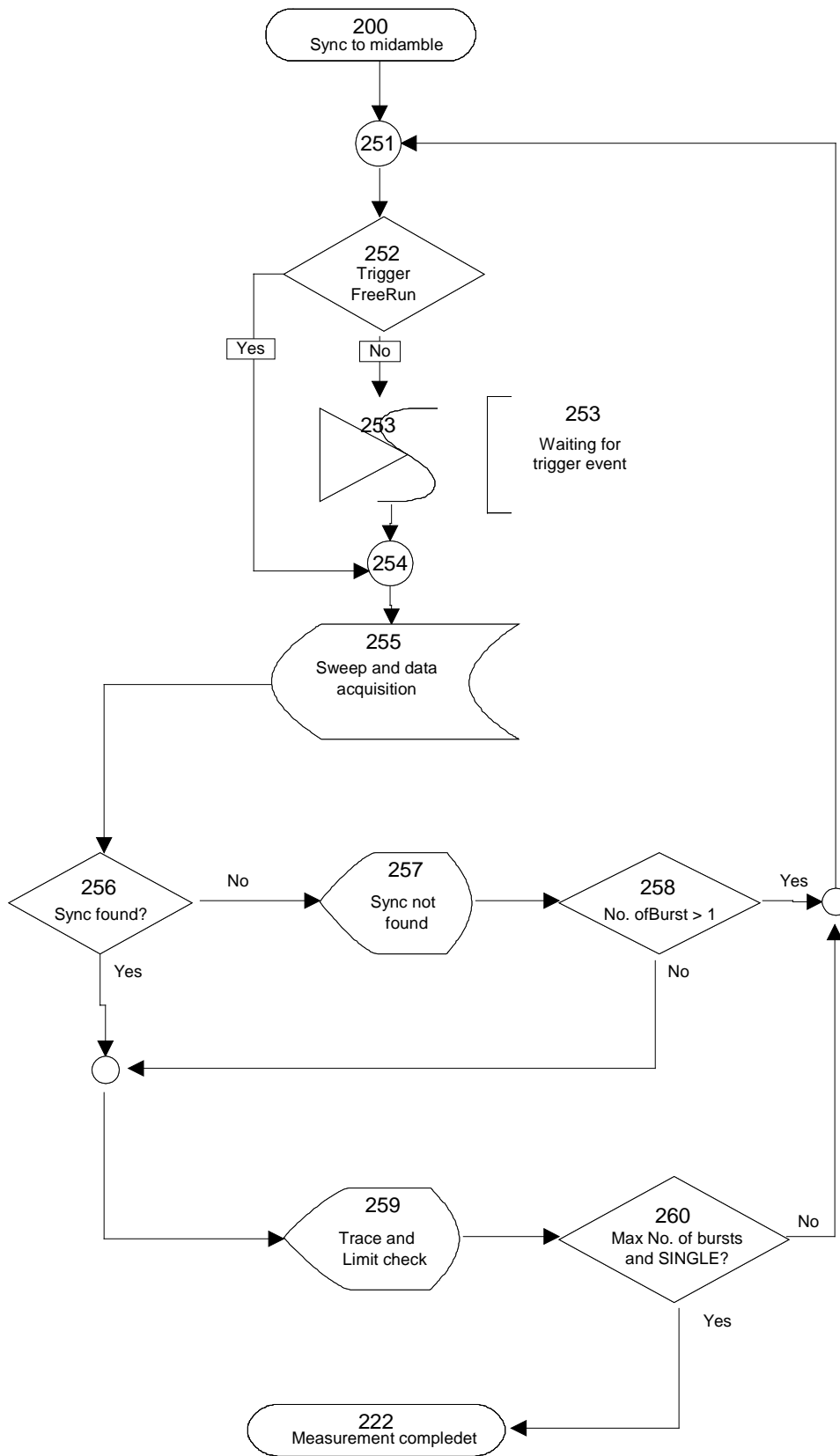

Fig. 2-6 PVT/CPW - sequence of operations of synchronization in detail

PVT/CPW – sequence of operations:

The sequence of operations for PVT/CPW differs from that for PFE in that no burst search is performed. Only the sync pattern (items 256 and 257) is searched within a limited range of the recorded data stream (compare "Settings") to establish a high-precision time reference. In the case of an error, the procedure is the same as for PFE, including the special case of "NofBursts == 1".

- 200-254 Waiting for trigger event or FreeRun (not meaningful!).
- 255 Collection of measured data.
- 256 Search for sync pattern in the selected burst.
- 257,258 In case of an error, a message is output and the IEC/IEEE status bit 'Sync not Found' is set. In the special case of "NofBursts == 1", the error condition is ignored however during further processing.
- 259 Evaluation of trace with limit check.
- 260 If the predefined number of bursts has been attained and the measurement has been started with 'SINGLE', it ends at this point.

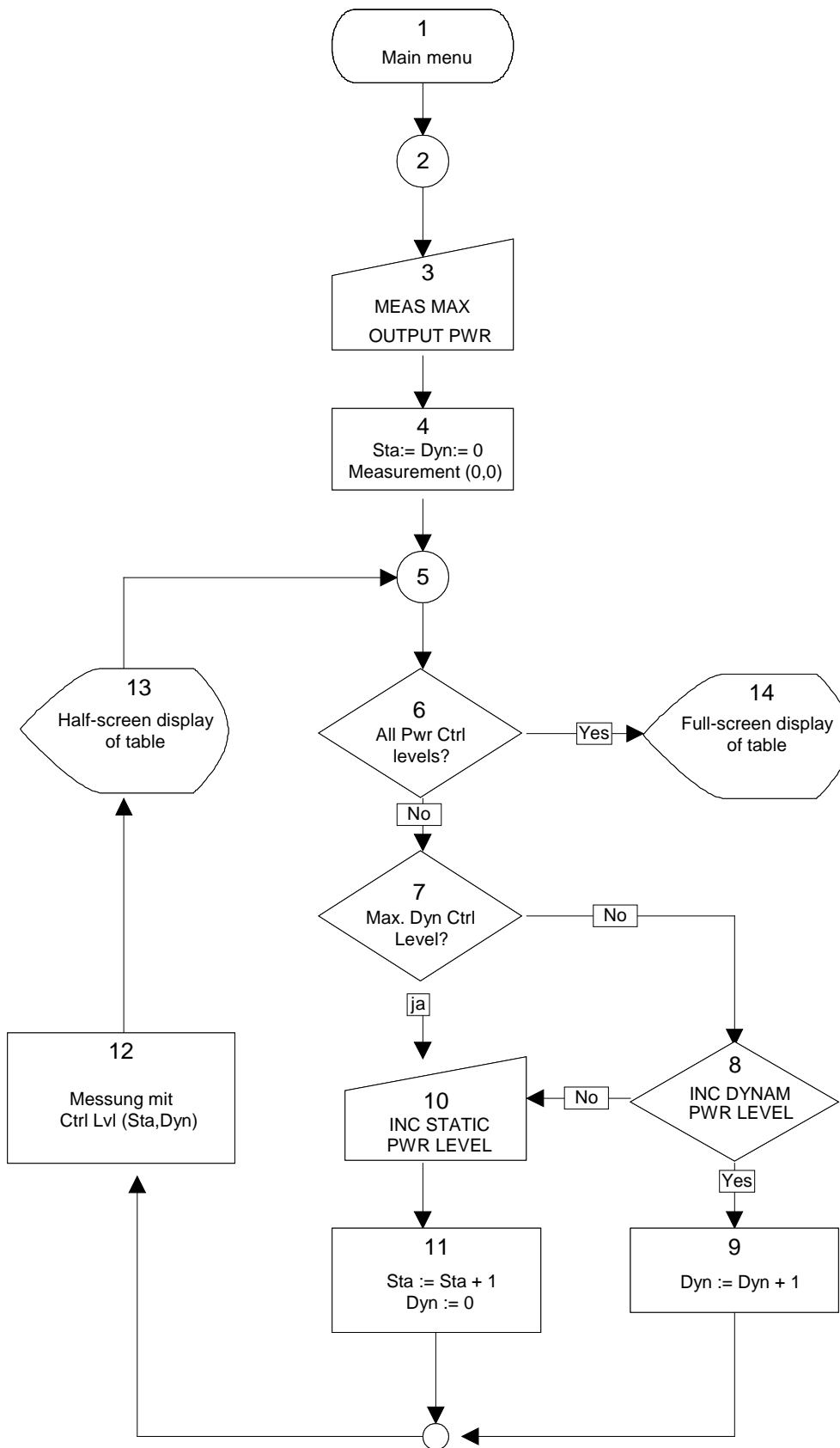

Fig. 2-7 Sequence of operations of CPW measurement in detail

The sequence of operations of a CPW measurement (BTS/K11) is shown above. The measurement is initiated by pressing the 'MEAS MAX OUTPUT PWR' key. Then either the static or the dynamic power control level can be incremented as required. Each incrementation of the static power control level will reset the dynamic power control level to 0 (zero). If the initializing key 'MEAS MAX OUTPUT PWR' is actuated again during the current session, the session is aborted (measurement status: ABORTED). Entries by the user are dependent on the availability of keys 'INC STATIC PWR LEVEL' and 'INC DYNAM PWR LEVEL': if the maximum value of the dynamic power control level is attained, the 'INC DYNAM PWR LEVEL' key is inhibited so that only the static power control level can be increased. If the maximum value is attained here too, pressing the key again causes the session to be terminated and the total result to be displayed on the full screen.

With the 'full-screen table' status, both INC keys are inhibited, and a new session can be started only by pressing the 'MEAS MAX OUTPUT PWR' key.

Unlike the CPW measurement, the CPI measurement allows any single carrier-power measurements. In contrast to all other measurements performed with FSE-K11, single CPI measurements are not related to one another. There is no total result for the session. The CPI menu can be exited and activated any time without this having any effect on the table contents of the CPI measurement.

CPI measurements are intended mainly for development engineers in the lab who modify parameters of their workstation and want to investigate the effects thereof on the carrier power. CPW measurements, on the other hand, are aimed at verifying compliance with acceptance test specifications of the GSM standard.

CPI measurements, therefore, are only used for evaluating absolute levels; no relative comparisons are made between the levels obtained with different power control level settings. Operator control is described in the additional information following the description of the softkey menus.

Explanation of Legend:

Selection of CPW measurement, activation of main menu (deactivation of CPI measurement if necessary)

- 3,4 Start of measurement with maximum power in line with standard (CTRL LEVEL 0.0).
- 5,13 End of sweep, result is entered into table.
- 6 Measurement completed?
- 7-12 If a power control level is incremented, the next sweep is started.
- 14 End of measurement, switchover to full screen.

2.1.1 Errors and Failures During Measurements

There are three main sources of error in GSM measurements:

Carrier signal missing:

Causes: Wrong operating frequency (ARFCN), SFH active, test line defective or incorrect attenuation, wrong power class

Effects: Pre-measurement: inadequate power measurement (eg average measurement with SFH), measurement is aborted.
Sweep stops (in measurements with midamble synchronization).

Main measurement: sweep stops when midamble synchronization (PFE, PVT, CPW) is active and number of bursts > 1. When signal is applied again, the sweep continues.

Trigger missing:

In all triggered measurements: sweep stops (indicated by trigger LED).
The following is recommended for the trigger source:

- Optimal solution: External trigger. This allows all measurements without restrictions.
- FreeRun: Allowed for SPU and TRA if not possible otherwise (MOD-Tx without gating also possible).

Burst missing:

Causes: SFH active, wrong frame trigger

Effects: In triggered measurements, limit lines may be exceeded (PVT);
sweep stops (in measurements with midamble synchronization).

2.1.2 Abort of Measurements

a) Abort by User

In manual operation, each running measurement can be aborted by pressing the start key again (ie the key with which the measurement was started).

Starting another measurement likewise causes an abort of the running measurement. This also applies to switchover from SINGLE to CONTINUOUS or LIST, for example.

Measurements are also aborted on exiting the menu in question (New! From 1.90 for *all* measurements) or modifying a test parameter (even in side menus).

All aborts, except for spurious single-step measurements, are without warning. Only if – during a running spurious single-step measurement – the user attempts to restart this measurement or to start the LIST measurement, is he queried to confirm the (re)start before it is made.

For remote control, a special ABORT command is available which causes the current measurement to be aborted (see manual for IEC/IEEE-bus control).

b) Abort by Instrument

Measurements are normally performed until the end. Only in the case of insufficient carrier power (see above) are measurements aborted after the pre-measurement and an error message is output.

If the maximum number of table entries (presently 50) is exceeded in a (spurious) measurement, the measurement is continued but no new entry is made in the table. This does not apply to the CPW measurement, where all possible single results ($7 \times 16 = 112$) are entered in the table. In CPI measurements, the last 40 single measurements are stored.

2.1.3 Results of Measurements

Measurement	Single result	Limit line	Table
PFE	Peak and RMS phase error, frequency error in ppm		
CPW, CPI			One entry per single measurement: CPW: CtrlLevel, measured value, limit value and evaluation CPI: test parameter, measured value and evaluation
PVT		Upper and lower limit line	
MOD SG		Upper limit line	
MOD List Rx/Tx			For each section: One frequency-level entry for each event. One summary entry for each section (see below).
MOD List ARFCN \pm 1.8 MHz			One entry per pair of test points: Frequency offset (\pm), level(-), level(+). Test points defined by standard.
TRA Sgl		Upper limit line	
TRA List			One entry per pair of test points: Frequency offset (\pm), level(-), level(+). Test points at \pm 400, 600, 1200 and 1800 kHz.
SPU			For each section: One frequency-level entry for each event. One summary entry for each section (see below).

The result tables of the MOD-LIST Rx/Tx and SPU measurements are arranged in groups:

The whole measurement range is divided into frequency sections.

A summary entry is generated for each section. This entry contains the section limits and the maximum level of the worst quality class measured in this section. All "events" are then listed as frequency-level pairs, an event being a measured value which lies above limit or at least in the tolerance range.

Each measured value is assigned one of the following quality classes:

- PASSED (best quality class)
- MARGIN
- EXCEPTION
- FAILED (worst quality class)

PASSED values are measured values below the tolerance range.

MARGIN values are values below the limit value but within the (user-definable) tolerance range.

EXCEPTION values are values above the limit value but not exceeding the threshold for outliers.

FAILED values violate both the limit value and the exception threshold.

All measured values except PASSES are events in the above sense.

The section entries (and the table as well) are assigned either PASSED or FAILED as a summary evaluation.

If the number of outliers measured in one section exceeds the value defined by the standard, the section is assigned FAILED even if all events are assigned EXCEPTION in the worst case.

The tables may contain a maximum of 50 lines (except for Carrier Power, where the maximum is 100 lines).

In some measurements, therefore, it may happen that FAILED is indicated as a summary evaluation in the table header although all visible entries in the table are evaluated PASSED.

The reason for this is that the FAILED evaluation might be output in the 65th line only and is therefore not visible.

2.2 Exiting FSE-K11

When FSE-K11 is exited, the status last active is stored so that it can be restored as far as possible on re-opening FSE-K11. The FSE-K11 settings are largely transferred to the other operating modes to allow FSE-K11-conformal measurements also in these modes as far as this is expedient.

FSE-K11 can be exited by:

- Power off
- Preset and mode selection
- <Mode> key and mode selection

Power off

FSE-K11 is restarted (warm start) on power-up of FSE/FSIQ. FSE-K11 is in this case not exited but only interrupted.

Preset

The instrument is reset to a defined default status. This function is comparable to a cold start. For FSE-K11 this means: no re-activation of the status last active when FSE-K11 is re-opened but activation of the default status. The target status of the instrument after a preset is clearly defined independently of the previous FSE-K11 status (see paragraph "Preset" below).

Changing the mode

The target status assumed results from the FSE-K11 status last active and the selected target mode. The parameters for the target mode are set in such a way that measurements in line with FSE-K11 are possible. For changing from FSE-K11 to the analyzer and vector analyzer modes, the following is defined:

Transformation of (FSE-K11) parameters:

Trigger

- TrgSource compatible (if not available in target mode: FreeRun).
- TrgLevel is taken over for all modes (if available).
- TrgDelay corresponding to trigger last active.
- TrgPolarity, TrgEdge/Level are taken over.

Level

- ExtAtt is represented by RefLvl offset.
- RefLevel is set directly.
- RF attenuation is calculated in line with FSE-K11 (AUTO or by formula).

Caution: For RX measurements, the input attenuation is set to AUTO ==> **not to 0 dB!**

Frequency

For the zero span or the vector mode, the ARFCN frequency is set as the center frequency.

For the frequency sweep mode, the start and the stop frequency are selected in accordance with the band last selected:

for TX/RX the band in question (possibly incl. ± 2 MHz),

for TX ± 1.8 MHz the center frequency f (ARFCN) with a span of 3.6 MHz,

for SPU the section last selected (or more simply, the complete band of the non-TX measurement).

Screen Full screen is taken for the analyzer target mode, split screen for the vector target mode (PFE).

Trace Trace assignment in FSE-K11:
2 for single-trace measurements in LIST mode (trace 1 used for table)
1 for single-trace measurements in SINGLE/CONT mode
1,3,2 for PVT measurements with MAX Hold, Average, MIN Hold
2 for SPU measurements
1,3,4 for PFE measurements with MAX Hold, ClearWrite, MIN Hold
2 for CPW/CPI measurements (Average)
Trace assignment is maintained as far as possible.

For changing from FSE-K11 to modes other than the analyzer or vector analyzer modes, the following is defined:

On exiting FSE-K11, the FSE-K11 operating status last active is stored in the newly selected mode (eg RECEIVER mode, or another mode) and activated again by this mode on re-opening FSE-K11.

2.3 Preset

FSE-K11 is reset to the default status. Then the following setting is assumed:

Analyzer default setting: Frequ-Sweep, FullSpan, Sweep Time Auto, RBW/VBW Auto, Trigger FreeRun

2.3.1 Analyzer Mode

The target status assumed results from the FSE-K11 status last active (or the last measurement performed with FSE-K11, respectively).

PFE	Same as PVT.
CPW/CPI	ZeroSpan; $f = f$ (ARFCN); sweep time 540 μ s. Trace 2 is renamed trace 1 because of full-screen display.
PVT	ZeroSpan; $f = f$ (ARFCN); sweep time 800 μ s or 100 μ s.
MOD	FrequSweep; start and stop of span in accordance with TX / ARFCN \pm 1.8 MHz / RX; non-RX: trigger at FreeRun, plus gated sweep with gate length 170 μ s. Otherwise trigger is taken over (setting analogous to CONTINUOUS measurement).
TRA	FrequSweep; span 3.6 MHz, $f = f$ (ARFCN); sweep time in accordance with TRA formula (settings analogous to CONTINUOUS measurement).
SPU	Continuous FrequSweep; start and stop in accordance with frequency range last selected or with band (TX/RX/non-TX); AUTO sweep time. Trigger is taken over. Trace 2 is renamed trace 1 because of full-screen display.

2.3.2 Vector Mode

The PFE status of FSE-K11 (vector mode) is set irrespective of the FSE-K11 status:
split screen with result table at the top and trace at the bottom.

2.4 General Remarks

In the case of the TRA, MOD and PVT measurements, a pre-measurement is performed prior to the main measurement.

This pre-measurement is used for defining the reference point for the limit lines.

In the case of PVT, the pre-measurement takes place in two stages. In the first pre-measurement with max. 2 bursts, the actual level applied is determined. In the second pre-measurement with max. 20 bursts, the exact reference point for the limit lines is determined with an operating point optimally set by means of the result of the first pre-measurement.

In the PFE, CPW and SPU measurements, on the other hand, fixed level values are used and thus no pre-measurements are required.

"ExtAtt" (external attenuation) is taken into account in all measurements in the carrier or non-TX band, "RxGain" for all measurement in the RX band. The values have basically the same effect but are used separately. RxGain can be entered any time, not only for an activated RX band measurement.

In all measurements with Min, Max and Average display, three traces are activated only if the number of sweeps is higher than 1. Likewise, vector triggering operates correctly only if the number of sweeps is set to a value higher than 1 (this too is a feature of the basic unit). If this is not the case, an error message is output, for example "Sync not found" if the midamble is not detected, in which case there is no synchronization to midamble.

Explanation of abbreviations used in the formulas below:

SigPwr	(Expected) signal power, defined by the current settings for the power class and power control level (compare section 3.3.4)
MeasPwr	Measured signal power
CorrPwr	Measured signal power, corrected by a value depending on the bandwidth (30 kHz RBW: +8 dB)
MaxPwr	Maximum (nominal) output power
F(ARFCN)	Operating frequency, resulting from frequency setting (compare section 3.3.3)
TxSup	20 dB or 0 dB is taken into account in the formula depending on whether TX suppression is set to ON or OFF
ExtAtt	External attenuation
RxGain	RX band gain
SFH	SFH (slow frequency hopping) factor: 1 for SFH OFF, 3 for SFH ON
NOB	Number of bursts – value set by the user for the number of sweeps

Examples giving numbers, if any, refer to the default settings on power-up (PGSM-II).

2.5 Standard

Standard P-GSM
 Phase II
 Measurement: SPU-Tx

Type of measurement/band assignment for initial selection of measurement:

PFE CPW PVT MOD TRA SPU
 Single MeasMax Full Single ARFCN ±1.8 MHz List ListTx List

Table 2-1 Parameter values (BTS)

Parameter	PGSM-I	PGSM-II	DCS-I	DCS-II	PCS	E-GSM	R-GSM
ARFCN	1	1	512	512	512	0	0
Frequ [MHz]	935.2	935.2	1805.2	1805.2	1930.2	935.0	935.0
ARFCN-Min/Max	1-124	1-124	512-885	512-885	512-810	975-1023 0-124	955-1023 0-124
ExtAtt [dB]	20	20	20	20	20	20	20
PwrClass	4	4	1	1	1	4	4
PwrCtrLvl	0.0	0.0	0.0	0.0	0.0	0.0	0.0
OutputPwr [dBm]	46	46	43	43	43	46	46
PwrCoupling	ON	ON	ON	ON	ON	ON	ON
SFH	OFF	OFF	OFF	OFF	OFF	OFF	OFF
Tx-Supression	OFF	OFF	OFF	OFF	OFF	OFF	OFF
Limit Margin [dB]	1	1	1	1	1	1	1
Bursts	1	1	1	1	1	1	1
ARFCN-SFH	62	62	573	573	573	13	13
Frequ-SFH							
ARFCN-Min/Max	62-63	62-63	573-824	573-824	573-749	13-63	0-63
ARFCN-B/T	1/124	1/124	512/885	512/885	512/810	975/124	955/124

Table 2-2 Output powers of BTS power ranges:

BTS M1	> 19-24 dBm to > 27-32 dBm
BTS M2	> 14-19 dBm to > 22-27 dBm
BTS M3	> 9-14 dBm to > 17-22 dBm

Table 2-3 General standard specifications

Range	Channel numbers n	Downlink frequency (BS-->MS)	Duplex offset
P-GSM	1 to 124	$f = 890 \text{ MHz} + (n * 0.2 \text{ MHz})$	+45 MHz
E-GSM	0 to 124	$f = 890 \text{ MHz} + (n * 0.2 \text{ MHz})$	+45 MHz
	975 to 1023	$f = 890 \text{ MHz} + ((n - 1024) * 0.2 \text{ MHz})$	+45 MHz
DCS1800	512 to 885	$f = 1710.2 \text{ MHz} + ((n - 512) * 0.2 \text{ MHz})$	+95 MHz
PCS1900	512 to 810	$f = 1850.2 \text{ MHz} + ((n - 512) * 0.2 \text{ MHz})$	+80 MHz
R-GSM	0 to 124	$f = 890 \text{ MHz} + (n * 0.2 \text{ MHz})$	+45 MHz
	955 to 1023	$f = 890 \text{ MHz} + ((n - 1024) * 0.2 \text{ MHz})$	+45 MHz

P-GSM 900	935.2MHz				959.8MHz	FREQ ARFCN
	1				124	
E-GSM 900	925.2MHz	934.8	935	935.2	959.8MHz	FREQ ARFCN
	975	1023	0	1	124	
R-GSM 900	921.2MHz	934.8	935	935.2	959.8MHz	FREQ ARFCN
	955	1023	0	1	124	
DCS 1800	1805.2MHz				1879.8MHz	FREQ ARFCN
	512				885	
PCS 1900	1930.2MHz				1989.8MHz	FREQ ARFCN
	512				810	

Table 2-4 Exceptions and base line values for MOD measurements

Standard	Range	Exceptions	Base line value	Applicable to
PGSM-I	400 kHz to 1800 kHz		-36 dBm	
X-GSM	600 kHz to 6.0 MHz	3 of max. -36 dBm each	-65 dBm -59 / -64 / -69 dBm	PwrClass 1 to 8 PwrClass M1 / M2 / M3
	6.0 MHz to TX band	12 of max. -36 dBm each	-65 dBm -59 / -64 / -69 dBm	PwrClass 1 to 8 PwrClass M1 / M2 / M3
DCS-I	800 kHz to 6.0 MHz	3 of max. -36 dBm each	-57 dBm	PwrClass 1 to 4 (all)
	6.0 MHz to TX band	12 of max. -36 dBm each	-57 dBm	PwrClass 1 to 4 (all)
DCS-II	600 kHz to 6.0 MHz	3 of max. -36 dBm each	-57 dBm -57 / -62 / -67 dBm	PwrClass 1 to 4 PwrClass M1 / M2 / M3
	6.0 MHz to TX band	12 of max. -36 dBm each	-57 dBm -57 / -62 / -67 dBm	PwrClass 1 to 4 PwrClass M1 / M2 / M3
PCS	600 kHz to 6.0 MHz	3 of max. -36 dBm each	-57 dBm -57 / -62 / -67 dBm	PwrClass 1 to 4 PwrClass M1 / M2 / M3
	6.0 MHz to TX band	12 of max. -36 dBm each	-57 dBm / -57 / -62 / -67 dBm	PwrClass 1 to 4 PwrClass M1 / M2 / M3

For details on the individual types of measurement please refer to chapter 3.

3 Measurements with Option FSE-K11

Note: The descriptions of some of the functions are provided with notes pointing out that some functions of FSE-K11 are available only if Vector Signal Analysis Option FSE-B7 is installed. These notes apply only to FSE, since FSIQ contains this option in the basic version.

3.1 Starting the Application

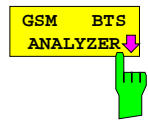
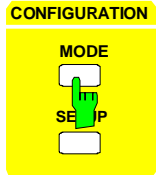

The application is called with the *MODE* key and the *GSM BTS ANALYZER* softkey. A selection menu is offered according to the specific standards with a softkey assigned to each measurement. The presettings are performed in the submenu of the *SETTINGS* softkey or in the right side menu of each measurement.

All settings can generally be performed using the softkeys. In addition, a few hardkeys are available for performing special actions: Hardkey list, availabilities

- Preset
- Print
- Save/Recall

- Marker group (normal, delta)
- Marker-to-trace
- Marker info and search
- Display line
- Time line
- RefPoint (Frequency/Time, RefLevel/RefLevelOffset)

3.2 Menu Overview

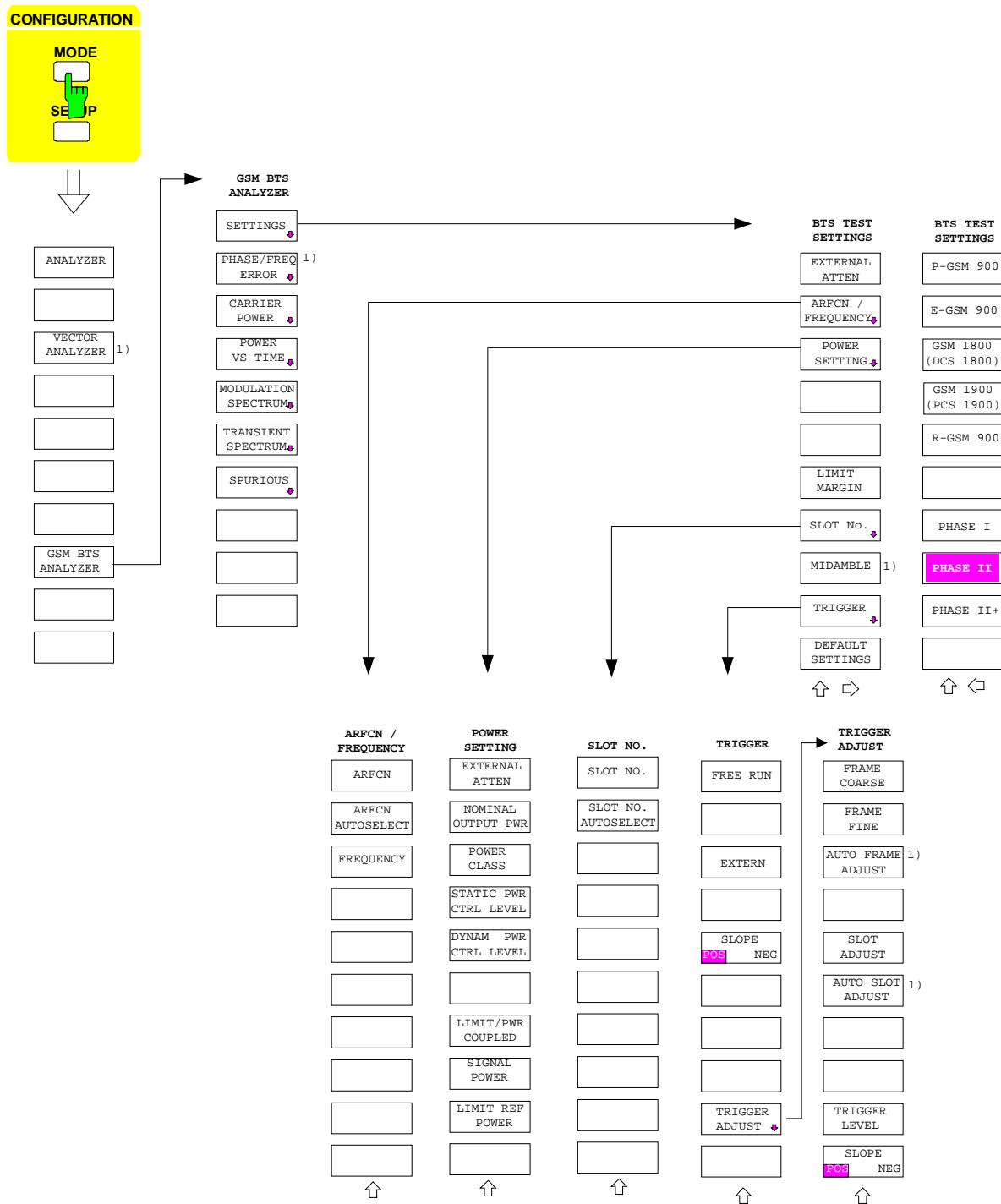

1) only if option FSE-B7 (vector analyzer) is installed

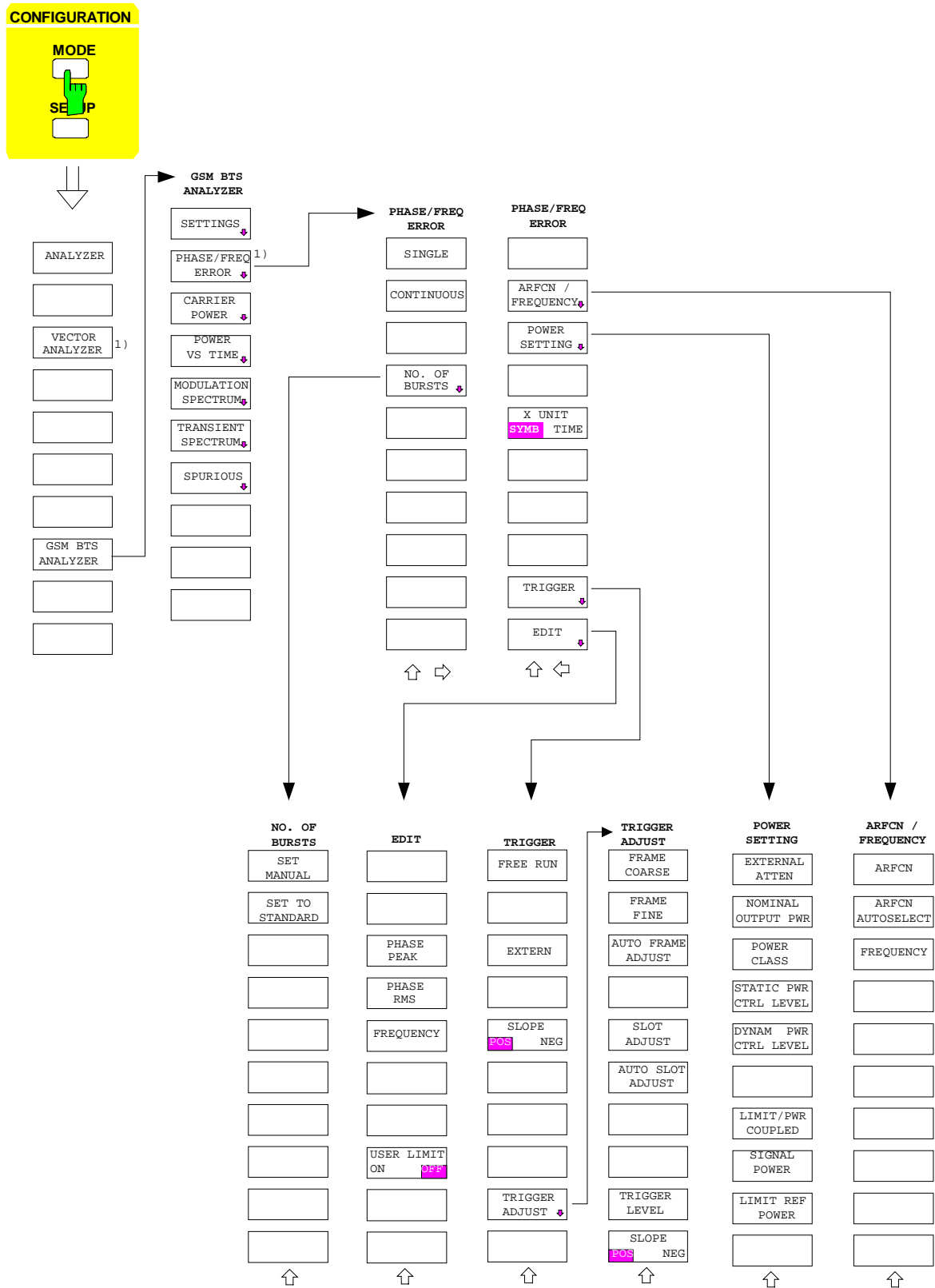

1) only if option FSE-B7 (vector analyzer) is installed

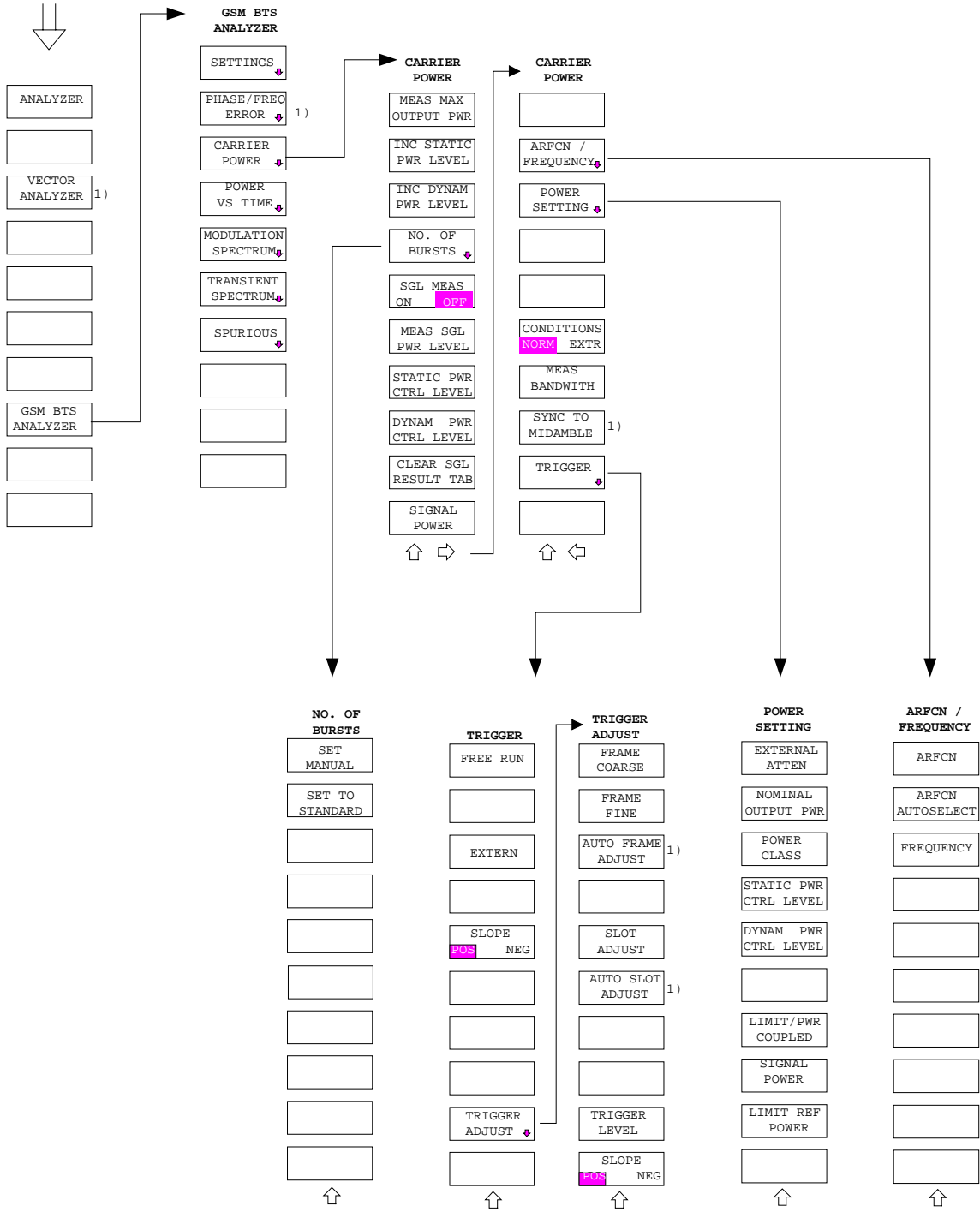
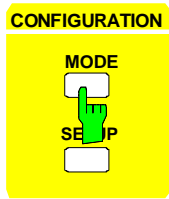

1) only if option FSE-B7 (vector analyzer) is installed

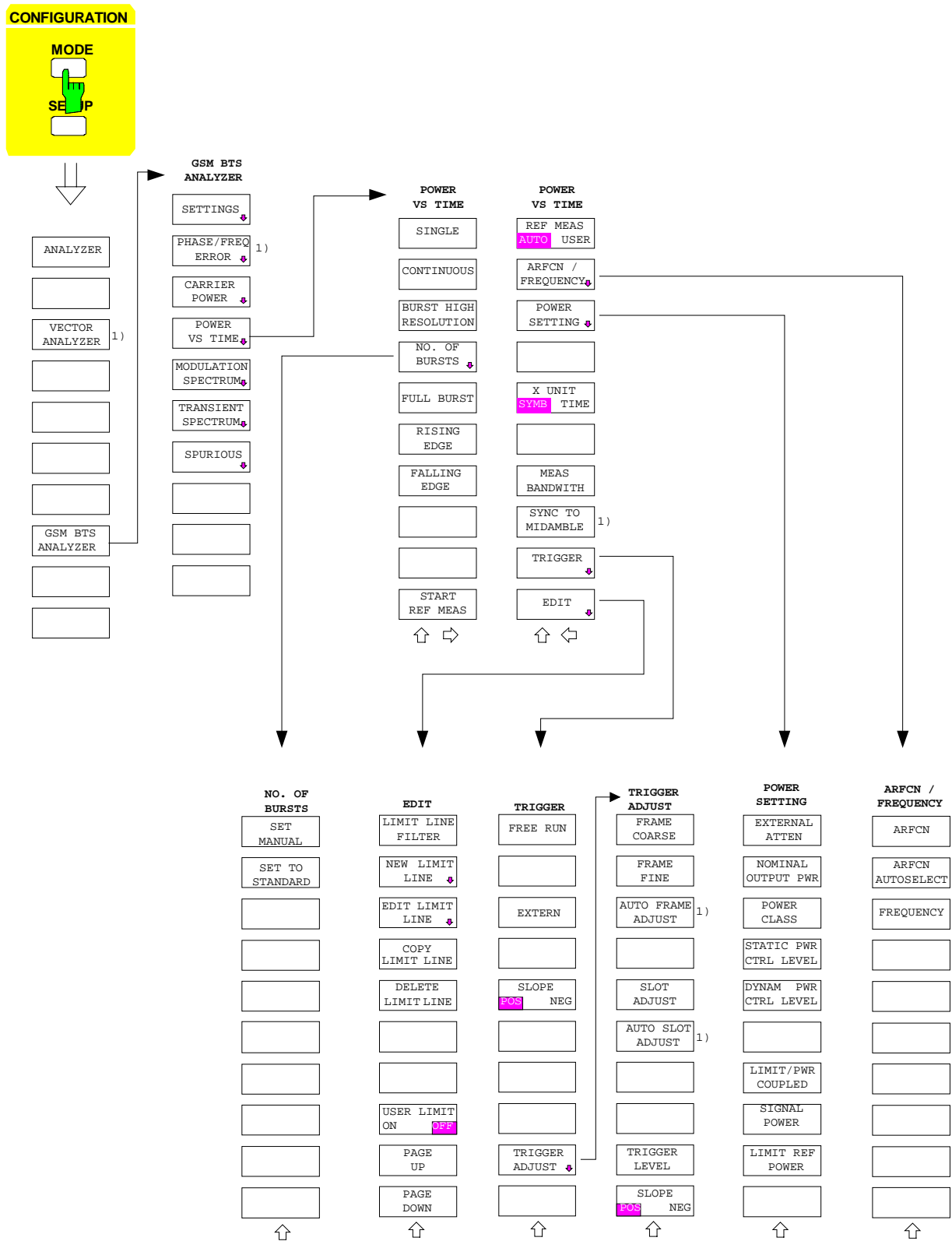

1) only if option FSE-B7 (vector analyzer) is installed

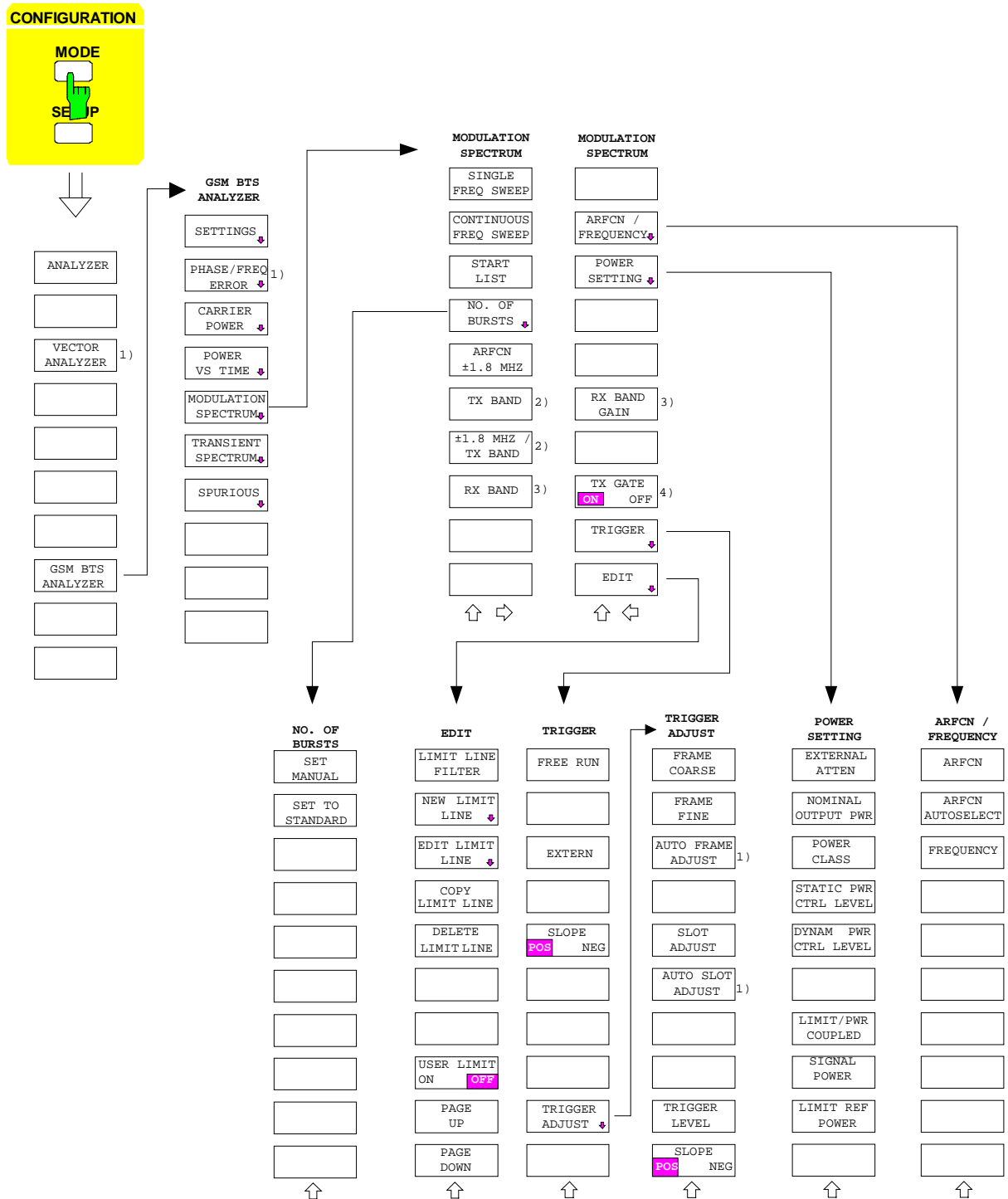

- 1) only if option FSE-B7 (vector analyzer) is installed
- 2) not with P-GSM Phase I
- 3) only with Phase I
- 4) available with activeTX band only

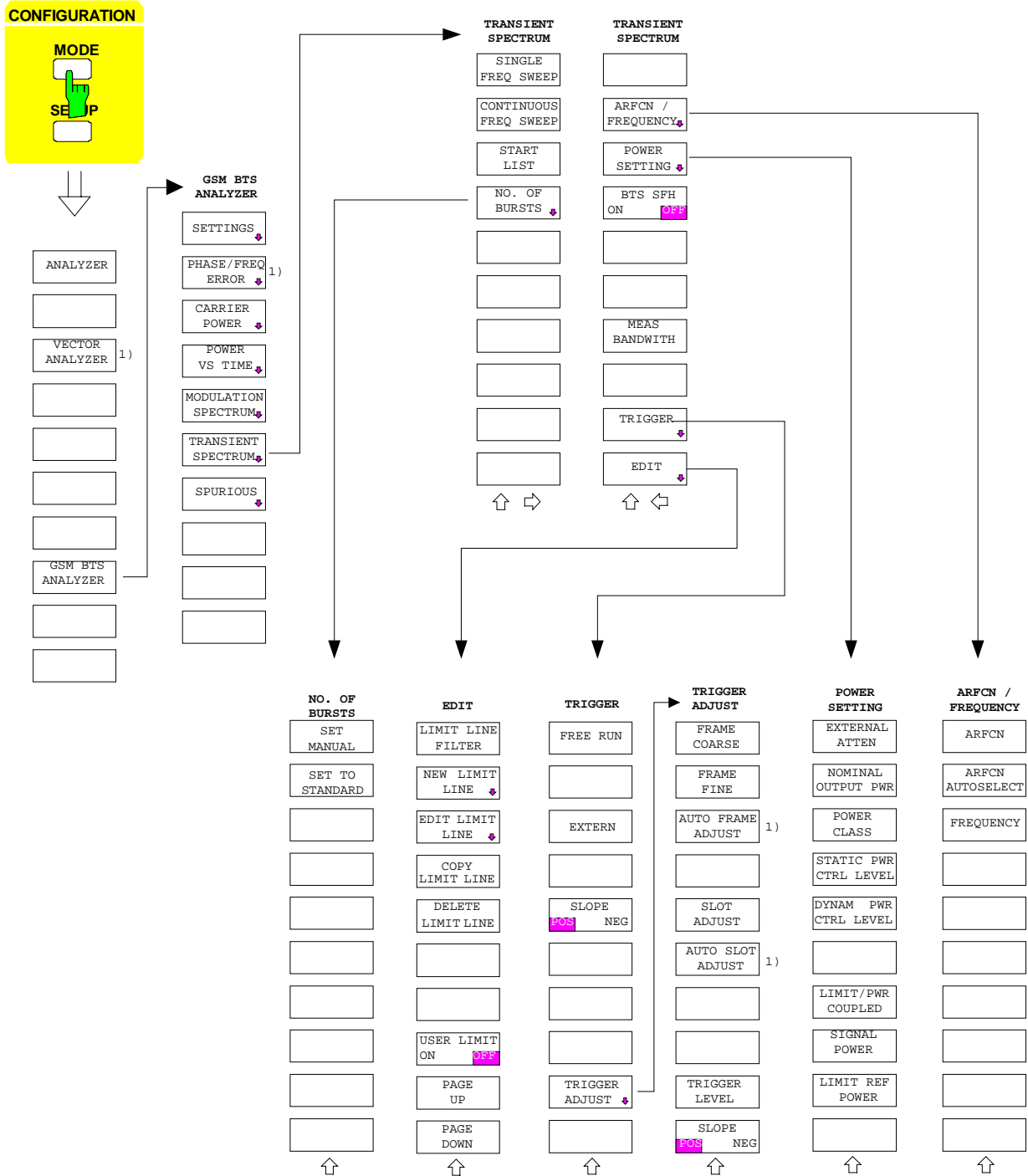

1) only if option FSE-B7 (vector analyzer) is installed

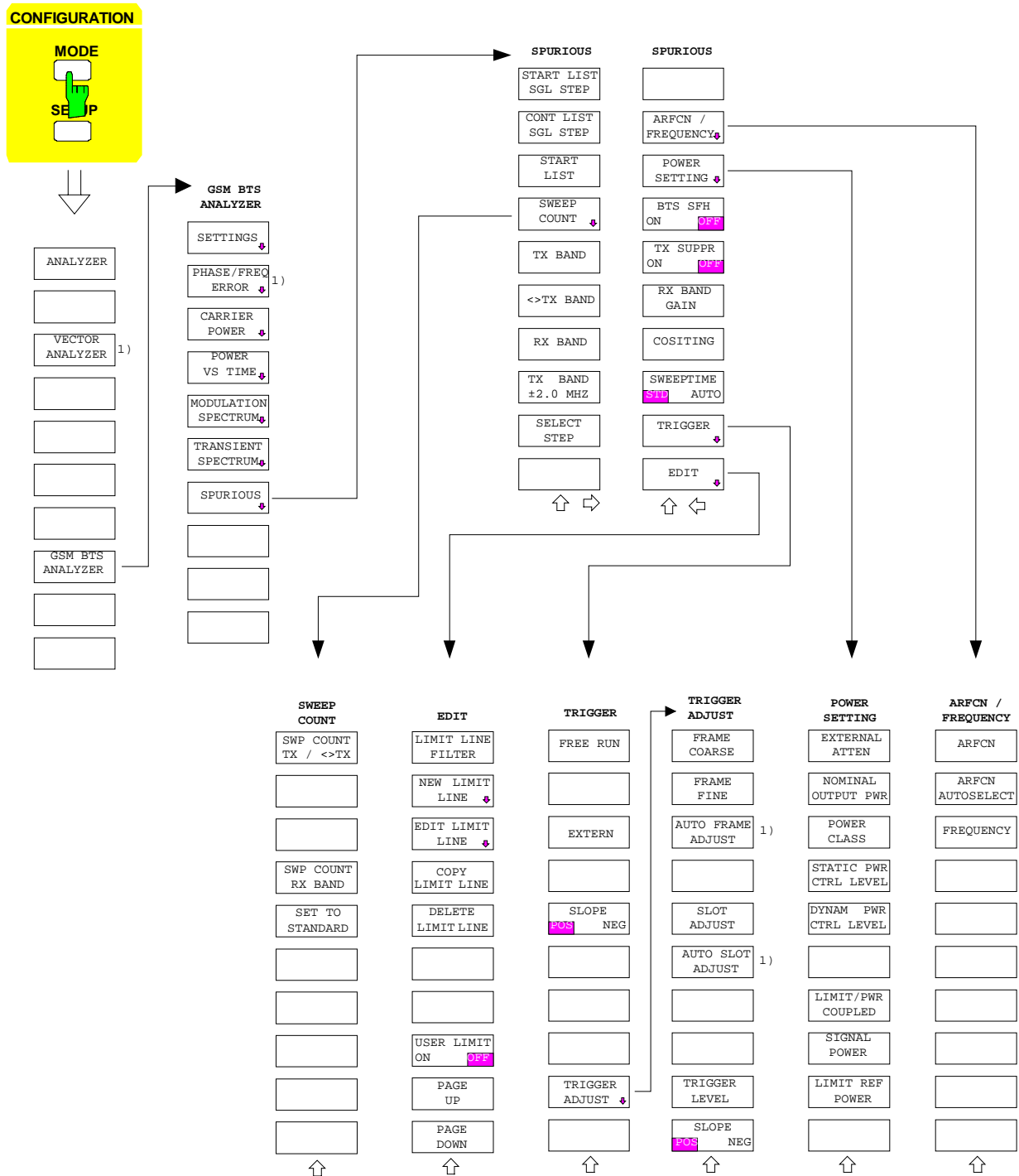

1) only if option FSE-B7 (vector analyzer) is installed

3.3 Selection of Default Settings

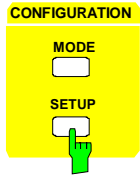

Setting reference frequency

Press SETUP key.

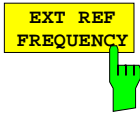

Press *EXT. REF FREQUENCY*  key and enter the frequency according to the frequency standard.

Switch *REF INT/EXT* softkey to *EXT* (external reference frequency).

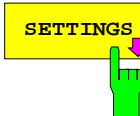
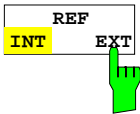

The *SETTINGS* softkey calls the submenu for presetting the test parameters. The associated secondary menu permits to select the transmission system. The parameters to be varied frequently such as channel, power, midamble, etc. are to be found in the main part of the submenu for ease of access.

3.3.1 Selection of the Standard

Menu: *CONFIGURATION MODE - GSM BTS ANALYZER - SETTINGS*

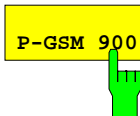

The *P-GSM 900*, *E-GSM 900*, *DCS 1800*, *PCS 1900* and *R-GSM 900* softkeys set the standard to be used for the measurement. The 5 softkeys are selection switches, ie when one is active, the others are automatically deactivated. If a standard is selected, the FSE/FSIQ uses the standard-specific settings and limit values for the measurement.

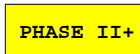
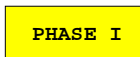
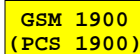
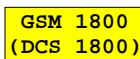

With the standard P-GSM 900/phase 1 the measurement is made according to GSM11.20, with DCS 1800/phase 1 to the ETSI standard GSM 11.20-DCS, with P-GSM 900/phase 2 and DCS 1800/phase 2 as well as E-GSM 900 to the ETSI standard GSM 11.21 and with PCS 1900 to the American standard J-STD-007 Air Interface. The standards GSM 05.05 and GSM 11.21 (also PCS 1900) are also the basis for the measurement of phase II+ (with R-GSM).

The *PHASE I/II/II+* softkeys changes the sequence of measurements and the associated limit values according to the selected phase of the standard.

With some standards, the softkeys are not available (PCS 1900) or partly available because no phases or not all of them are defined.

3.3.2 Consideration of the External Attenuation

For measurements at the RF interface, RF cables, attenuator pads, power splitters, directional couplers or other devices are used to match the level of the RF signal or to connect further test equipment. The attenuation from the RF interface of the transmitter to the RF input of the FSE/FSIQ can be corrected by a constant attenuation factor.

Settings which produce a level >27 dBm at the input of the FSE/FSIQ – taking into account the other settings -are generally not possible with the *EXTERNAL ATTEN* softkey.

To prevent the occurrence of an overload, a warning is displayed for those settings which would lead to the threshold level being exceeded (*POWER CLASS*, *EXTERNAL ATTEN*, *OUTPUT MS POWER*, *POWER CTRL LEVEL*) and the set value is ignored.

Menu: *CONFIGURATION MODE - GSM BTS ANALYZER - SETTINGS*



The *EXTERNAL ATTEN* softkey opens up an input field for setting a level display correction when using an external attenuator. All measured levels and the inscription of the Y-axis of the measurement diagram are shifted by the selected correction value. The effect of the softkey is identical with the input of a level offset (*REF LEVEL OFFSET*) using the *REF* key in the analyzer mode.

Default setting is 20 dB attenuation. This value is to be corrected when another attenuation is used.

The necessary external attenuation depends on the measured maximum output power of the base station to be measured (and on the set static and dynamic power control level).

The maximum input power of FSE/FSIQ **shall never exceed +30 dBm** (even for a short time). Firmware FSE-K11 supports input powers of up to +27 dBm, where

FSE/FSIQ input power = maximum power of BTS – external attenuation.

The external attenuation must not be too high to avoid the S/N ratio of the FSE/FSIQ being affected.

Recommended external attenuation with reference to the maximum base station power:

Max. power	Recommended ext. attenuation
≥ 55 to 60 dBm -	35 dB to 40 dB
≥ 50 to 55 dBm	30 dB to 35 dB
≥ 45 to 50 dBm	25 dB to 30 dB
≥ 40 to 45 dBm	20 dB to 25 dB
≥ 35 to 40 dBm	15 dB to 20 dB
≥ 30 to 35 dBm	10 dB to 15 dB
≥ 25 to 30 dBm	5 dB to 10 dB
≥ 20 to 25 dBm	0 dB to 5 dB
< 20 dBm	0 dB

Note: For measurements in the RX band with modulation spectrum, the attenuation entered with EXTERNAL ATTEN is irrelevant. In this case the RX BAND GAIN softkey has basically the same effect.

The FSE/FSIQ switches to an internal attenuation of 0 dB at the beginning of the measurement and, at the end of it, to the value set prior starting the measurement. The carrier is to be sufficiently suppressed by appropriate measures (eg by means of a bandstop filter). If an external attenuation is used for a measurement in the RX band, it can be taken into account via RX BAND GAIN (negative value of RX BAND GAIN = attenuation in the RX BAND).

If the DUT to be measured has a very high output power, an FSE/FSIQ-internal attenuation (RF ATT) should without fail be set. The 10 dB steps may be excessive in some cases since the noise level increases by approx. 10 dB when adding an attenuation of 10 dB.

If a high dynamic range is required, it is expedient to use an external attenuation (which can be varied in steps smaller than 10 dB in most cases) in order to remedy to the large steps of the RF ATT.

For each dB step of external attenuator, the RF ATT is increased by 10 dB approx. one dB later. This extends the dynamic range.

3.3.3 Setting the Transmission Channel

The operating frequency (ie the carrier frequency) is entered via the ARFCN (Absolute Radio Frequency Channel Number: the transmission band is divided into channels of 200 kHz each of which is identified by means of a standard-dependent number) or directly as a frequency value. In the case of ARFCN entry, the frequency is limited to the standard range of the transmission band. For direct entry of the operating frequency, a range of 1.8 MHz to f_{\max} -1.8 MHz is permissible. However, if the value is out of the transmission band, the band definitions Tx, NTx, Rx are meaningless and thus only measurements referred to the carrier frequency are possible, ie all measurements directly on the carrier – PFE, PVT, CPW/CPI – as well as the relative measurements TRA and MOD-ARFCN \pm 1.8 MHz. If the frequency entered is within the Tx band, the described limitations need not be taken into account.

The search range of the automatic ARFCN determination covers the whole Tx band. Due to the features of the marker-to-peak search, an ARFCN is always determined even if no carrier signal is active in the Tx band.

The parameter values are entered on the FSE/FSIQ via the keyboard, the rollkey or the IEC/IEEE bus.

Menu: CONFIGURATION MODE - GSM BTS ANALYZER - SETTINGS

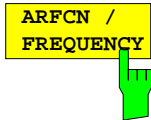

The *ARFCN / FREQUENCY* (Absolute Radio Frequency Channel Number) softkey calls a submenu which offers three possibilities for setting the transmission frequency of the BTS:

1. Setting the ARFCN [as channel number]
2. Automatic searching for the carrier frequency in the frequency band defined by the standard and automatic setting of the found channel or frequency.
3. Entering a frequency in Hz, kHz ...

On calling the menu *ARFCN / FREQUENCY* the input field for the ARFCN generally opens.

With the *FREQUENCY* softkey it is possible to set the frequency freely, ie without limitation imposed by the standard-defined transmission band.

Three cases are distinguished:

1. the entered frequency is exactly on the ARFCN
2. the entered frequency is in the TX band but off a permissible ARFCN
3. the entered frequency is out of the TX band.

The displayed channel number is rounded if the entered frequency does not exactly correspond to an ARFCN.

On entering the menu and quitting the input field, the colour of the softkey indicates the selection (only with a colour display):

1. *ARFCN* is green, *FREQUENCY* is grey
2. *ARFCN* is green, *FREQUENCY* is green
3. *ARFCN* is grey, *FREQUENCY* is green

The center frequencies are assigned to the channels as follows:

P-GSM 900	$F_l(n) = 890 + 0.2 \cdot n$	$1 \leq n \leq 124$	$F_u(n) = F_l(n) + 45$
E-GSM 900	$F_l(n) = 890 + 0.2 \cdot n$ $F_l(n) = 890 + 0.2 \cdot (n-1024)$	$0 \leq n \leq 124$ $975 \leq n \leq 1023$	$F_u(n) = F_l(n) + 45$
R-GSM 900	$F_l(n) = 890 + 0.2 \cdot n$ $F_l(n) = 890 + 0.2 \cdot (n-1024)$	$0 \leq n \leq 124$ $955 \leq n \leq 1023$	$F_u(n) = F_l(n) + 45$
DCS 1 800	$F_l(n) = 1710.2 + 0.2 \cdot (n-512)$	$512 \leq n \leq 885$	$F_u(n) = F_l(n) + 95$
PCS 1 900	$F_l(n) = 1850.2 + 0.2 \cdot (n-512)$	$512 \leq n \leq 810$	$F_u(n) = F_l(n) + 80$

P-GSM 900	935.2MHz				959.8MHz	FREQ
	1				124	ARFCN
E-GSM 900	925.2MHz	934.8	935	935.2	959.8MHz	FREQ
	975	1023	0	1	124	ARFCN
R-GSM 900	921.2MHz	934.8	935	935.2	959.8MHz	FREQ
	955	1023	0	1	124	ARFCN
DCS 1800	1805.2MHz				1879.8MHz	FREQ
	512				885	ARFCN
PCS 1900	1930.2MHz				1989.8MHz	FREQ
	512				810	ARFCN

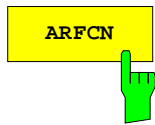

Pressing the *ARFCN* softkey opens an input field in which the desired channel number can be entered.

In the FSE/FSIQ, the center frequency is then set to the frequency specified in the standard to correspond to the selected channel.

If a frequency which lies outside the transmission channel as given by the standard has been selected by means of the *FREQUENCY* softkey, an empty input field is displayed with a message (ARFCN not defined) instead of the channel number.

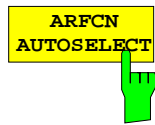

The *ARFCN AUTOSELECT* softkey automatically searches for the transmission channel and sets the center frequency to the channel of the carrier found. The search is performed in a sweep over the entire frequency range of the transmission band ((TX BAND). The maximum level occurring in the transmission channel is searched for with the aid of the marker. The marker frequency is assigned to the respective channel.

The function is performed once after it has been called up.

Frequency hopping is ignored during automatic search (AUTO ADJUST), ie the entire TX band is examined once. The SFH of the BTS should therefore be switched off.

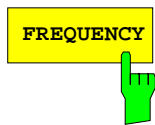

Pressing the *FREQUENCY* softkey opens an input field in which the desired MS frequency can be entered without link to the channel spacing.

The frequency unit (Hz, kHz, MHz) is selected in the DATA ENTRY field with the grey keys next to the numeric keypad.

It is also possible to enter frequencies which are out of the range specified in the selected standard.

If the entered frequency is within the TX band of the selected standard, the channel which is next to the selected frequency (arithmetic rounding) is displayed after pressing the *ARFCN* softkey.

Frequencies in the following range are permissible:

$1.8 \text{ MHz} \leq \text{frequency} \leq (\text{maximum instrument frequency} - 1.8 \text{ MHz})$.

3.3.4 Setting the Transmit Power of the BTS under Test

To make measurements conforming to standards, several power parameters of the BTS under test have to be entered: the nominal power and the actual power to be output by the BTS. The nominal power of the BTS is determined by the power class.

The actual output power of the BTS is determined by the static and the dynamic power control level. The power class defines the maximum possible output power of the base station, whereas the static and the dynamic power control level determine the actual output power.

Limit values which have to be observed during measurements are selected depending on the static and the dynamic power control level, or the actual measured power. The coupling between the limit values and the power control levels can be made inactive in accordance with the procedure described below. It is thus possible to use limit profiles of any power control level with freely selectable actual output power.

To protect the FSE/FSIQ, the settings made in the POWER menu are automatically checked to make sure that the input level to the FSE/FSIQ does not exceed 27 dBm (BTS output power minus attenuation \leq 27 dBm).

To prevent the occurrence of an overload, a warning is displayed for those settings which would lead to the threshold level being exceeded (*POWER CLASS*, *EXTERNAL ATTEN*, *OUTPUT MS POWER*, *POWER CTRL LEVEL*) and the set value is ignored.

Since the power measurement is subjected to very stringent accuracy requirements, the analyzer should not be overdriven.

To prevent this the unit monitors the signal level determined in the preview to establish if the RefLevel is exceeded by more than 1 dB. If this is the case, a warning is output.

In addition to the output power of the DUT the external attenuation or an external amplifier has to be taken into account.

An attenuation value is usually expected. For measurements in the Rx band an amplifier is more suitable so that there are 2 entered values which are exclusively used for the same operation.

- External attenuation (negative value: gain) for all measurements outside the Rx band;
- Rx gain (gain) for all Rx-band measurements (negative value: attenuation).

Menu: CONFIGURATION MODE – GSM BTS ANALYZER – SETTINGS

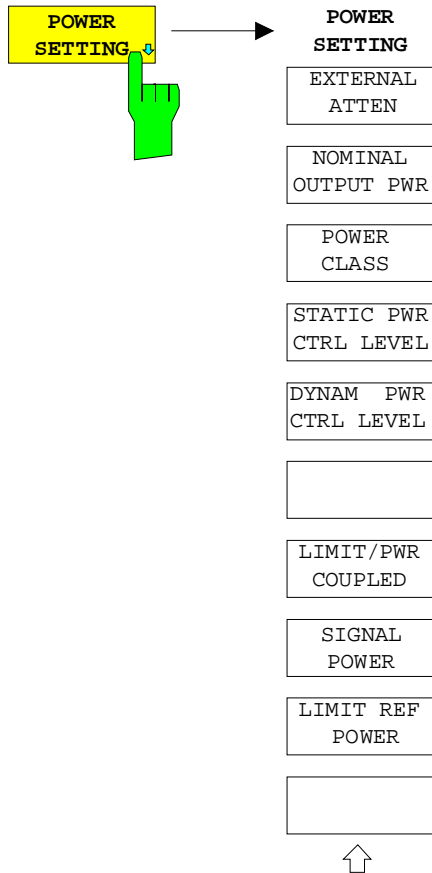

The *POWER SETTING* softkey opens a submenu in which the following settings can be made:

- EXTERNAL ATTEN* Entering the external attenuation
- NOMINAL OUTPUT PWR* Setting the nominal power of the BTS in dBm (equivalent to *POWER CLASS*)
- POWER CLASS* Setting the nominal power of the BTS by entering the power class
- STATIC PWR CTRL LEVEL* Setting the static power level
- DYNAM PWR CTRL LEVEL* Setting the dynamic power level
- LIMIT/PWR COUPLED* Coupling between set power of the BTS and limit values
- SIGNAL POWER* Entering the power expected at the FSE/FSIQ input attenuation taken into account
- LIMIT REF POWER* Setting the power to which limit values should be referred

The softkeys *NOMINAL OUTPUT PWR*, *POWER CLASS*, *STATIC PWR CTRL LEVEL* and *DYNAM PWR CTRL LEVEL* are available only if *LIMIT/PWR COUPLED* is active.

The softkeys *SIGNAL POWER* and *LIMIT REF POWER* are available only if *LIMIT/PWR COUPLED* is inactive.

The softkey *LIMIT/PWR COUPLED* is for switching between "Coupling active" and "Coupling inactive".

LIMIT/PWR COUPLED active:

If the coupling between the limit values used by the FSE/FSIQ and the selected BTS power is activated, the expected BTS output power can be set on the FSE/FSIQ either via *NOMINAL OUTPUT PWR* [in dBm (with accuracy 0.1 dBm)], or via *POWER CLASS* and *POWER CTRL LEVEL* [with the relevant numbers of the power class and the power control levels].

The settings on the FSE/FSIQ (selection of limit values, setting of Ref Lvl, attenuation) are made in accordance with standards corresponding to the selected BTS transmitter power.

LIMIT/PWR COUPLED inactive:

If the coupling between the limit values used by the FSE/FSIQ and the selected BTS power is deactivated, the expected BTS output power can be set on the FSE/FSIQ via *SIGNAL POWER* [in dBm (with accuracy 0.1 dBm)].

The settings on the FSE/FSIQ (Ref Lvl, attenuation) are made corresponding to the selected *SIGNAL POWER*. The selected external attenuation is taken into account.

The limit values selected by the FSE/FSIQ are not coupled to the power setting. With the softkey *LIMIT REF POWER*, the user can freely select the power for which the limit values defined by the standard are set.

In decoupled operation, it is therefore possible to make measurements on or in a BTS (eg ahead of the output amplifier) and select limit values which correspond to a nominal power much higher than that actually output.

NOMINAL
OUTPUT PWR



The softkey *NOMINAL OUTPUT PWR* sets the FSE/FSIQ accurately to the level of the base station (the power class is then assigned automatically). The static and dynamic power control levels are set to 0. These settings can be edited if required.

This softkey is available only if *LIMIT/PWR COUPLED* is active.

Changes to the power class should be avoided, ie such changes should be made only if they are absolutely necessary.

Example:

P-GSM-II: Entry 46dBm =====> PwrClass = 4, PwrCtrlLevel = (0.0)
 Entry 48 dBm =====> PwrClass = 4, PwrCtrlLevel = (0.0)
 Entry 43 dBm =====> PwrClass = 5, PwrCtrlLevel = (0.0)

POWER
CLASS



The softkey *POWER CLASS* opens a table from which the power class, ie the maximum output power of the base station, can be selected.

This softkey is available only if *LIMIT/PWR COUPLED* is active.

The standards define eight classes (plus 3 classes for micro base transmission stations).

With some phases of the standards, power classes are assigned a power range of 3 dB. In such cases, the minimum possible power of the selected BTS power class is set. For a micro base transmitter station, the maximum possible power of the selected power class is set.

The softkey *NOMINAL OUTPUT POWER* is for direct entry of the maximum power; the power class is then assigned automatically in accordance with the tables below.

The power control levels are reset to 0 each time the power class is changed (directly with *POWER CLASS* or indirectly with *NOMINAL OUTPUT POWER*).

The following power classes defined by the standards are available:

Table 3-1

Power Class	Peak power	
	P-GSM 900 - Phase 1	P-GSM 900 - Phase 2
1	320 W (55 dBm)	320 W (55 dBm) - < 640 W
2	160 W (52 dBm)	160 W (52 dBm) - < 320 W
3	80 W (49 dBm)	80 W (49 dBm) - < 160 W
4	40 W (46 dBm)	40 W (46 dBm) - < 80 W
5	20 W (43 dBm)	20 W (43 dBm) - < 40 W
6	10 W (40 dBm)	10 W (40 dBm) - < 20 W
7	5 W (37 dBm)	5 W (37 dBm) - < 10 W
8	2,5 W (34 dBm)	2,5W (34 dBm) - < 5 W
M1	--	(>0,08) – 0,25 W (> 19) - 24 dBm
M2	--	(>0,03) – 0,08 W (> 14) - 19 dBm
M3	--	(>0,01) – 0,03W (> 9) - 14 dBm

Table 3-2

Power Class	Peak power E-GSM 900 - Phase 2 und R-GSM
1	320 W (55 dBm) - < 640 W
2	160 W (52 dBm) - < 320 W
3	80 W (49 dBm) - < 160 W
4	40 W (46 dBm) - < 80 W
5	20 W (43 dBm) - < 40 W
6	10 W (40 dBm) - < 20 W
7	5W (37 dBm) - < 10 W
8	2,5W (34 dBm) - < 5 W
M1	(>0,08) - 0.25 W (> 19) - 24 dBm
M2	(0,03) - 0.08 W (> 14) - 19 dBm
M3	(>0,01) - 0.03W (> 9) - 14 dBm

Table 3-3

Power Class	Peak power	
	DCS1800 - Phase 1	DCS1800 - Phase 2
1	20 W (43 dBm)	20 - (<40W) 43 - < 46 dBm
2	10 W (40 dBm)	10 - (<20W) 40 - < 43 dBm
3	5 W (37 dBm)	5 - (< 10W) 37 - < 40 dBm
4	2,5 W (34 dBm)	2,5 - (<5W) 34 - < 37 dBm
5	--	--
6	--	--
7	--	--
8	--	--
M1	--	(>0.5) - 1.6 W (>27) - 32 dBm
M2	--	(>0.16) - 0.5 W (>22) - 27 dBm
M3	--	(>0.05) - 0.16 W (>17) - 22 dBm

Table 3-4

Power Class	Peak power	
	PCS1900 (W)	PCS1900 (dBm)
1	20≤P0≤40	43≤P0≤46
2	10≤P0≤20	40≤P0≤43
3	5≤P0≤10	37≤P0≤40
4	2≤P0≤5	33≤P0≤37
M1	0.5≤P0≤1.6	27≤P0≤32
M2	0.16≤P0≤0.5	22≤P0≤27
M3	0.05≤P0≤0.16	17≤P0≤22

STATIC PWR
CTRL LEVEL



The softkey *STATIC PWR CTRL LEVEL* defines the actual static power control level.

The static power control level allows the network operator to limit the maximum power of the BTS (power class) and adapt the BTS range to the environment. The maximum power attainable as a result of the selected dynamic power control is set.

With the static power control level = 0, the maximum possible output power of the BTS corresponds to the power defined by the power class.

The default setting of the static power control level = 0 (full power).

This softkey is available only if *LIMIT/PWR COUPLED* is active.

The softkey opens a window, in which the output level is selected by entering one of the numbers 0 to 6. There are 7 static power control levels defined as shown in the table below:

Table 3-5

Power Control Level	Relative Power Referred to Maximum Output Power (GSM/DCS/PCS)
0	0 dB
1	-2 dB
2	-4 dB
3	-6 dB
4	-8 dB
5	-10 dB
6	-12 dB

When a non-permissible power control level (> 6) is entered, the message "Out of range" is displayed in the window.

DYNAM PWR
CTRL LEVEL



The softkey *DYNAM PWR CTRL LEVEL* defines the actual dynamic power control level.

The dynamic power control level allows the network operator to effect downlink power control.

With the dynamic power control level = 0, the maximum possible output power of the BTS corresponds to the power defined by the static power control level.

The default setting of the dynamic power control level = 0 (full power).

This softkey is available only if *LIMIT/PWR COUPLED* is active.

A total of 16 dynamic power control levels are specified, which reduce the level of the base station in max. 16 steps of 2 dB (dynamic power control level N = 0 to 15, attenuation = $N \times 2$ dB) referred to the static power control level.

LIMIT /PWR
COUPLED



With the softkey *LIMIT /PWR COUPLED* it is selected whether the limit values are selected automatically (as a function of the power class and control level settings) or manually with the softkey *LIMIT REF POWER*.

If the coupling is activated, only those softkeys of the menu are available that are located above this softkey.

If the coupling is deactivated, only those softkeys of the menu are available that are located below this softkey, plus EXTERNAL ATTEN.

With *LIMIT /PWR COUPLED OFF* absolute limits and base values are not taken into account.

Hinweis: Bei *LIMIT /PWR COUPLED OFF* werden *Socket bei relativen Limit Lines in Form von absoluten Limits nicht mit berücksichtigt.*

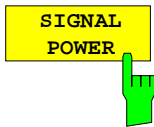

The softkey *SIGNAL POWER* sets the FSE/FSIQ directly to the signal level expected at the FSE/FSIQ input. The selected external attenuation is taken into account.

RF ATT and REF LEVEL are set depending on the settings made under this softkey.

Example: The output power of the BTS is 40 dBm, the external attenuation 20 dB.

SIGNAL POWER = 40 dBm is entered. The FSE/FSIQ is set for an input level of 20 dBm.

This softkey is available only if *LIMIT/PWR COUPLED* is inactive.

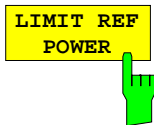

With the softkey *LIMIT REF POWER*, the BTS power is defined to which the limit values selected on the FSE/FSIQ are referred.

The setting made with this softkey is relevant only for the measurements TRANSIENT SPECTRUM and MODULATION SPECTRUM, since absolute limit values are checked just in these measurements.

The entry is made in dBm.

This softkey is available only if *LIMIT/PWR COUPLED* is inactive.

3.3.5 Setting the Limit Margin (limit tolerance range)

Menu: *CONFIGURATION MODE - GSM BTS ANALYZER - SETTINGS*

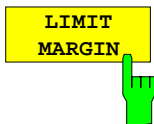

With the aid of this softkey a limit tolerance range can be entered for the measurements SPURIOUS, TRANSIENT SPECTRUM and MODULATION SPECTRUM of the BTS measurement software.

On actuating this softkey, an input field is opened in which the desired tolerance range can be given in dB.

If the value 3 dB is entered here, this means that the tolerance range lies between the limit minus 3 dB and the limit itself (with an upper limit).

If a limit is in this tolerance range, this is indicated by MARGIN (instead of PASSED, FAILED) in the result display for the corresponding measurement.

3.3.6 Selection of the Midamble

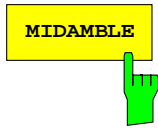

On actuating the *MIDAMBLE* softkey, a selection table is opened in which the midamble used by the BTS can be selected. The midamble is required to determine the time reference only if option Vector Signal Analysis FSE-B7 is installed. If the option is not installed, the softkey is inactive.

The softkey opens a selection table in which all available midambles are offered for selection.

MIDAMBLE	
√	AUTO
	TSC_0
	TSC_1
	TSC_2
	TSC_3
	TSC_4
	TSC_5
	TSC_6
	TSC_7

TSC_0 to TSC_7 (Training Sequence Code) represent the training sequences for the normal burst.

Auto means that the midamble automatically takes the number of the slot number in case the latter is changed.

Example: Selection of the slot with number 4; the midamble 4 is set.

The desired midamble is selected by means of the cursor keys or the rollkey and switched on using one of the unit keys. The selected midamble is marked by a tick.

3.3.7 Selection of the Timeslot

Menu: CONFIGURATION MODE - GSM BTS ANALYZER - SETTINGS

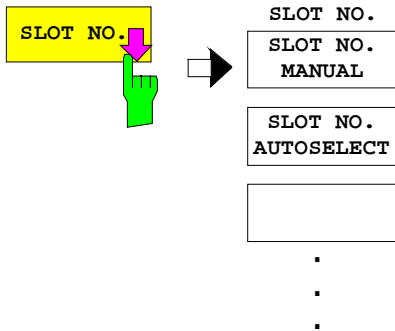

The *SLOT NO.* softkey calls up a submenu for selection of the timeslot to be measured (slot number) .

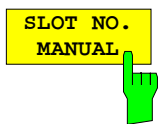

The *SLOT NO MANUAL* softkey activates manual entry of the slot number (0 to 7).

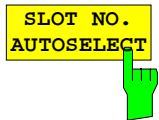

The *SLOT NO AUTO SELECT* softkey searches once for the active slot. A precondition for an automatic search is that only one slot is active. For an automatic detection of the slot the frame trigger of the base station must be connected to the trigger input of the unit and the trigger source set to *EXTERN.*

3.3.8 Setting of the Trigger

BTS measurements require an appropriate trigger so that the time reference between the TDMA burst and the measurement proper can be established. For this purpose, an external trigger signal is usually required, which can be derived from the DUT. Some measurements are possible in the FREE RUN mode.

If an external trigger is used as the FRAME trigger (eg of the CMD), the values obtained from the measurement of the modulation spectrum are falsified. The cause for this is the IDLE burst which appears every 26th frame trigger pulse (the MS is IDLE every 26th frame). This is a problem especially with the measurement of the modulation spectrum during which invalid values are averaged (ie measured values recorded during the IDLE burst). If the 26 MULTIFRAME of the CMD is used as external trigger, the modulation spectrum is measured correctly. But the measurement time is considerably prolonged (the period of the 26 MULTIFRAME is 120 ms). An additional diode detector is used to remedy this. It rectifies the RF and outputs a trigger pulse only if the power is actually present (see also Application Note 1MA01_0D und 1MA06_0D).

The following table shows the possible trigger modes for the different measurements:

Table 3-6 Possible trigger modes for the different measurements

Measurement	Trigger	Midamble Synchronisation (mit FSE-B7 Vektorsignalanalyse)
Phase- / Frequency Error	External	√ (obligatory)
Carrier Power	External	√ (switchable)
Power vs. Time	External	√ (switchable)
Spectrum due to modulation	External / Free run *)	--
Spectrum due to switching	External / Free run	--
Spurious emissions	Extern / Free Run	--

*) In the case of free run the spectrum of DUTs can be measured with continuous modulation.

For measurements of the phase/frequency error, the midamble contained in the burst is used as time reference for triggering. For measurement of the carrier power and the power vs time, the default setting of the time reference is the mode synchronization to the midamble (SYNC TO MIDAMBLE ON) provided the option Vector Signal Analysis FSE-B7 has been installed.

Menu: CONFIGURATION MODE - GSM BTS ANALYZER - SETTINGS

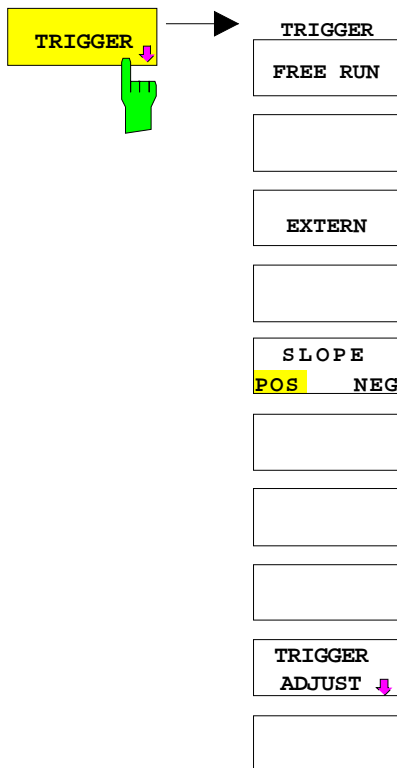

The *TRIGGER* softkey calls the submenu for the selection of the trigger source.

External trigger is the default setting. It is suitable for all measurements.

FREE RUN is relevant for the measurement only if this type of trigger is permissible according to the above table.



The *FREE RUN* softkey activates the free-run mode without trigger.

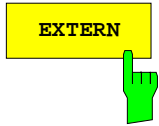

The *EXTERN* softkey activates triggering via an external trigger. On activating the external trigger a window is opened in which a trigger level can be entered.

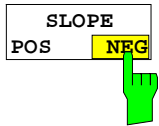

The *SLOPE POS/NEG* softkey selects the trigger slope.

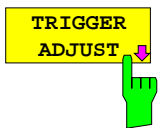

The *TRIGGER ADJUST* softkey calls a submenu in which the trigger can be adjusted.

This adjustment is necessary to establish a time reference of the frame and single slot to the external trigger (in general the frame trigger).

The *AUTO SLOT ADJUST* and *AUTO FRAME ADJUST* functions are possible only if the external trigger is used and the option Vector Signal Analysis FSE-B7 has been installed. This option is required since the midamble available after demodulation by the FSE-B7 is used to establish a high-precision time reference for slot or frame.

Manual trigger adjustment can only be carried out in channels where the BTS sends in bursts because the burst edge is a prerequisite for the manual adjustment.

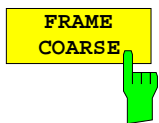

The *FRAME COARSE* softkey activates the manual coarse adjustment of the trigger. The FSE/FSIQ displays the burst with a sweep time of 5 ms in the time domain.

When using an external trigger, the frame coarse value is to be varied such as to set the rising burst edge (-20 dB point) to the middle of the screen. The screen mid-line and the -20 dB display line are used for orientation. The Up/Down keys shift the burst each time by 1/10 scaling (50 μs) to the right or left. Using the rotary knob the burst is shifted by 1/100 of the scaling (= 5 μs) at each detent position.

Important: *FRAME FINE* or *FRAME COARSE* changes the time reference between trigger and **frame**, ie **for all slots**.

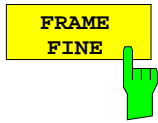

The *FRAME FINE* softkey activates the fine adjustment of the trigger. It represents the burst in a larger resolution by reducing the sweep time to 100 μ s. The rising burst edge (-20 dB point) is to be set to the middle of the screen again.

The \uparrow and \downarrow keys shift the burst each time by half a scaling (= 5 μ s) to the right or left. Using the rotary knob the burst is shifted by 0.5 μ s at each detent position.

The trigger is to be set such that the burst is exactly in the middle of the screen with a roll-off of 20 dB (= value of the horizontal display line). When the menu is quit, FSE/FSIQ stores the trigger settings and uses them for the corresponding measurements. It should be noted that the trigger adjust value is separately stored for each trigger mode. Therefore, the adjustment has to be repeated when the trigger mode is changed.

Caution: *The manual adjustment to the -20 dB point of the trigger edge can deliver the correct time reference by approximation only since the high-precision reference to the midamble is missing and the setting thus depends on the slope of the burst edge. The automatic adjustment delivers the correct time reference to the midamble (depending on the burst edge steepness the -20 dB point can be offset by up to approx. 7 μ s from the screen center). FRAME FINE or FRAME COARSE changes the time reference between trigger and frame, ie for all slots.*

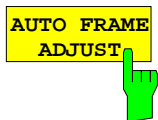
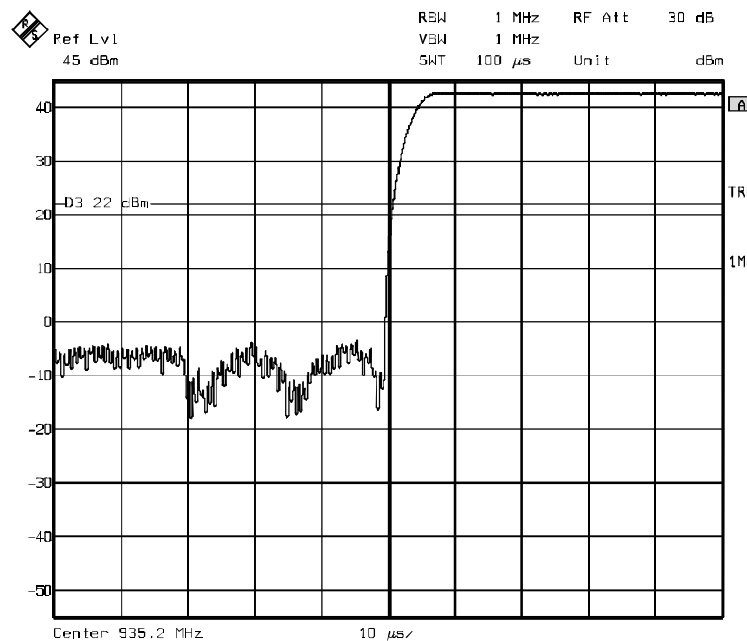

The *AUTO FRAME ADJUST* softkey performs an automatic trigger adjustment of the selected slot with reference to the bit transition 13/14 of the midamble, taking the I/Q demodulator (FSE-B7) into account.

The BTS should send in only one slot.

The set midamble should correspond to that of the selected slot. If the set midamble is not correct, the error message SYNC NOT FOUND shortly appears at the bottom of the display on actuating the softkey.

Important: *AUTO FRAME ADJUST changes the time reference between trigger and frame, ie for all slots.*

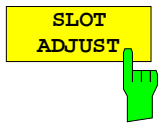

The *SLOT ADJUST* softkey activates the manual coarse adjustment of the trigger referred to the selected slots. It permits the individual slots to be separately adjusted (after a frame adjustment has been performed once). This is of particular importance if the BTS to be tested uses slots of different length (156 and 157 bits) as in this case only the slot used for the adjustment has to be adjusted after the frame adjustment.

The burst is displayed with a sweep time of 100 μs , the rising burst edge is to be set again to the screen center.

The \uparrow and \downarrow keys shift the burst each time by half a scaling (= 5 μs) to the right or left. Using the rotary knob the burst is shifted by 0.5 μs at each detent position.

The trigger is to be set such that the burst is exactly in the middle of the screen with a roll-off of 20 dB (= value of the horizontal display line). Thus the reference between trigger point and midamble is established.

When the menu is quit, FSE/FSIQ stores the trigger settings and uses them for the corresponding measurements. It should be noted that the trigger adjust value is separately stored for each trigger mode. Therefore, the adjustment has to be repeated when the trigger mode is changed.

Caution: *The manual adjustment to the -20 dB point of the trigger edge can deliver the correct time reference by approximation only since the high-precision reference to the midamble is missing and the setting thus depends on the slope of the burst edge. The automatic adjustment delivers the correct time reference to the midamble (depending on the burst edge steepness the -20 dB point can be offset by up to approx. 7 μs from the screen center). *SLOT ADJUST* only changes the time reference between the trigger and **the selected frame**, all the other slots are not changed.*

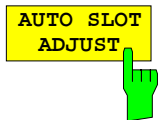

The *AUTO SLOT ADJUST* softkey performs an automatic trigger adjustment of the selected slot with reference to the bit transition 13/14 of the midamble, taking the I/Q demodulator (FSE-B7) into account.

The BTS should send in only one slot.

The set midamble should correspond to that of the selected slot. If the set midamble is not correct, the error message SYNC NOT FOUND shortly appears at the bottom of the display on actuating the softkey.

Important: **AUTO SLOT ADJUST* only changes the time reference between the trigger and **the selected frame**, all the other slots are not unaffected.*

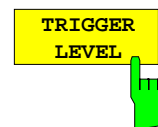

Der Softkey *TRIGGER LEVEL* ermöglicht die Eingabe des Triggerpegels für die Triggerart *EXTERN* während der Betrachtung des gewählten Bursts.

3.3.9 Default Settings

The default settings can be restored using the *DEFAULT SETTINGS* softkeys.

Menu: *CONFIGURATION MODE - GSM BTS ANALYZER - SETTINGS*

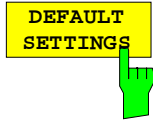

The *DEFAULT SETTINGS* softkey resets the settings of the K11.

See section Default:

Standard, Phase, Measurement

Standard: P-GSM

Phase: II

Measurement: SPU-Tx

Measurement type/band allocation for first selection of measurement:

PFE	CPW	PVT	MOD	TRA	SPU
Single	MeasMax	Full Single	ARFCN ±1.8MHz	List List	Tx List

Table 3-7 Parameter values

Parameter	PGSM-I	PGSM-II	DCS-I	DCS-II	PCS	E-GSM	R-GSM
ARFCN	1	1	512	512	512	0	0
Frequ [MHz]	935,2	935,2	1805,2	1805,2	1930,2	935,0	935.0
ARFCN-Min/Max	1-124	1-124	512-885	512-885	512-810	975-1023 0-124	955-1023 0-124
ExtAtt [dB]	20	20	20	20	20	20	20
PwrClass	4	4	1	1	1	4	4
PwrCtrlLvl	0,0	0,0	0,0	0,0	0,0	0,0	0,0
OutputPwr [dBm]	46	46	43	43	43	46	46
PwrCoupling	ON	ON	ON	ON	ON	ON	ON
SFH	OFF	OFF	OFF	OFF	OFF	OFF	OFF
Tx-Suppression	OFF	OFF	OFF	OFF	OFF	OFF	OFF
Limit Margin [dB]	1	1	1	1	1	1	1
#Bursts	1	1	1	1	1	1	1
ARFCN-SFH	62	62	573	573	573	13	13
Frequ-SFH							
ARFCN-Min/Max	62-63	62-63	573-824	573-824	573-749	13-63	0-63
ARFCN-B/T	1/124	1/124	512/885	512/885	512/810	975/124	955/124

Table 3-8 General standard default settings

Range	Channel Nos n	Downlink frequency (BS-->MS)	Duplex offset
P-GSM	1 to 124	$f = 890 \text{ MHz} + (n * 0,2 \text{ MHz})$	+45 MHz
E-GSM	0 to 124	$f = 890 \text{ MHz} + (n * 0,2 \text{ MHz})$	+45 MHz
	975 to 1023	$f = 890 \text{ MHz} + ((n - 1024) * 0,2 \text{ MHz})$	+45 MHz
DCS1800	512 to 885	$f = 1710,2 \text{ MHz} + ((n - 512) * 0,2 \text{ MHz})$	+95 MHz
PCS1900	512 to 810	$f = 1850,2 \text{ MHz} + ((n - 512) * 0,2 \text{ MHz})$	+80 MHz
R-GSM	0 to 124	$f = 890 \text{ MHz} + (n * 0,2 \text{ MHz})$	+45 MHz
	955 to 1023	$f = 890 \text{ MHz} + ((n - 1024) * 0,2 \text{ MHz})$	+45 MHz

P-GSM 900	935.2MHz	959.8MHz	FREQ ARFCN			
	1	124				
E-GSM 900	925.2MHz	934.8	935	935.2	959.8MHz	FREQ ARFCN
	975	1023	0	1	124	
R-GSM 900	921.2MHz	934.8	935	935.2	959.8MHz	FREQ ARFCN
	955	1023	0	1	124	
DCS 1800	1805.2MHz	1879.8MHz	FREQ ARFCN			
	512	885				
PCS 1900	1930.2MHz	1989.8MHz	FREQ ARFCN			
	512	810				

Fig.: 3-1 Frequency ranges and channel numbers of available standards

3.3.10 Selection and Edition of Limit Lines

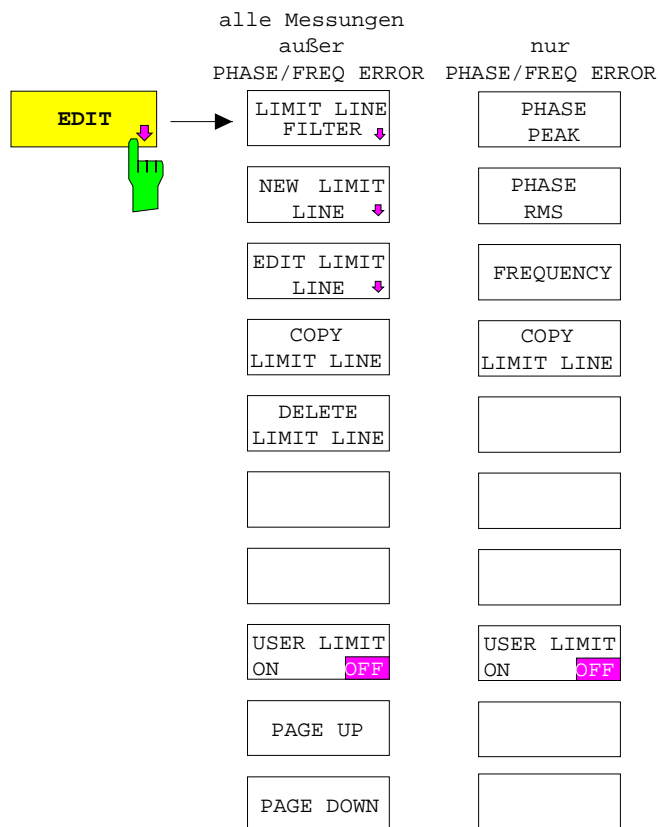

((All measurements except PHASE/FREQ ERROR;
Only PHASE/FREQ ERROR))

The EDIT softkey calls a submenu in which user-specific limit lines can be defined and activated.

The limit lines are edited via the limit line editor (a function of the basic unit).

For the measurement of phase and frequency error, only the values for the phase error and frequency error limit value are entered instead of limit lines. Separate softkeys are available for this purpose.

All limit lines of the GSM software are integrated and available on enabling the option. The names of the lines are displayed on the line.

To edit the available limit lines they should be transferred to the instrument.

To edit the available limit lines, they have to be loaded from the CD-ROM enclosed with Option FSE-K11 into the equipment (see supplement for the CD-ROM).

Some characteristics of the limit lines of the GSM option cannot be manually modified. These are the exceptions and the clipping lines or sockets (... whichever is the highest ...) defined in the standards.

These special characteristics are only available in the GSM software.

The screen center is assigned to the time 0 for limit lines in the time domain. To define limits on the left of the screen center, negative time values have to be entered.

If the user has defined slant limit lines, these are converted into steps in the list mode for the measurements Spurious, Spurious Sgl Step, Modulation and Transient, as explained in the following diagram:

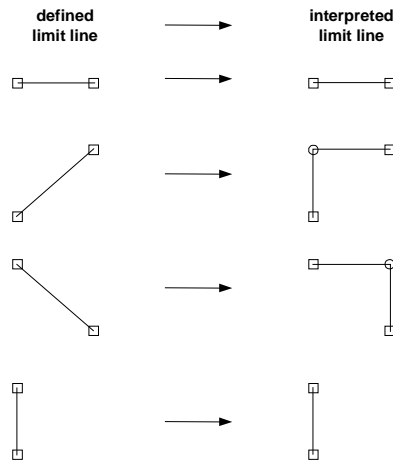
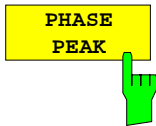

Fig.: 3-2 Conversion of user-defined limit lines



The *PHASE PEAK* softkey can be only accessed from the menu for the measurement of phase and frequency error.

It opens a window in which the limit value for the maximum permissible phase error can be entered in degrees.

The value thus entered is displayed in the evaluation table for the measurement of phase and frequency error in the LIMIT column.

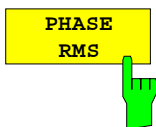

The *PHASE RMS* softkey can be only accessed from the menu for the measurement of phase and frequency error.

It opens a window in which the limit value for the permissible RMS phase error (determined over the 147 usable symbols) can be entered in degrees.

The value thus entered is displayed in the evaluation table for the measurement of phase and frequency error in the LIMIT column.

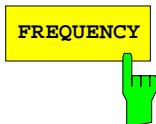

The *FREQUENCY* softkey can be only accessed from the menu for the measurement of phase and frequency error.

It opens a window in which the limit value for the permissible frequency error (determined over the 147 usable symbols) can be entered in ppm or Hz.

The value thus entered is displayed in the evaluation table for the measurement of phase and frequency error in the LIMIT column.

LIMIT LINE
FILTER



The *LIMIT LINE FILTER* softkey permits to filter the limit lines indicated in the table so that only those with the required characteristics are displayed.

The characters * (as replacement for any subsequent characters) and ? (as replacement for any subsequent character) can be used for this purpose.

Example:

There are the following files:

- Abc
- Abd
- Xyc
- Xyd
- Abxydz
- Abxyda

The filter AB* permits to display the following files:

- Abc
- Abd
- Abxydz
- Abxyda

The filter AB? permits to display the following files:

- Abc
- Abd

Consecutive and several ? are permissible in a term.

The *NEW LIMIT LINE* softkey calls a submenu in which a new limit line can be defined.

For further information see manual for the basic unit.

NEW LIMIT
LINE



EDIT LIMIT
LINE



The *EDIT LIMIT LINE* softkey calls a submenu in which an existing limit line can be modified.

For further information see manual for the basic unit.

COPY
LIMIT LINE



The *COPY LIMIT LINE* softkey permits to copy an existing limit line in a new file.

For further information see manual for the basic unit.

DELETE
LIMIT LINE



The *LIMIT LINE FILTER* softkey permits to delete an existing limit line.

For further information see manual for the basic unit.

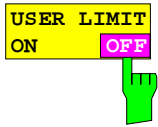

The *USER LIMIT ON OFF* softkey permits to activate or de-activate a user-defined marked limit line associated with the current measurement. The standard setting for this option is *USER LIMIT OFF*.

If *USER LIMIT* is switched to *OFF*, the software remembers the limit lines selected by the user. It is thus possible to change between standard and user-defined limit lines without having to mark again the limit lines every time.

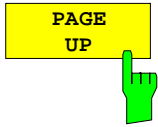

The *PAGE UP* and *PAGE DOWN* softkeys permit to scroll page by page the limit lines available in the list if more than 20 of them are available.



3.3.11 Limit Values and Limit Lines

3.3.11.1 Types of Limit Values

For the measurements PFE and CPW, the limit values are predefined in discrete form, ie with numeric values for specific test points. For CPW these are, for example, the level tolerances between different test steps, for PFE the maximum permissible error for frequency and phase.

In contrast the limit values for the other measurements are given as range limit values: als **Limit Lines**. These lines stipulate a permissible maximum level (for PVT also minimum level) for a particular range (frequency or time domain). An error condition is given when this level is over- or underranged. The indications for these lines can be either *relative* or *absolute* for the two axes independently of each other. The form of indication is specific for the measurement on hand.

Examples of absolute limit lines are for example in the SPU measurement. In this case, the frequency and also the level are explicitly given (eg: 1 GHz – 12.75 GHz / -30 dBm).

3.3.11.2 Calculation of Relative Limit Lines

The actual values for delay are determined with relative lines. For the frequency, the indications generally refer to the carrier frequency (TRA, MOD). The absolute level value is determined relative to a reference level which can be determined in a preview. Time indications (PVT) refer to the center of the midamble.

Examples of relative lines:

K11 MOD:	Offset	Level (>= 43)	Level (41)	... Level (<= 33) [dBc]
(GSM-II)	100 kHz	+ 0.5	+ 0.5	+ 0.5
	200 kHz	- 30	- 30	- 30
	250 kHz	- 33	- 33	- 33
	400 Khz	- 60	- 60	- 60
	< 1200 kHz	- 70	- 68	- 60
	< 1800 kHz	- 73	- 71	- 63

The offset indicates the relative spacing to the carrier frequency (symmetric line) but the level is defined as an absolute value. However, one of the three lines should be selected depending on the set power control stage (in accordance with the nominal output power) of the mobile. A preview is not necessary since all level values are given at the beginning of the measurement.

3.3.11.3 Special Features with Relative Limit Lines

There are other special features and conditions which should be taken into account. In addition to the rules for the determination of the reference point and for the selection of the appropriate line from a whole lot,

- the base Line and
- the tolerance zone (exceptions)

should be considered. The two terms are illustrated using an example.

The **base line** is the limitation of the line to a fixed minimum value (clipping). It is used only with limit lines of the 'upper' type (ie maximum level) in K10/K11. The effect is such that a relative line is limited to this base value at the latest even if the calculation based on the actual reference level would yield lower limit values. The base line is used with PVT, TRA and MOD. With TRA, for example, the limitation is at a maximum S/N ratio of -36 dBm.

Tolerance zones are a speciality of modulation measurement. They indicate a region in which the predefined limit value is exceeded but where a certain number of overranges is tolerated. The combination of base line and tolerance zone is especially interesting.

The following cases are possible:

The different limit line variations are given from left to right. The texts in the different sections specify the evaluation of the signal at this point provided the measured value is in the corresponding section.

The displayed relative limit line cuts the tolerance zone (represented as exception line) and the base line with respect to the reference level.

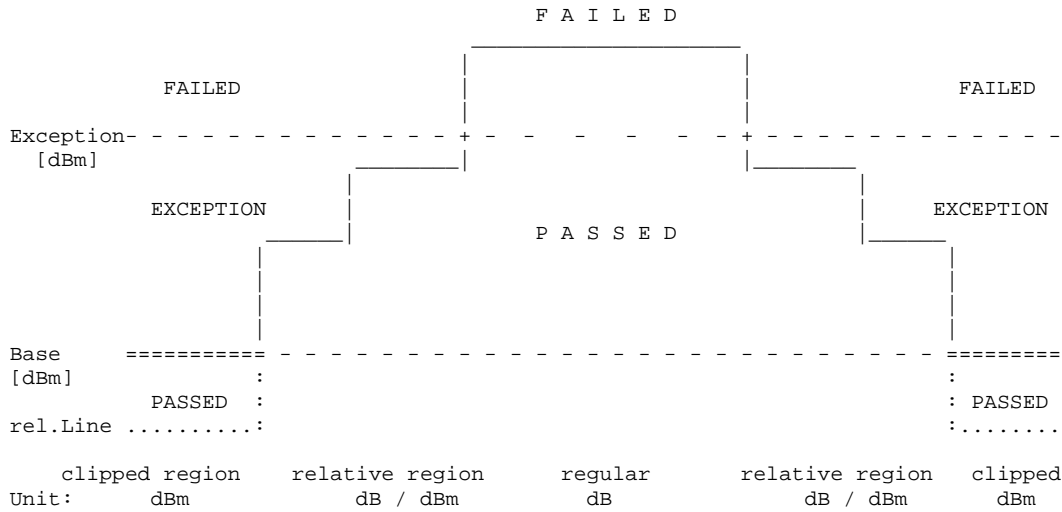

Fig.: 3-3 Arten von Grenzwerten

As explained in detail later, the level unit (dB or dBm) in the result table indicates the type of region in which the measured value lies.

3.3.11.4 Forms of Output

Visual - Trace

The single and continuous measurements graphically reproduce the signal shape and the measured signal is evaluated by means of displayed limit lines. A global evaluation (PASSED/MARGIN/FAILED) is performed by the system and the information is displayed on the screen with the name of the limit line.

Table

The result delivered by LIST measurements is in the form of a table listing the measured sections and test points. A global evaluation is indicated in the table head (PASSED/FAILED/ABORTED) and the test results are given in the table columns.

The global evaluation of the measurement is performed at the end of the single measurements. The indication 'ABORTED' means that the measurement has been aborted by the user and the individual results are thus not complete.

The table contents are explained in detail in the next section.

IEC/IEEE bus

The results of the individual measurement steps can be queried via IEC/IEEE bus. The syntax and semantics of the required commands are indicated in the user manual in the section concerning the IEC/IEEE bus.

3.3.11.5 Table Contents of the Different Measurements

a) General Structure

The tables have all the same structure:

Table head comprising:

Title line
Measurement indications

Table contents comprising:

Title line with column information
Measured values arranged in columns, with
[Indication of section - Summary] (optional)
Individual measured value (table-dependent)
:
Individual measured value (table-dependent)
[Indication of section - Summary] (optional)
:
<Table end>

Examples for the layout of the different tables are given in the section concerning the corresponding measurement.

b) Table Head

The table head is almost identical for all measurements.

The title line contains indications on

- Standard und Phase,
- Measurement and
- Band.

Indication is also given on whether it is a normal measurement (limit lines to standard) or a measurement with user-defined limit lines.

Then the indications on the relevant test parameters are given:

- Channel number (empty if the frequency is not in the standard region)
- Carrier frequency
- Nominal and actual signal level
- External attenuation (or Rx gain)
- No of Bursts and
- Global status of the measurement { PASSED | FAILED | ABORTED }

With CPW the selected measurement condition 'NORMAL' or 'EXTREME' is given instead of the actual signal level.

c) Table Contents CPW

The following columns are available:

- Static power control stage
- Dynamic power control stage
- Measured power [dBm]
- Power difference to the logically previous stage (compare explanations on CPW measurement)
- Evaluation of single measurement: "PASSED" oder ">FAILED<"

d) Table Contents CPI

- ARFCN Channel frequency number ('----' with frequencies outside of the Tx band)
- Status Evaluation of the single measurement (PASSED/FAILED)
- Frequency Carrier frequency (in Hz)
- CarrPwr Measured carrier power (dBm)
- Condition NORMAL/EXTREME condition
- Att/Gain External attenuation (dB)
- NofBursts Number of measurement cycles

e) Table Contents TRA

The results are output for all measurements relative to the carrier:

- Nummer optional, only available with status <> PASSED
- Frequency offset 400 / 600 / 1200 / 1800 kHz
- + Offset Level value for frequency '<carrier frequency> + <offset>'
- - Offset Level value for frequency '<carrier frequency> - <offset>'
- Limit Level indication, either relative or absolute (see MOD)
- Status Evaluation of the single measurement; indication of the "worse" value of the two offset test points

The single status can take the values PASSED, MARGIN or FAILED. All measured values which has not the status PASSED are marked with an asterisk (*) after the unit.

f) Table Contents MOD

The following applies to all result tables: The first column contains an order number which is assigned to all entries which have not the status PASSED. So it is possible to recognize whether a single measurement is ok or not.

Measurement in the carrier band (ARFCN \pm 1.8 MHz)

The results are output for all measurements relative to the carrier:

- Nummer optional, only available with status PASSED
- Frequency offset 100 / 200 / 250 / 400 / 600 / 800 / 1000 / 1200 / 1400 / 1600 / 1800 kHz
- +Offset Level value for frequency '<carrier frequency> + <offset>'
- - Offset Level value for frequency '<carrier frequency> - <offset>'
- Limit Level indication, either relative or absolute (see MOD)
- Status Evaluation of the single measurement; indication of the "worse" value of the two offset test points

The single status can take the values PASSED, MARGIN, EXC or FAILED. All measured values which has not the status PASSED are marked with an asterisk (*) after the unit.

Measurement in the Tx band out of \pm 1.8 MHz

The table contains up to 4 blocks which stands for one of the sections

(- TX ... ARFCN-6), (ARFCN-6 ... ARFCN-1.8), (ARFCN+1.8 ... ARFCN+6), (ARFCN+6 ... +TX)

steht. If the section is empty (because ARFCN lies on the band limit), the corresponding block is completely missing.

Each block has at least a sum line which indicates the range limits (start frequency – stop frequency), the maximum level measured in this range, the associated limit and the global evaluation of this block.

Then the measured values which have not the status PASSED are numbered consecutively.

Under ideal conditions, this list is empty so that the table only contains the 4 range indications.

Incorrect single measurements are output with the following information:

- Order number (1 to n)
- Frequency range 'from – to', in the channel spacing 200 kHz
- Measured level indication in dB or dBm, see below
- Limit value indication in dB or dBm, see below
- Status evaluation of the single measurement, indication of { MARGIN | EXC | >FAILED< }

Level indication for TX and ± 1.8 MHz measurements:

Depending on the position of the test point and the definition of the limit value, the following decision is taken for the table data dB/dBm (see diagram in section on Special Features with Relative Limit Lines)

If the test point is above an absolute line, the measured value and line value are output as absolute values, if both are in the relative region, they are also output as relative values. The 'clipped region' in the above diagram is an absolute line since the relative limit value is limited by an absolute value. The measured value and the limit value are output as absolute values for absolute limit values.

This means in detail:

Table 3-9 Pegelangabe in Abhängigkeit vom Meßwert

Test point	Description	Unit	Evaluation
PASSED	A1	dBm	Position in the absolute region (line limited by base)
EXC	A2	dBm	Tolerance zone, point is in the absolute region (clipped)
FAILED	A3	dBm	Beyond all tolerance
PASSED	B1	dB	Below the regular relative line, base irrelevant
EXC	B2	dB	Above the regular relative line, base irrelevant
FAILED	B3	dBm	Beyond all hope (absolute limit violated)
PASSED	C1	dB	Base and tolerance irrelevant
FAILED	C2	dBm	Relative line violated

C2 F A I L E D

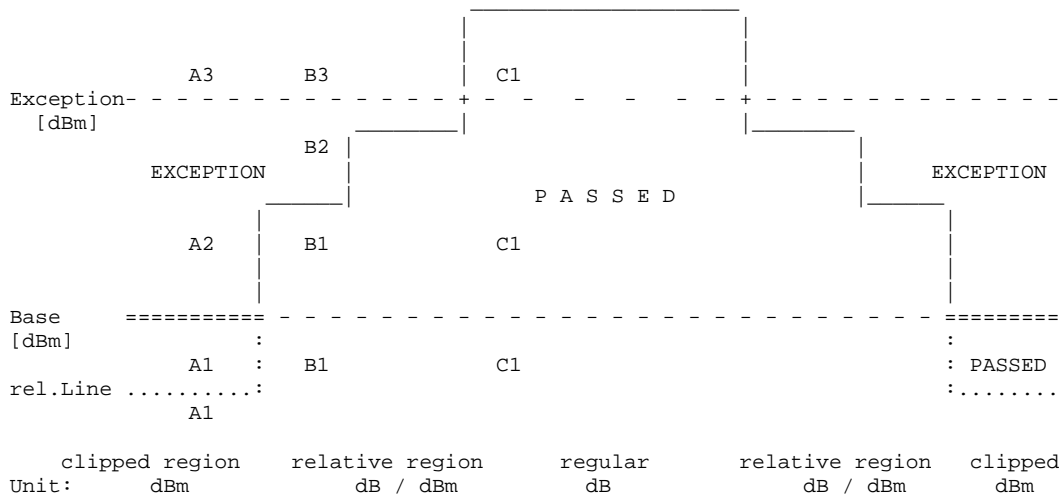

Fig.: 3-4 Arten von Grenzwerten und zugehörige Einheiten

Measurement in the Rx band

All frequencies at which an event occurred are output (event: the measured level exceeds the permissible limit (FAILED) or lies very near to it (MARGIN)). The measurement is performed in steps of 200 kHz. One frequency is output at maximum for each channel.

g) Table Contents SPU

As in the MOD-Tx display the table contains different blocks, each of them standing for a frequency section of the measured band. A section is defined as the frequency range of a band within which identical measurement specifications are given.

Example Tx band PGSM-II: There are here 4 regions related to the carrier frequency, which require various bandwidths depending on the spacing to the frequency.

Example NTx band: The measurement bandwidths and limit values depending on the frequency.
Each block has at least a sum line which indicates the range limits (start frequency – stop frequency), the maximum level measured in this range, the associated limit and the global evaluation of this block.

Then the measured values which have not the status PASSED are numbered consecutively. Under ideal conditions, this list is empty so that the table only contains the range indications.

Incorrect single measurements are output with the following information:

- Order number (1 to n)
- Frequency range 'from – to', depending on the section
- Measured level indication in dBm
- Limit value indication in dBm
- Status evaluation of the single measurement, indication of { MARGIN | EXC | >FAILED< }

3.4 Measurement of Phase and Frequency Error

Note: Measurement of phase and frequency error is possible only if option FSE-B7 (Vector Signal Analyzer) is fitted. If this is not the case, the softkey is not available.

In this measurement, the phase accuracy of each of the 147 useful symbols is determined separately in accordance with GSM 05.05 and GSM 11.21, and the RMS phase error over the useful symbols as well as the maximum phase error are displayed.

From the phase of the symbols, the frequency error is calculated in conformance with standards and displayed.

Menu: CONFIGURATION MODE - GSM BTS ANALYZER

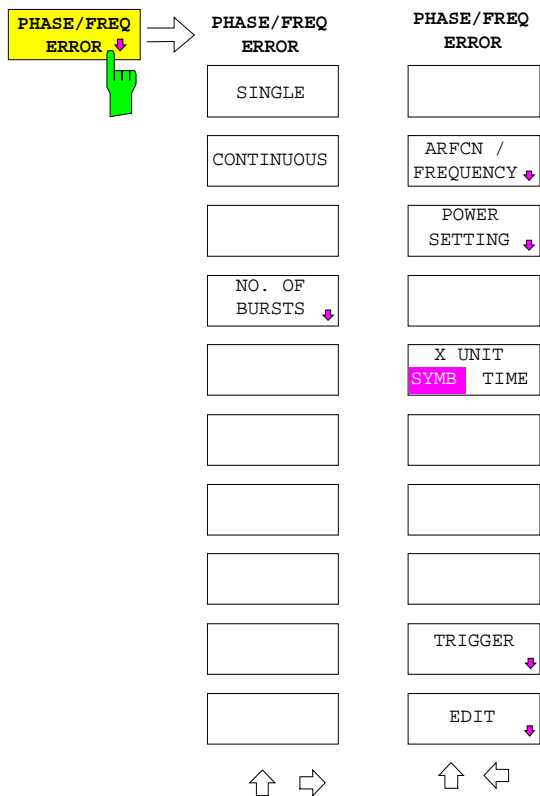

The *PHASE/FREQ ERROR* softkey opens a submenu for configuring the measurement of the phase and frequency error in accordance with the selected standard.

The basic settings can be made in the righthand side menu of this submenu without switching to the *SETTINGS* menu.

In addition, the limit values used can be changed in this submenu by means of the *EDIT* softkey. The settings made with the *EDIT* softkey are effective only for the type of measurement for which they were made.

After completion (and during) the measurement, the summary status of the numeric modulation errors is displayed in window A. Error calculation is performed over the 147 useful bits.

- Max Hold value and average of peak values of phase error
- Max Hold value and average of RMS values of phase error
- Max Hold value and average value of frequency error

Window B displays the phase error versus time, ie over the 147 useful bits of the normal burst. Three traces are displayed at the same time:

- Trace 1: Clear Write
- Trace 2: Max Hold
- Trace 3: Min Hold

The midamble selected in the *SETTING* menu is used for synchronization.

A precondition for the measurement described here is that only one slot of the base station is active. If several slots are active, the desired slot must be selected under *SETTINGS*.

In addition to the standard-stipulated parameters for this measurement, the value for "TRIG TO SYNC START" is displayed, ie the time elapsed between the trigger time and the first bit of the first symbol of the midamble.

This measurement allows, for example, the timing of several transmitters of a BTS to be measured with reference to the trigger with an accuracy of approx. 1/4 of the symbol duration.

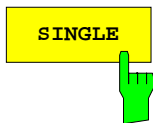

The *SINGLE* softkey triggers a single measurement over the selected number of bursts.

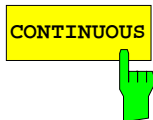

The *CONTINUOUS* softkey triggers a continuous measurement until another measurement function is called up.

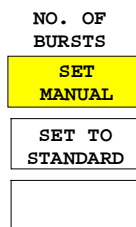
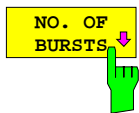

The *NO. OF BURSTS* softkey activates a submenu in which the number of burst to be taken into account in the measurement can be defined.

With the *SET MANUAL* softkey, a user-defined number of bursts can be set. The default setting is 1 burst.

With the *SET TO STANDARD* softkey, the number of bursts stipulated by the selected standard is set.

For the phase/frequency error measurement, this is 200 bursts for all standards.

Note: *With NO. OF BURSTS = 1, 147 symbols are measured after the trigger event (taking into account the delay set under Trigger Adjust), and the result is displayed in a table.*

With NO. OF BURSTS = 1, even measurements are taken into account in which no midamble or burst was found.

With No. of bursts > 1, errors are determined only for those bursts in which the midamble was found.

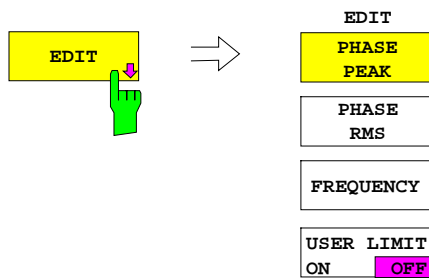

The *EDIT* softkey activates a submenu in which the limit values for the measurement can be defined (see section 3.3.10, "Selection and Setting of Limit Lines").

The limit values for the phase and frequency error can be changed in the respective input windows via the numeric keypad or using the spinwheel. (See also FSE/FSIQ operating manual).



Phase/Frequency Error					
ARFCN:	1			Status:	FAILED
Frequency:	935.20000 MHz				
Carrier Power:	20.00	dBm	Trg to Sync Start:	256.1 μ s	
Ext. Att/Gain:	20.00	dB			
Slot Nr.	0			No. of Bursts:	1
ERRORS	CURRENT	MAX HOLD	AVG	LIMIT	STATUS
Phase Pk	0.78 °	0.78 °	0.78 °	20.00 °	PASSED
Phase RMS	0.28 °	0.28 °	0.28 °	5.00 °	PASSED
Freq	-605.10 Hz*	-614.66 Hz*	-605.10 Hz*	0.05 ppm	FAILED

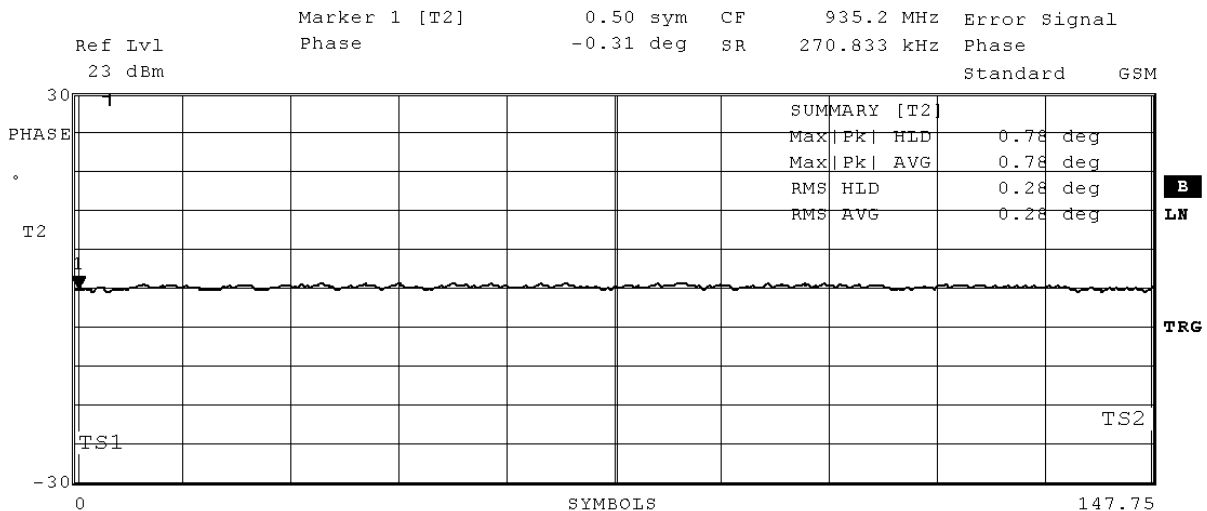

Date: 3.SEP.1999 15:40:33

Fig. 3-5 Measurement of phase and frequency error

Additional Information:

Abbreviations used:	SigPwr	(Expected) signal power, defined by current settings for the power class and power control level	
	F(ARFCN)	Operating frequency determined by the frequency setting	
	NOB	Number of bursts – value set by the user for the number of sweeps	
Pre-measurement:		None	
Main measurement:	Display assignment:	Split screen, display of results above, trace below; vector mode. SingleSweep, ZeroSpan; Center = F(ARFCN);	
	Result:	Max. and average phase errors and max. frequency error plus limit values.	
	Trace:	Phase error versus burst characteristic	
	InpAtt:	Auto Low Noise (min. -20 dBm at mixer)	
	RefLvl:	3.0 + SigPwr	
	Display:	Y unit DEGREES, 6 deg/div	
		X unit SYMBOLS, 148 full-scale	
		Display lines at 0.5 and 147.5 symbols	
	Vector analyzer settings:	Memory size	2048
		Result length	148
		Frame length	300
		Points/symbol	4
		Sync offset	61
		Find	Sync/Burst ON/ON
	Trace 1:	MAX/HOLD	
	Trace 2:	Result	
	Trace 3:	CLEAR/WRITE	
	Trace 4:	MIN/HOLD	
	Trigger delay:	-100 μ s	
	NOB:	200	
Limits:	Phase error (average)	5°	
	Phase error (peak)	20°	
	Frequency error (rel.)	5 * 10 ⁻⁸	

3.5 Measurement of Carrier Power

The carrier power measurement serves to measure the maximum output power of the BTS as well as the powers at the individual power control levels in compliance with the selected standard.

Two test procedures are possible with FSE/FSIQ:

1. All power control levels of the selected power class can be measured starting from the maximum power in descending order in full compliance with standard stipulations (*MEAS MAX OUTPUT PWR, INC STATIC / DYNAM PWR CTRL LEVEL*). The result is displayed in a table.
2. The user can select the power control levels himself and measure them (*MEAS SGL PWR LEVEL, SET SGL CTRL LEVEL, CLEAR SGL RESULT TAB*). The result is displayed in a table with max. 40 entries (lines).

To measure the carrier power, the power in the frequency channel is determined during the 147 useful bits by means of a zero span measurement. Starting from the maximum possible power control level of the selected power class, the power of the BTS is reduced by one power control level at a time (procedure 1) or set to the selected power control level (procedure 2). Each power control level is measured separately.

When the *CARRIER POWER* menu is opened, the measured values last obtained with procedure 1) are displayed in a table. To display the table obtained with procedure 2), press the *SET SGL CTRL LEVEL* softkey. Both tables are empty after a cold start.

Menu: *CONFIGURATION MODE - GSM BTS ANALYZER*

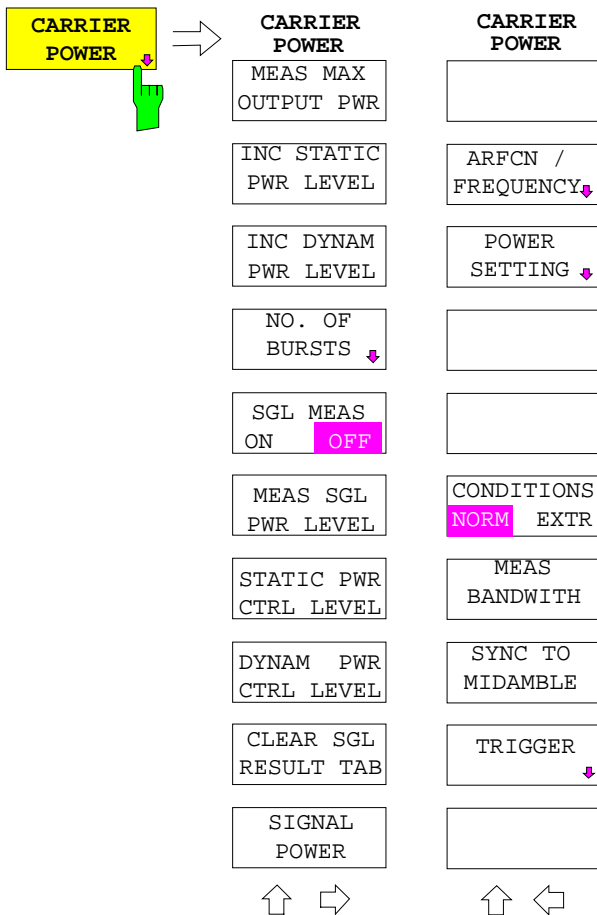

The *CARRIER POWER* softkey opens a submenu for configuring the measurement of the average power of the signal during a burst.

Synchronization to midamble can be effected by pressing the *SYNC TO MIDAMBLE* key (only with option FSE-B7). This function provides an accurate, current time reference. If the key is not pressed, triggering is effected by means of the selected trigger source and the time reference set in the trigger menu (*TRIGGER ADJUST*).

If option FSE-B7 is not installed or *SYNC TO MIDAMBLE* not activated, the trigger time can be corrected with *TRIGGER ADJUST* (trigger menu in side menu of measurement).

Please note that on opening this measurement menu the *MAX SIGNAL POWER* and the *POWER CTRL LEVEL* displayed under *SETTINGS* are set to the maximum possible power of the selected power class.

This setting is retained after exiting the carrier power measurement.

The availability of the softkeys of the *CARRIER POWER* menu depends on the status of the softkeys *SGL MEAS ON/OFF* and *LIMIT/PWR COUPLED* (in the *POWER SETTINGS* menu) in the manner described below. The softkeys of the righthand side menu are always available.

SGL MEAS OFF and *LIMIT/PWR COUPLED*

The following softkeys are available:

- *MEAS MAX OUTPUT PWR*
- *INC STATIC PWR LEVEL*
Only if the reference power was measured with the *MEAS MAX OUTPUT POWER* softkey.
- *INC DYNAM PWR LEVEL*
Only if the reference power was measured with the *MEAS MAX OUTPUT POWER* softkey.
- *NO. OF BURSTS*

SGL MEAS OFF and *LIMIT/PWR* uncoupled

This combination is not meaningful since measurements against limit values are not possible without reference to the power class and power control level.

SGL MEAS ON and *LIMIT/PWR COUPLED*

The following softkeys are available:

- *NO. OF BURSTS*
- *MEAS SINGLE PWR LEVEL*
- *STATIC PWR CTRL LEVEL*
- *DYNAM PWR CTRL LEVEL*
- *CLEAR SGL RESULT TAB*

SGL MEAS ON and *LIMIT/PWR* uncoupled

The following softkeys are available:

- *NO. OF BURSTS*
- *MEAS SINGLE PWR LEVEL*
- *CLEAR SGL RESULT TAB*
- *SIGNAL POWER*

In this case too no reference to the power class and power control level can be established.

However, this setting allows the power to be measured in line with the standard at a single keystroke (*MEAS SGL PWR LEVEL*).

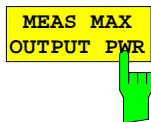

The *MEAS MAX OUTPUT PWR* softkey is used for determining the current average carrier power at full power of the BTS (depending on the currently set power class) and checking it against limit values. The BTS must be set to full power prior to this measurement.

The value obtained in this measurement is the reference for the relative limit values against which the subsequent checks are made.

This measurement function is not available for *LIMIT/PWR* uncoupled.

This softkey is available only if *SGL MEAS* is switched to *OFF*.

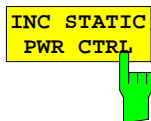

The *INC STATIC PWR CTRL* softkey increments the static power control level in steps of 1 and checks the measured carrier power against the predefined limit value.

This softkey is available only if *SGL MEAS* is switched to *OFF*.

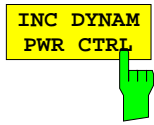

The *INC DYNAM PWR CTRL* softkey increments the dynamic power control level in steps of 1 and checks the measured carrier power against the predefined limit value.

This softkey is available only if *SGL MEAS* is switched to *OFF*.

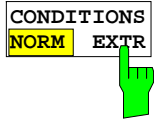

The *CONDITIONS NORM/EXTR* softkey defines whether the BTS is to be checked under normal or extreme conditions. The limit values change correspondingly.

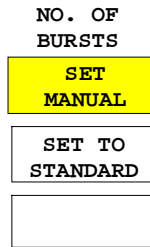
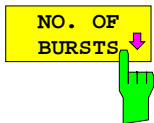

The *NO. OF BURSTS* softkey activates a submenu for defining the number of bursts over which the carrier power is to be averaged.

The *SET MANUAL* softkey enables the entry of a user-defined number of bursts. The default setting is 1 burst.

The *SET TO STANDARD* softkey sets the number of bursts in accordance with the selected standard.

For power measurements the number of bursts is as follows:

- 1000 for GSM/DCS Phase I
- 200 for all other combinations of standards and phase

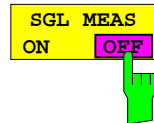

The *SGL MEAS ON/OFF* softkey selects the mode in which the measurement is to be carried out. The default setting is *OFF*.

OFF All power control levels of the selected power class can be measured starting from the maximum power in descending order in full compliance with standard stipulations (*MEAS MAX OUTPUT PWR, INC STATIC / DYNAM PWR CTRL LEVEL*). The result is displayed in a table.

ON The user can select the power control levels himself and measure them (*MEAS SGL PWR LEVEL, SET SGL CTRL LEVEL, CLEAR SGL RESULT TAB*). The results are displayed in a table with max. 50 entries (lines).

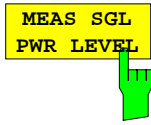

The *MEAS SGL PWR LEVEL* softkey starts test procedure 2 described above. The user can select a power level to be measured.

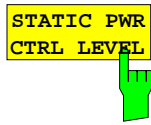

The power control level set by means of the *STATIC PWR CTRL LEVEL* softkey or the *DYNAM PWR CTRL LEVEL* softkey described below is measured. The result is displayed in a table.

If the *MEAS SGL PWR LEVEL* softkey is pressed a second time, the measurement at the set power control level is performed again. The results are displayed in a table in chronological order.

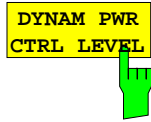

When the 41st entry is made, the first entry of the table is lost because the result table can take up a maximum number of 40 entries (lines) only. The table can be scrolled using the spinwheel and/or the *UP* and *DOWN* keys.

The *STATIC PWR CTRL LEVEL* softkey opens a window for the selection of the static power control level to be measured.

The *DYNAM PWR CTRL LEVEL* softkey opens a window for the selection of the dynamic power control level to be measured.

These softkeys are available only if *SGL MEAS ON/OFF* is switched to *ON*.

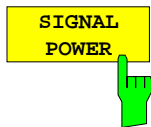

The *SIGNAL POWER* softkey opens a window for entering the actual BTS output power present at the analyzer (the external attenuation is taken into account by the analyzer).

This softkey is identical with the softkey in the *POWER SETTING* menu and available only if the coupling between limits/power classes and actual power is deactivated (*LIMIT/PWR COUPLED* in the *POWER SETTING* menu).

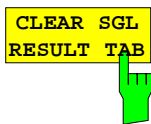

The *CLEAR SGL RESULT TAB* softkey clears the result table created by means of the *MEAS SGL PWR LEVEL* softkey.

This softkey is available only if *SGL MEAS ON/OFF* is switched to *ON*.

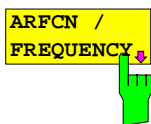

This softkey opens the submenu for frequency setting described under *SETTINGS*.

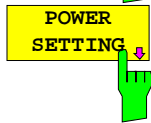

This softkey opens the submenu for power setting described under *SETTINGS*.

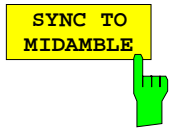

Only with option FSE-B7 (Vector Signal Analyzer):

The *SYNC TO MIDAMBLE* softkey is switched on in the default status, ie synchronization to the midamble of the burst is active. This provides a high-precision time reference for the burst so that it is always presented correctly relative to the limit lines. The midamble can be selected in the *SETTINGS - MIDAMBLE* menu.

SYNC TO MIDAMBLE must be switched off when working with DUTs emitting no midamble. FSE/FSIQ in this case triggers only on the edge of the selected trigger source (see *SETTINGS* menu). The time reference to the 147 useful bits is to be established by appropriate trigger setting.

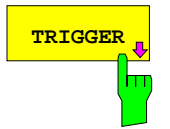

The *TRIGGER* softkey opens the *TRIGGER* submenu for convenient trigger setting.



P-GSM 900 II		CARRIER POWER (INDIVIDUAL)										
No	Ctrl Lvl	ABS POWER	ARFCN	FREQUENCY	COND	EXT ATTN	RBW	BURST COUNT	MEAS POWER	Status		
	S D	dBm		(Hz)		dB	kHz		dBm			
1	5 0	10.00	1	935200000	NORM	20.00	1000	1	9.48	PASSED		
2	5 1	8.00	1	935200000	NORM	20.00	1000	1	7.47	PASSED		
3	5 2	6.00	1	935200000	NORM	20.00	1000	1	5.67	PASSED		
4	5 3	4.00	1	935200000	NORM	20.00	1000	1	2.60	PASSED		
5	5 4	2.00	1	935200000	NORM	20.00	1000	1	-0.48	PASSED		
6	5 5	0.00	1	935200000	NORM	20.00	1000	1	-3.52	>FAILED		

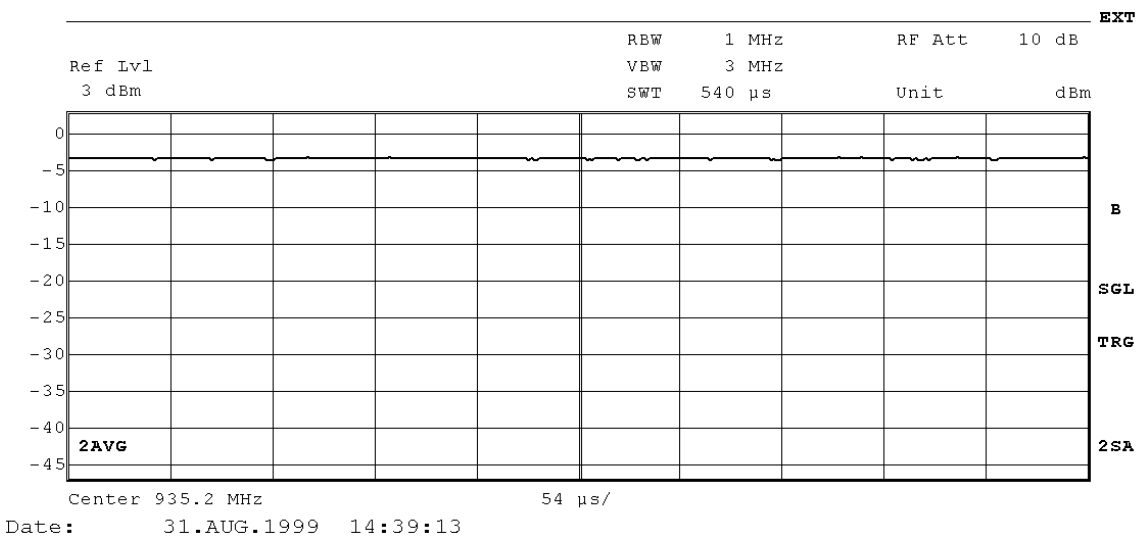

Fig. 3-6 Example of carrier power measurement with *SGL MEAS ON*

3.6 Measurement of Carrier Power Versus Time (Burst Timing)

By measuring the carrier power versus time, the time characteristic of the power of a burst can be determined as well as the position of the burst edges relative to the midamble (only with option FSE-B7).

To this effect, the mask of the selected standard is displayed, and the carrier power versus time is entered into this mask in the ZERO SPAN mode.

This enables the burst length and the power characteristics of the rising and the falling edge to be checked for compliance with the standard.

Moreover, it is possible to synchronize to the midamble of the burst (only with option FSE-B7) to check whether the burst edges come too early or too late relative to the midamble.

Menu: *CONFIGURATION MODE - GSM BTS ANALYZER*

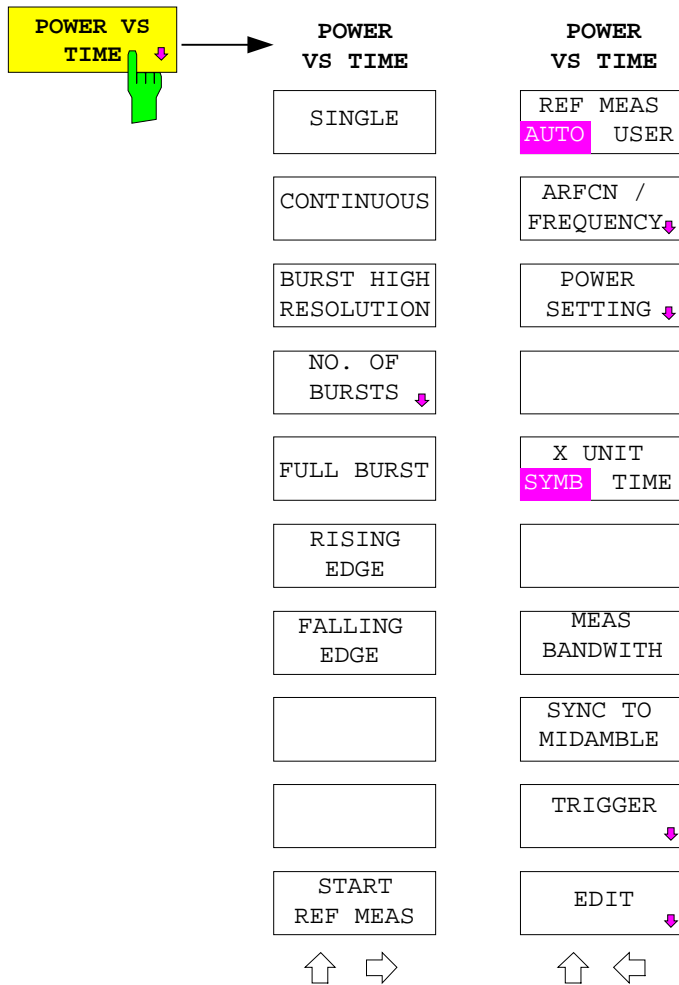

The *POWER VS TIME* softkey opens a submenu for configuring and starting the measurement of carrier power versus time.

Three traces are displayed after the start of a measurement: Max Peak, Min Peak and Average, with limit checks being effected for Max Peak and Min Peak (this applies to number of bursts > 1; for number of bursts = 1 only one trace is displayed).

4 display modes are available:

- Display of complete burst (*FULL BURST*)
- Display of useful part of burst with high resolution (*BURST HIGH RESOLUTION*)
- Display of rising edge of burst (*RISING EDGE*)
- Display of falling edge of burst (*FALLING EDGE*)

When the measurement is activated, the time characteristic of the burst is displayed on the screen provided that the correct settings have been made.

The mask used for the measured-value diagram depends on the selected standard.

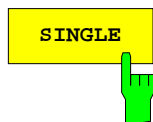

The *SINGLE* softkey activates a single burst measurement (over the number of bursts selected with *NO. OF BURSTS*). In the default setting, FSE/FSIQ measures over one burst.

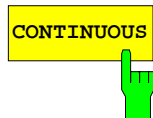

The *CONTINUOUS* softkey activates a continuous measurement.

The following display modes are available:



The *FULL BURST* softkey

- triggers the measurement of a complete TDMA burst including pre-measurement (for level adjustment) (if *REF MEAS* -> *AUTO*).
- selects the display mode so that the complete burst is presented on the screen (if *REF MEAS* -> *USER*). A pre-measurement is not performed.

The relevant limit lines are also displayed.

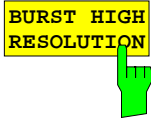

The *BURST HIGH RESOLUTION* softkey

- triggers the measurement of the useful part of a complete TDMA burst with 1 dB/div level resolution including pre-measurement (for correct level setting) (if *REF MEAS* -> *AUTO*).
- selects the display mode so that the useful part of the complete burst is presented on the screen with 1 dB/div level resolution (if *REF MEAS* -> *USER*). A pre-measurement is not performed.

The relevant limit lines for the 147 useful bits are also displayed.

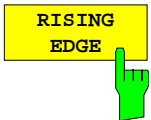

The *RISING EDGE* softkey

- triggers the measurement of the rising edge of a TDMA burst including pre-measurement (for correct level setting) (if *REF MEAS* -> *AUTO*).
- selects the display mode so that the rising edge of the burst is presented on the screen (if *REF MEAS* -> *USER*). A pre-measurement is not performed.

The relevant limit lines are also displayed.

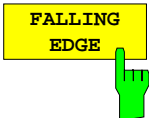

The *FALLING EDGE* softkey

- triggers the measurement of the falling edge of a TDMA burst including pre-measurement (for correct level setting) (if *REF MEAS* -> *AUTO*).
- selects the display mode so that the falling edge of the burst is presented on the screen (if *REF MEAS* -> *USER*). A pre-measurement is not performed.

The relevant limit lines are also displayed.

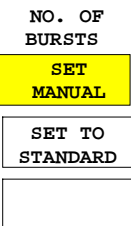
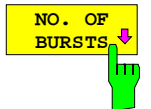

The *NO. OF BURSTS* softkey opens a submenu for defining the number of bursts over which the carrier power is to be averaged.

The *SET MANUAL* softkey opens a window for entering a user-defined number of bursts. The default setting is 1 burst.

The *SET TO STANDARD* softkey sets the number of bursts in accordance with the selected standard.

For power ramp measurements, the stipulated number of bursts is 100 for all standards.

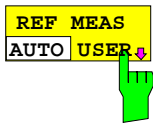

With the *REF MEAS AUTO/USER* softkey it can be selected if a pre-measurement is to be performed prior to each measurement for the correct level setting of FSE/FSIQ or if pre-measurements are to be started exclusively by the user by means of the *START REF MEAS* softkey.

The default setting is AUTO, ie a pre-measurement is performed prior to each measurement.

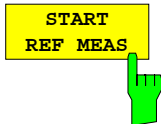

This softkey is available only if REF MEAS USER is selected.

The *START REF MEAS* softkey starts the pre-measurement for the correct level setting for the *Power vs Time* main measurement.

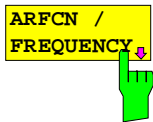

The *ARFCN / FREQUENCY* softkey opens the submenu for frequency setting as described under *SETTINGS*.

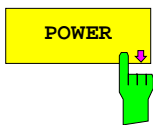

The *POWER* softkey opens the submenu for power setting as described under *SETTINGS*.

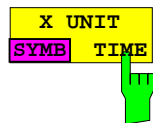

With the *X UNIT SYMB/TIME* softkey it can be selected whether the X-axis unit displayed in the marker field should be time- or symbol-related. The time zero point is at the 1st symbol (symbol No. 0 of the useful bits).

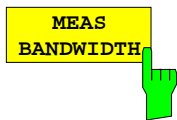

The *MEAS BANDWIDTH* softkey activates a window for selecting the desired measurement bandwidth (300 kHz or 1 MHz).

If *STANDARD* is selected, the measurement bandwidth is set automatically as required for the selected standard and measurement. (For example for GSM Phase I: 300 kHz for *RISING* and *FALLING*, 1 MHz for *HIGH RESOLUTION*).

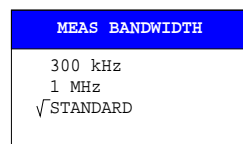

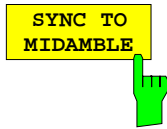

This softkey is available only if the optional Vector Signal Analyzer FSE-B7 is fitted.

In the default setting, the *SYNC TO MIDAMBLE* softkey is activated. This means that synchronization to the midamble of the burst is active (bit 13/14 transition of midamble). This guarantees that an accurate time-reference is always established for the burst. The midamble can be selected in the *SETTINGS/MIDAMBLE* menu.

SYNC TO MIDAMBLE must be switched off when working with DUTs emitting no midamble. FSE/FSIQ in this case triggers only on the edge of the selected trigger source (see *SETTINGS* menu). The time reference to the 147 useful bits is to be established by appropriate trigger setting.

The exact level reference is established by reference to the average power during the useful part (useful bits) of the burst. For this purpose, FSE/FSIQ measures the average carrier power (average over 540 μ s, corresponding to the duration of the useful bits) prior to the screen display and uses it as a reference.

If *SYNC TO MIDAMBLE* is active and *NO. OF BURSTS* > 1, only those bursts in which the midamble is found are taken into account in the measurement. If the set midamble is not found, "SYNC NOT FOUND" is displayed and the evaluation of measured values is stopped. When a burst with the set midamble is received, the measurement is continued automatically.

This characteristic can be used to ensure correct measurements when *SFH* is switched on in such a way that only the bursts at the set ARFCN are taken into account.



The *TRIGGER* softkey opens the *TRIGGER* submenu for convenient trigger setting.

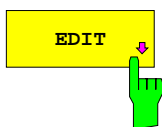

The *EDIT* softkey opens a submenu with 5 softkeys.

In this submenu the user can define his own limit lines for the measurement as described in section 3.3.11, "Selection and Editing of Limit Lines".

FSE/FSIQ displays the mask for the relevant standard in the measurement diagram. The mask used depends on the selected standard and the power class and power control level settings made under *SETTINGS*. The mask can be edited in the EDIT menu.

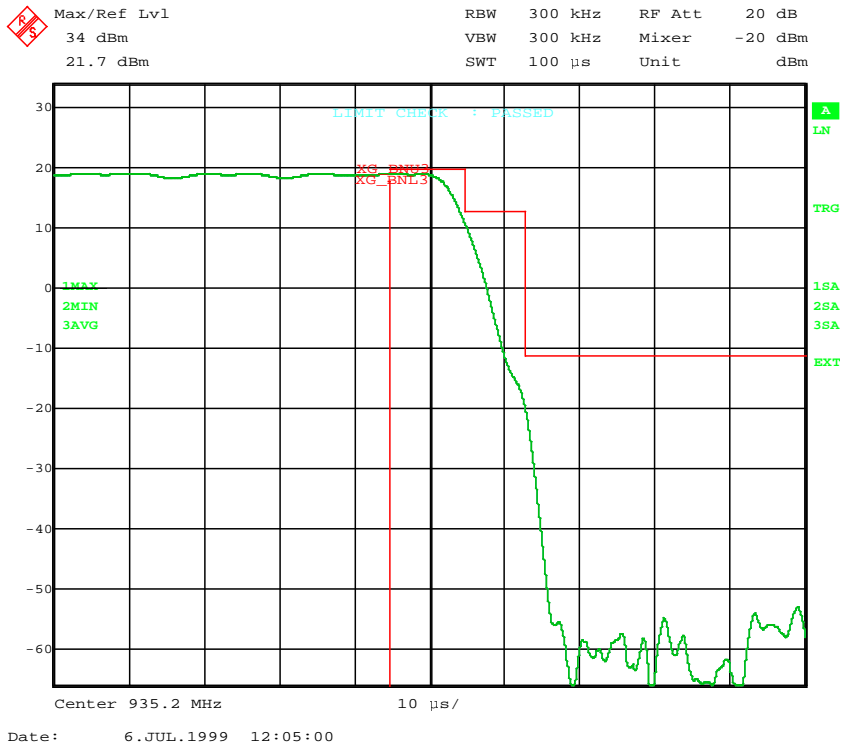

Fig. 3-7 Falling edge of a burst

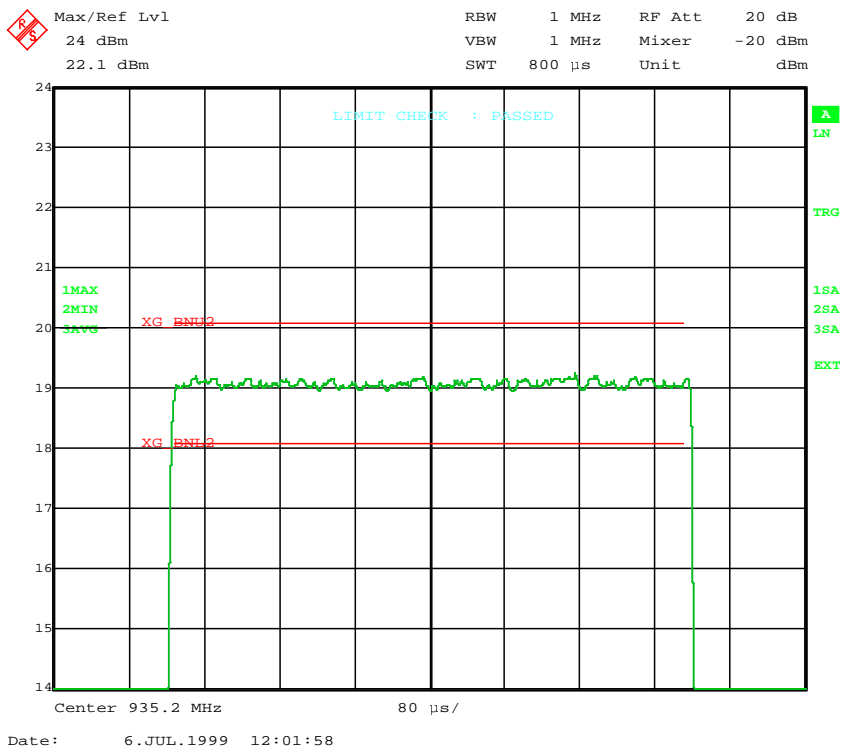

Fig. 3-8 Burst (useful part) in *HIGH RESOLUTION* display mode

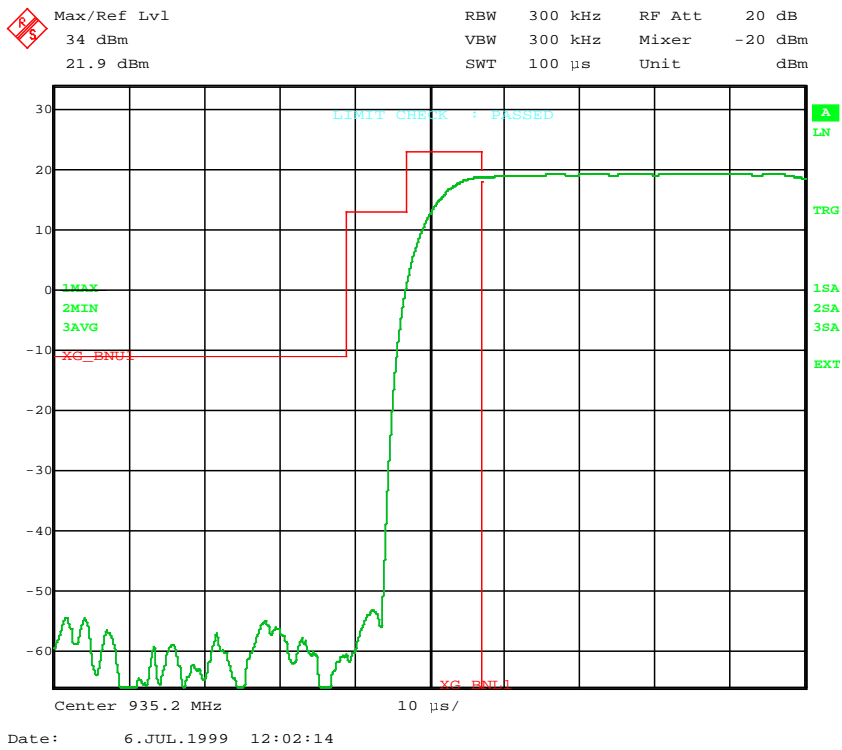

Fig. 3-9 Rising edge of a burst

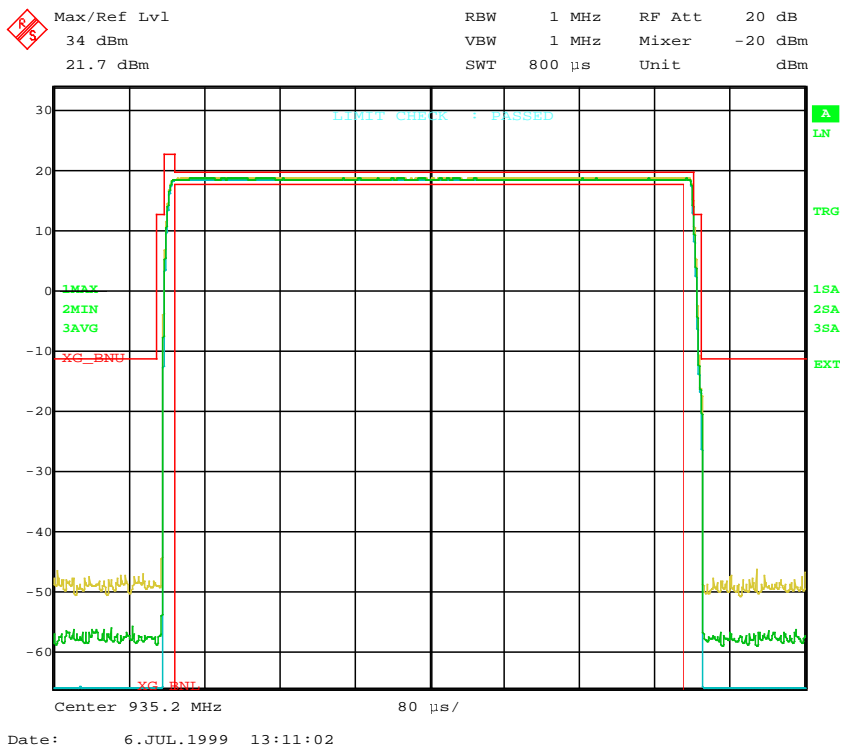

Fig. 3-10 Burst in *FULL BURST* display mode

Additional Information:

The measurement can be performed with or without synchronization to midamble. Midamble synchronization is available only if option FSE-B7 is fitted. Midamble synchronization enables time-synchronized measurements also with unstable trigger signals (time jitter). However, measurements using midamble synchronization are somewhat slower than pure scalar measurements using a fixed trigger reference because they require demodulation.

Settings on opening the menu: (Settings similar to (scalar) main measurement):
 FullScreen, (SingleSweep,) Zerospan; Center = F(ARFCN)
 RBW/VBW Value according to standard (300kHz/300kHz for edges or PCS, 1MHz/1MHz for FullBurst and HighRes) or user-defined (300kHz/300kHz or 1MHz/1MHz)
 InpAtt Auto Low Noise
 RefLvl 3.0 + MaxPwr
 MaxLvl 5.0 + MaxPwr
 Display: Y axis LOG_100 dB
 Trace 1: MAX/HOLD sample
 Trace 2: MIN/HOLD sample
 Trace 3: AVERAGE sample
 Trace 4: BLANK

1st pre-measurement: Level measurement is performed over the complete range of the useful bits.
 FullScreen, (SingleSweep,) Zerospan; Center = F(ARFCN)
 RBW/VBW same as settings on opening the menu
 InpAtt Auto Low Noise
 RefLvl 3.0 + SigPwr
 MaxLvl 5.0 + SigPwr
 Display Y axis LOG_100 dB
 NofBursts Min. 2, otherwise NOB
 Trace 1: BLANK
 Trace 2: AVERAGE sample
 Trace 3: BLANK
 Trace 4: BLANK

2nd pre-measurement: FullScreen, (SingleSweep,) Zerospan; Center = F(ARFCN)
 RBW/VBW same as settings on opening the menu
 InpAtt Auto Low Noise
 RefLvl 3.0 + MeasPwr
 MaxLvl 5.0 + MeasPwr
 Display Y axis LOG_100 dB
 NofBursts Min. 20, otherwise NOB
 Trace 1: BLANK
 Trace 2: AVERAGE sample
 Trace 3: BLANK
 Trace 4: BLANK

Main measurement: FullScreen, (SingleSweep,) Zerospan; Center = F(ARFCN)
 RBW/VBW same as settings on opening the menu
 InpAtt taken from pre-measurement 2
 RefLvl taken from pre-measurement 2
 MaxLvl INT (MeasPwr + {15/5/15/15} + 0.5)
 Display Y axis LOG 100/10/100/100 dB (Full/High/Rise/Fall)
 Trace 1: MAX/HOLD sample
 Trace 2: MIN/HOLD sample
 Trace 3: AVERAGE sample
 Trace 4: BLANK

Limit lines FSE-K11 uses relative limits.
 Base lines: FSE-K11 provides for a base line of -36 dBm only for PGSM-I.
 With uncoupled power setting (LIMIT/PWR COUPLED OFF), no base line is used !

3.7 Measurement of Spectrum due to Modulation

Modulation, broadband noise and the switching of bursts/power control levels may cause significant interference in adjacent bands.

To eliminate this interference, the out-of-channel power caused by modulation is determined by means of the spectrum-due-to-modulation measurement described below.

This measurement includes the stipulated measurement of the modulation spectrum in the RX band both for the user's own standard (eg GSM900) and for the other standards (eg GSM1800).

Menu: *CONFIGURATION MODE - GSM BTS ANALYZER*

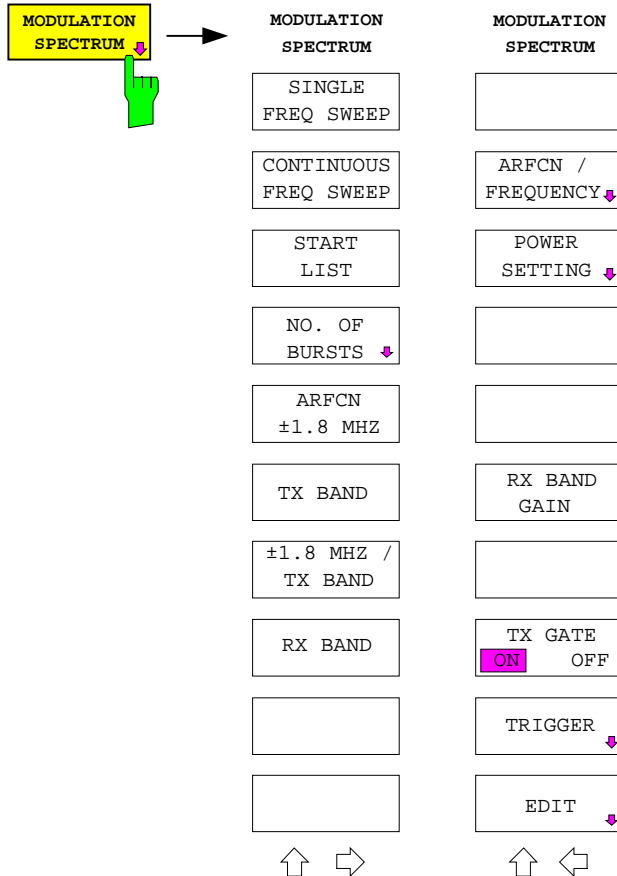

The *MODULATION SPECTRUM* softkey opens a submenu for configuring and starting the measurement of the spectrum due to modulation.

This measurement is always carried out in the analyzer mode with an external trigger.

The measurement can be performed in the zero span mode or in the frequency domain in accordance with standards.

Standards stipulate that a reference level be determined. So, a pre-measurement is performed, and the resulting level serves as a reference for selecting limit values and for checking against relative limit values. For details see section "Additional Information" below.



The *SINGLE FREQ SWEEP* softkey starts a single frequency sweep, the *CONTINUOUS* softkey a continuous frequency sweep.



In both cases, the spectrum is displayed in the form of a trace with limit values depending on the BTS output level, which is determined in the pre-measurement.



The *START LIST* softkey starts a measurement in the zero span mode with the frequency steps and associated bandwidths defined by the standards. During the measurement, results are displayed in two windows. The lower window shows the level versus time for the frequency offset in question, the upper window the measured results in tabular form.

The actual level of the BTS, which is needed for selecting the limit values, is determined in a pre-measurement.

Upon completion of the measurement sequence, results are shown as a table in full-screen display.

For this measurement, an external trigger is to be used for triggering at 50% to 90% of the useful part of the burst.

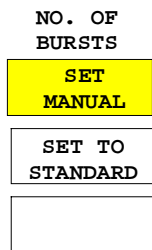
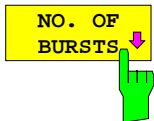

The *NO. OF BURSTS* softkey opens a submenu for defining the number of bursts to be taken into account in the measurement.

The *SET MANUAL* softkey opens a window for entering a user-defined number of bursts. The default setting is 1 burst.

The *SET TO STANDARD* softkey sets the number of bursts in accordance with the selected standard and the selected band.

At each frequency offset, a number of measurements as defined by *NO. OF BURSTS* is performed. A maximum of 2000 bursts can be measured.

The number of bursts can be reduced to increase measurement speed.

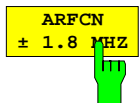

The *ARFCN ±1.8 MHz* softkey starts measurement of the spectrum due to modulation in the range ±1.8 MHz about the set channel.

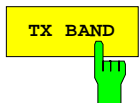

The *TX BAND* softkey starts measurement of the spectrum due to modulation in the TX band (DCS1800 Phase I) far off the carrier (>±1.8 MHz from the channel frequency). In the case of GSM900 Phase II & II+, DCS1800 Phase II and PCS1900, FSE/FSIQ performs the measurements 2 MHz beyond TX band limits. The measurement bandwidth is 100 kHz. With GSM900 phase I, measurement of the spectrum due to modulation is not mandatory for the complete transmission band. The *TX BAND* softkey, therefore, is deactivated for this standard.

Note: *This measurement is available only for GSM900 Phase II & II+, DCS1800 Phase I and II and PCS1900, but not for GSM900 Phase I.*

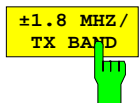

The *±1.8 MHz /TX BAND* softkey is available only in the LIST mode.

FSE/FSIQ measures the ±1.8 MHz and TX BAND frequency ranges one after the other and outputs complete results in the form of a table on completion of the test routine.

Note: *This measurement is available only for GSM900 Phase II & II+, DCS1800 Phase I and II and PCS1900, but not for GSM900 Phase I.*

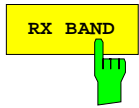

The *RX BAND* softkey (only for GSM900, Phase 1 and DCS1800 Phase 1) selects the RX band of the base station for measuring the spectrum due to modulation.

The spectrum-due-to-modulation measurement in the RX band in the LIST mode corresponds to the spurious measurement in the RX band specified by GSM 11.20 and GSM 11.20-DCS.

With *START LIST*, the measurement is performed in accordance with standards in the time or the frequency domain, with *SINGLE FREQ SWEEP* or *CONTINUOUS FREQ SWEEP* it is performed in the frequency domain.

The stringent specifications for spurious measurements in the RX band make it absolutely necessary for BTS with combined RX input / TX output to provide sufficient suppression of the carrier signal(s) (max. carrier level <-10 dBm at FSE/FSIQ input), for example by using bandstop filters or diplexers.

For BTS with a separate RX input, the TX channel is always sufficiently suppressed at the RX input.

With *RX BAND* selected, FSE/FSIQ is set to 0 dB attenuation to achieve maximum sensitivity. The *RX BAND GAIN* softkey allows the gain of an external preamplifier to be entered which is then taken into account in the FSE/FSIQ display.

The attenuation of an external attenuator entered under *SETTING* is ignored in the measurement of the RX band.

Caution: *The level of +20 dBm at the FSE/FSIQ input must in no case be exceeded with 0 dB attenuation of the input attenuator.*

A warning to this effect is output when the *RX BAND* softkey is activated:

Caution:

Connect bandpass or bandstop to suppress TX band!

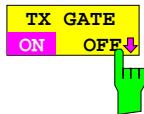

With the *TX GATE ON/OFF* softkey, the gating in the TX band (not including the ± 1.8 MHz range close to the carrier) can be switched on or off.

According to standards, measurements without gating are permissible in this range.

With the *TX GATE ON/OFF* softkey set to *OFF*, measurements are performed over the entire frame! The trigger/gate settings are not needed in this case since the FreeRun trigger mode is active after the pre-measurement.

In this case all slots of a frame must be switched on.

3.7.1 Result Table

Frequency points whose measured values are within permissible limits are marked "PASSED". Frequency points for which the limit check yields FAILED or MARGIN are assigned consecutive numbers in the No. column.

Measured values that violate the limit value or the margin are marked with an asterisk (*). Measured values exceeding the limit value are output as absolute levels in dBm.

3.7.2 Test Setup

Test setup for BTS with combined RX input / TX output:

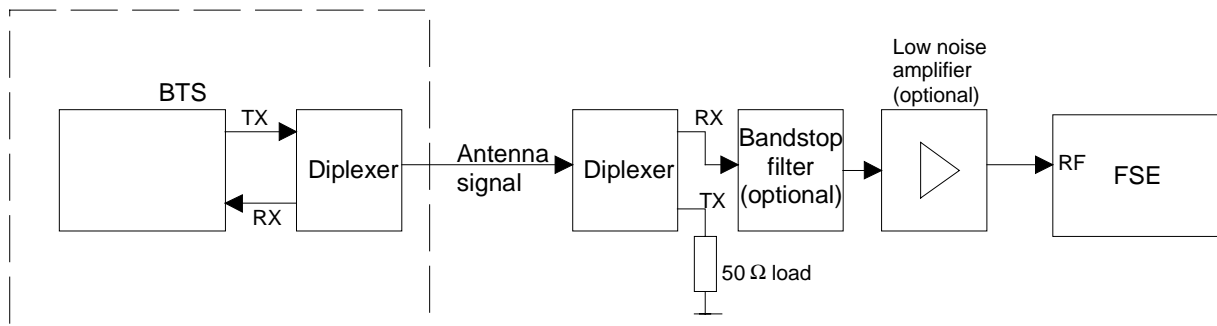

Test setup for BTS with separate RX input / TX output:

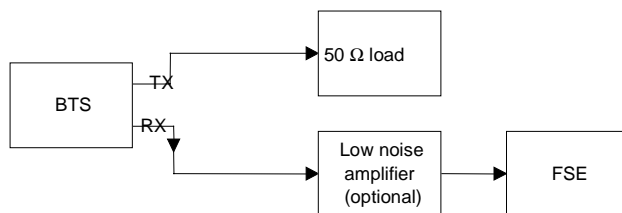

Menu: *CONFIGURATION MODE - GSM BTS ANALYZER - MODULATION SPECTRUM*

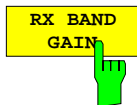

The *RX BAND GAIN* softkey is for defining the gain of an external preamplifier (or, in case of negative values, the insertion loss of a diplexer and bandstop filter connected ahead of the analyzer), which is then taken into account in the FSE/FSIQ display. A preamplifier is normally not needed. The attenuation of an external attenuator entered under *SETTING* is ignored in RX band measurements.

3.7.3 Additional Information

SigPwr	(Expected) signal power, defined by current settings for the power class and power control level
MeasPwr	Measured signal power
CorrPwr	Measured signal power, corrected by a value depending on the bandwidth (30 kHz RBW: +8dB)
MaxPwr	Maximum (nominal) output power of DUT
F(ARFCN)	Operating frequency determined by the frequency setting
TxSup	20 dB or 0 dB are taken into account in calculations depending on whether TX suppression is set to ON or OFF
ExtAtt	External attenuation
RxGain	RX band gain
SFH	SFH (slow frequency hopping) factor: 1 for SFH OFF, 3 for SFH ON
NOB	Number of bursts – value set by the user for the number of sweeps

The MOD measurement is implemented as a zero span measurement for Phase I and as a gated sweep measurement for Phases II and II+. So, different settings are required for the different standards and phases.

The measurement is performed over 50% to 90% of the burst, excluding the midamble, for a duration of approx. 170 μ s (46 bits).

The measurement section is defined by means of the trigger delay and sweep time in the zero span mode and by gate settings (gate delay and gate length) in the frequency scan mode.

The other GATE settings are taken from the trigger settings (level, mode, polarity, delay, length).

Note: *MOD measurements always require an external trigger !*

Absolute limits are defined for the RX band. Therefore, no pre-measurements are needed for the RX band.

TX band measurements fall into measurements directly at the carrier (at ± 1.8 MHz from the carrier, *ARFCN ± 1.8 MHz*) and measurements in the remaining TX band (*TX BAND*). The limit values for TX band measurements are defined on the basis of a reference power on the carrier determined during the pre-measurement. The limit values further depend on the BTS type and the actual output power.

The actual output power, which serves as a selection criterion for the limit values, is also determined in the pre-measurement. A bandwidth correction value is added to the power value determined in the pre-measurement to compensate for the difference resulting from the measurement of the carrier power with a filter bandwidth of 30 kHz instead of "at least 300 kHz", which is also possible. The correction value is 8 dB (in approximation to GSM 05.50).

The standards define limit values only for offsets <1800 kHz.

Therefore, the 1600 kHz offset value is also used for the 1800 kHz offset in ± 1.8 MHz measurements.

The limit value for offset = 1.8 MHz specified by the standards is used only for TX band measurements. The larger bandwidth required for TX band measurements is also taken into account.

So, the following levels are defined in MOD measurements:

- RefPwr Reference value for relative limit values, measured on the carrier with 30 kHz filter bandwidth
- CorrPwr Output power, here defined as '(RefPwr + 8.0) dBm', as a selection criterion for limit lines

Gated sweep and gate settings: Frequency sweeps must be gated. The gate settings are derived from the trigger settings and have the same values as the trigger settings:

- Gate Source *EXTERN* trigger source
- Gate Delay Corresponding to trigger delay (340.0 μ s referred to center of burst, bit transition 13/14)
- Gate Length Corresponding to sweep time of zero span (170.0 μ s)
- Gate Level Corresponding to trigger level (default setting: 1.4 V)
- Gate Polarity Corresponding to trigger polarity (default setting: *POSITIVE*)

EDGE is used as gate mode. It cannot be modified by the user.

Settings on opening the menu: The table display is active as usual. Since varied settings are required in the following depending on the selected type of measurement, no settings specific to MOD measurements are made except for the level settings.

The level settings are the same as on opening the TRA menu (see relevant section).

For band measurements the following applies:

Start of measurement: LIST mode: Switchover to split-screen display
 Screen A: display of (intermediate) results
 Screen B: trace measurement and display
 With SINGLE/CONT, full-screen display is maintained; the measurement is performed as a frequency sweep with a trace.

3.7.3.1 RX Band Measurements

Defined only for PGSM-I and DCS-I.

Note: *The use of a diplexer or suitable notch filter is assumed for RX band measurements. RX band measurements are carried out with high sensitivity !*

Settings: LIST mode:
 InpAtt 0 dB
 RefLvl -40 dBm
 Trace 1 BLANK
 Trace 2 AVERAGE Sample
 Trace 3 BLANK
 Trace 4 BLANK
 RBW/VBW 100 kHz / 100 kHz
 Zero Span, Step 200 kHz
 FrequRange RX band
 SweepTime 170.0 μ s
 TriggerDelay 340.0 μ s

SINGLE/CONT mode:
 FrequencyScan, SingleSweep
 FreqRange RX band
 InpAtt 0 dB
 RefLvl -40 dBm
 Trace 1 AVERAGE Sample
 Trace 2 BLANK
 Trace 3 BLANK
 Trace 4 BLANK
 RBW/VBW 100 kHz / 100 kHz
 SweepTime 75 ms
 Gated Sweep ON

3.7.3.2 Pre-Measurement

Pre-measurement with split-screen or full-screen display depending on mode (LIST or SINGLE/CONT). Either trace 2 or trace 1 is active. Otherwise the settings are the same in both cases.

Settings: SingleSweep, ZeroSpan; Center = F(ARFCN)

RBW/VBW 30 kHz / 30 kHz
 TriggerDelay 340.0 μ s
 SweepTime 170.0 μ s
 InpAtt MAX (INT ((SigPwr + 3 - ExtAtt + 19.99) / 10) * 10, 0)
 RefLvl 3.0 + SigPwr
 Display Y axis LOG_100 dB
 MaxLvl Coupled to RefLvl
 Trace 1/2 BLANK
 Trace 2/1 AVERAGE Sample
 Trace 3 BLANK
 Trace 4 BLANK

The pre-measurement procedure is the same for ± 1.8 MHz and TX BAND measurements.

3.7.3.3 Main Measurement

a) ARFCN ± 1.8 MHz Measurement – Range Close to Carrier

LIST mode: The measurement is performed in the zero-span mode at the frequency points specified by the standard.
 $\delta f = \pm 100, 200, 250, 400, 600, 800, 1000, 1200, 1400, 1600, 1800$ kHz offset from F(ARFCN)

Further settings:

SingleSweep	
RBW/VBW	30 kHz / 30 kHz
TriggerDelay	340.0 μ s
SweepTime	170.0 μ s
InpAtt	MAX (INT ((CorrPwr - ExtAtt + 19.99) / 10) * 10, 0)
RefLvl	CorrPwr
Display	Y axis LOG_100 dB
MaxLvl	Coupled to RefLvl
Trace 1	BLANK
Trace 2	AVERAGE Sample
Trace 3	BLANK
Trace 4	BLANK
PLL	YIG_CTRL_LOOP_LOW

SINGLE/CONT mode: The measurement is performed as a gated frequency sweep across the range close to the carrier.

FrequencyScan, SingleSweep	
FrequSpan	3.6 MHz
Center	F(ARFCN)
RBW/VBW	30 kHz / 30 kHz
InpAtt	MAX (INT ((CorrPwr - ExtAtt + 19.99) / 10) * 10, 0)
RefLvl	CorrPwr
Trace 1	AVERAGE Sample
Trace 2	BLANK
Trace 3	BLANK
Trace 4	BLANK
SweepTime	75 ms
PLL	YIG_CTRL_LOOP_LOW
Gated Sweep	ON

b) TX Band Measurement – TX Band Excluding Range Close to Carrier

LIST mode,
DCS1800 Phase I: The measurement is performed in the zero span mode at the frequency points specified by the standard (every 200 kHz, starting at the lower limit of the TX band). The TX band is divided into four ranges:
 $T_{x,Low}$ to $F(a)-6.0$, $F(a)-6.0$ to $F(a)-1.8$, $F(a)+1.8$ to $F(a)+6.0$, $F(a)+6.0$ to $T_{x,High}$ [MHz], where $F(a)$ is the ARFCN frequency. This is because different limits are specified for these ranges.

Further settings:

SingleSweep	
RBW/VBW	100 kHz / 100 kHz
TriggerDelay	340.0 μ s
SweepTime	170.0 μ s
InpAtt	MAX (INT ((CorrPwr - 15 - ExtAtt + 19.99) / 10) * 10, 0)
RefLvl	CorrPwr - 15.0
Display	Y axis LOG_100 dB
MaxLvl	Coupled to RefLvl
Trace 1	BLANK
Trace 2	AVERAGE Sample
Trace 3	BLANK
Trace 4	BLANK

LIST mode,
other standards
(Phase II and
subsequent standards):

The measurement is performed as a frequency sweep.
The TX band is divided into four ranges:
Tx_{Low} to F(a)-6.0, F(a)-6.0 to F(a)-1.8, F(a)+1.8 to F(a)+6.0, F(a)+6.0 to Tx_{High}
[MHz], where F(a) is the ARFCN frequency. This is because different limits are
specified for these ranges.

Further settings:

SingleSweep	
RBW/VBW	100 kHz / 100 kHz
InpAtt	MAX (INT ((CorrPwr - 15 - ExtAtt + 19.99) / 10) * 10, 0)
RefLvl	CorrPwr - 15.0
Display	Y axis LOG_100 dB
MaxLvl	Coupled to RefLvl
Trace 1	BLANK
Trace 2	AVERAGE Sample
Trace 3	BLANK
Trace 4	BLANK
SweepTime	75 ms
Gated Sweep	ON

SINGLE/CONT mode: The measurement is performed as a gated frequency sweep across the
complete range.

FrequencyScan, SingleSweep	
FrequSpan	TX band
RBW/VBW	100 kHz / 100 kHz
InpAtt	MAX (INT ((CorrPwr - 15 - ExtAtt + 19.99) / 10) * 10, 0)
RefLvl	CorrPwr - 15.0
Trace 1	AVERAGE Sample
Trace 2	BLANK
Trace 3	BLANK
Trace 4	BLANK
SweepTime	75 ms
Gated Sweep	ON

Note: *This measurement is in line with standards only outside the range close to the carrier because a uniform bandwidth of 100 kHz is used also across the carrier (the measurement is therefore more accurate within the range ARFCN ± 1.8 MHz).*

If the TX GATE ON/OFF softkey is set to OFF, measurements are performed over the entire frame! The trigger/gate settings are not needed in this case since the FreeRun trigger mode is active.

c) TX Band Measurement – Complete TX Band

In this measurement, the two above-described LIST measurements are performed one after the other.

3.7.3.4 Limit Lines – Selection, Base Lines, Values

For the RX band, fixed and absolute values are specified.

For the TX band, relative limit lines are specified whose characteristics depends on BTS types and signal powers.

Selection of basic characteristic: 8 dB is added to the power measured in the pre-measurement, and the resulting value is rounded to whole dBm. The result is used for selecting the limit line characteristics. Linear interpolation of the limit lines, which is specified by the standards, is effected by /FSIQ in 1 dB steps yielding 1 dB interpolation resolution.

Based on the pre-measurement, the relative limit line values are scaled to yield absolute values. Scaling takes into account the base lines specified by the standards, so that limit lines are clipped especially when low signal powers are measured. Base lines depend on standards, phases and BTS types (see GSM standards).

3.7.3.5 Exceptions

Standards provide for the following exceptions down to a level of max. -36 dBm:

Std/Phase	≤6MHz	>6 MHz offset
P-GSM-I	None	None
X-GSM, DCS-II, PCS	3 from 600 kHz	12
DCS-I	3 (0.8 kHz to 6 MHz)	12

3.8 Measurement of Spectrum due to Transients

The spectrum due to transients is defined as the spectrum produced by modulation of the carrier and by switching operations of the burst signal.

FSE/FSIQ offers two modes for measuring the spectrum due to transients:

- Overview measurement in frequency domain (*TRANSIENT SPECTRUM*)
- Output of measured values in tabular form (*TRANSIENT LIST*)

Menu: *CONFIGURATION MODE - GSM BTS ANALYZER*

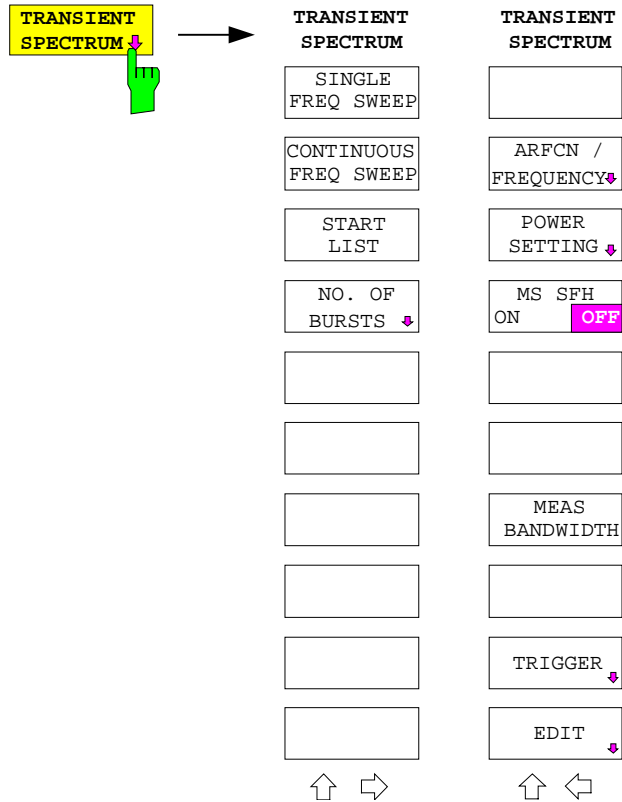

The *TRANSIENT SPECTRUM* softkey opens a submenu for configuring and starting the measurement of the spectrum due to transients.

The level peaks produced by the switching operations are measured using the max. peak detector and the max. hold function. The result obtained stems from the carrier modulation spectrum and the spectrum due to switching caused by the TDMA burst.

The spectral display of the spectrum due to transients includes the limit values which are dependent on the set power level.



The *SINGLE FREQ SWEEP* softkey starts a single measurement in the frequency domain.

The spectrum is displayed as a trace with limit values selected on the basis of the BTS output level (determined in the pre-measurement).

The sweep time is influenced by the value entered under *NO. OF BURSTS*. It is set so that each pixel contains the predefined number of bursts.

CONTINUOUS
FREQ SWEEP



The *CONTINUOUS FREQ SWEEP* softkey starts a continuous measurement with the trace being rewritten for each sweep. The peak detector is used for this measurement. The sweep time is influenced by the value entered under *NO. OF BURSTS*. It is set so that each pixel contains the predefined number of bursts.

The display of the spectrum due to transients includes the limit values which are dependent on the set power level.

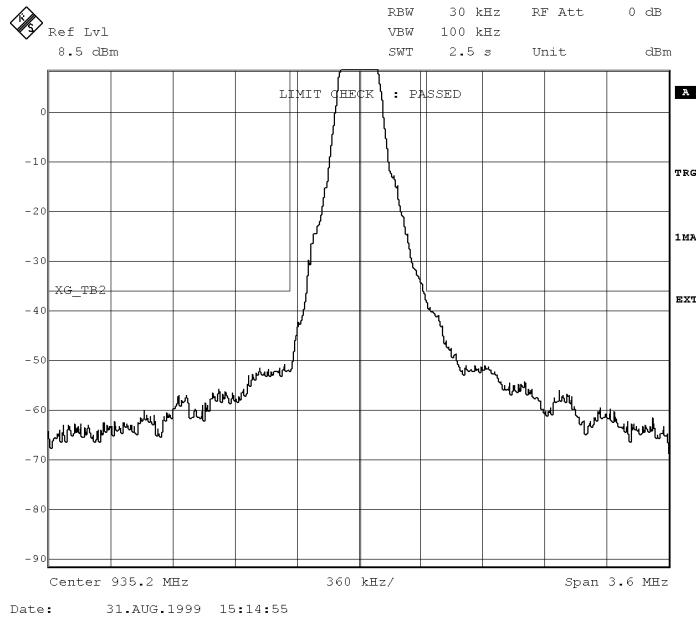

Fig. 3-20 Measurement of the spectrum due to transients of a GSM base station in the frequency domain. The limit lines as well as the PASSED/FAILED information are displayed.

NO. OF
BURSTS



NO. OF BURSTS

SET MANUAL

SET TO STANDARD

The *NO. OF BURSTS* softkey opens a submenu for defining the number of bursts to be taken into account in the measurement.

The *SET MANUAL* softkey opens a window for entering a user-defined number of bursts. The default setting is 1 burst.

The *SET TO STANDARD* softkey sets the number of bursts in accordance with the selected standard and the selected band.

At each frequency offset a number of measurements as defined by the *NO. OF BURSTS* is performed . A maximum of 2000 bursts can be measured.

The number of bursts can be reduced to increase measurement speed.

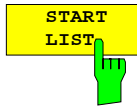

The *START LIST* softkey starts measurement of the spectrum due to transients at the carrier offsets ± 400 kHz, ± 600 kHz, ± 1200 kHz and ± 1800 kHz. The results are displayed in tabular form together with the limit values.

Adjacent-channel power is measured in the zero span mode at the above-named offsets from the set channel frequency.

The preset carrier power and the powers measured at the offsets are displayed numerically.

An external trigger signal is used.

Tabular display of spectrum due to transients:

The limit values shown in the second column from the right are derived from the limit line which is dependent on the selected power level. If limit values are exceeded, they are marked "FAILED", otherwise "PASSED". The measured value exceeding the limit is marked by an asterisk (*).

Measured values exceeding the relative limit value are output as absolute levels in dBm.

P-GSM 900 II		TRANSIENT SPECTRUM LIST			
ARFCN:	1	Status:		PASSED	
Frequency:	935.20000 MHz	Ext Atten:		20.0 dB	
Carrier Power:	20.0 dBm	No of Bursts:		1	
Ref Pwr (RBW 300 kHz)	18.62 dBm				
No.:	Offset Freq.	+Offset	-Offset	Limit	Status
	400 kHz	-37.7 dBm	-51.4 dBm	-36.0 dBm	PASSED
	600 kHz	-52.3 dBm	-53.0 dBm	-36.0 dBm	PASSED
	1200 kHz	-57.4 dBm	-62.9 dBm	-36.0 dBm	PASSED
	1800 kHz	-66.1 dBm	-64.5 dBm	-36.0 dBm	PASSED

Fig. 3-21 Measurement of the spectrum due to transients in the zero span mode and output in tabular form. The table shows measured values, limit values and the PASSED/FAILED information for the offset frequencies stipulated by standards as well as a summary PASSED/FAILED information.

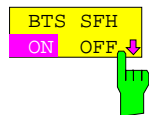

With the *BTS SFH ON/OFF* softkey it can be selected if the analyzer is to take into account SFH of the BTS or not.

If SFH is switched on, the sweep time is tripled.

It is assumed that frequency hopping is between channels B, M and T as stipulated by the standard.

So the measurement can be performed during the complete time without any disturbance being caused when the carrier is not at the set ARFCN.

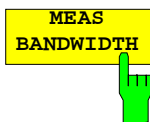

The *MEAS BANDWIDTH* softkey opens a table for selecting the FSE/FSIQ bandwidth for this measurement. The table offers discrete values as well as the STANDARD setting (measurement bandwidth in compliance with standard).

3.8.1 Additional Information

Abbreviations used:

SigPwr	(Expected) signal power, defined by current settings for the power class and power control level
MeasPwr	Measured signal power
F(ARFCN)	Operating frequency determined by the frequency setting
SFH	SFH (slow frequency hopping) factor: 1 for SFH OFF, 3 for SFH ON
NOB	Number of bursts – value set by the user for the number of sweeps

Settings on opening the menu:

Full-screen with result table
 Full screen (A) – display of table (LIST mode - result display ON)
 Setting of trace display window (screen B):
 ZeroSpan, SingleSweep; CenterFrequ = F(ARFCN)

InpAtt	MAX (INT ((SigPwr + 3 - ExtAtt + 19.99) / 10) * 10, 0)
RefLvl	3.0 + SigPwr
Trace 1:	BLANK
Trace 2:	MAX/HOLD Peak
Trace 3:	BLANK
Trace 4:	BLANK

Start of measurement:

LIST mode
 Switchover to split screen:
 Screen A: display of (intermediate) results
 Screen B: display of trace
 In the SINGLE/CONT modes, full-screen display is maintained; the measurement is performed as a frequency sweep with a trace being displayed.

Pre-measurement:

Split screen or full screen, depending on mode (LIST or SGL/CONT). Either trace 2 or trace 1 is active.
 The settings are otherwise the same in both cases.
 SingleSweep, Zerospan; Center = F(ARFCN)

RBW/VBW	300 kHz / 1MHz (standard) or user-selected (300 kHz / 1 MHz or 1 MHz / 3 MHz)
TriggerDelay:	TrgOffset
InpAtt	MAX (INT ((SigPwr + 3 - ExtAtt + 19.99) / 10) * 10, 0)
RefLvl	3.0 + SigPwr
Display	Y axis LOG_100 dB
MaxLvl	Coupled to RefLvl
SweepTime:	5 ms * SFH factor (=3)
Trace ½:	BLANK
Trace 2/1:	MAX/HOLD Peak
Trace 3:	BLANK
Trace 4:	BLANK

Main
measurement:

SINGLE/CONT:	Span = 3.6 MHz; Center = F(ARFCN)	
LIST:	ZeroSpan, Center = F(ARFCN)	
RBW/VBW	30 kHz / 100 kHz	
InpAtt	MAX (INT ((MeasPwr - 15 - ExtAtt + 19.99) / 10) * 10, 0)	
RefLvl	MeasPwr - 15.0	
Display:	Y axis LOG_100 dB	
MaxLvl	Coupled to RefLvl	
SweepTime	2.5 s * SFH factor (=3)	(SINGLE/CONT)
	5 ms * SFH factor (=3)	(LIST)
PLL	YIG_CTRL_LOOP_LOW	
Trace 1/2:	BLANK	
Trace 2/1:	MAX/HO Peak LD	
Trace 3:	BLANK	
Trace 4:	BLANK	
Test points:	+/- 400, 600, 1200, 1800 kHz; (LIST)	

3.9 Measurement of Spurious Emissions

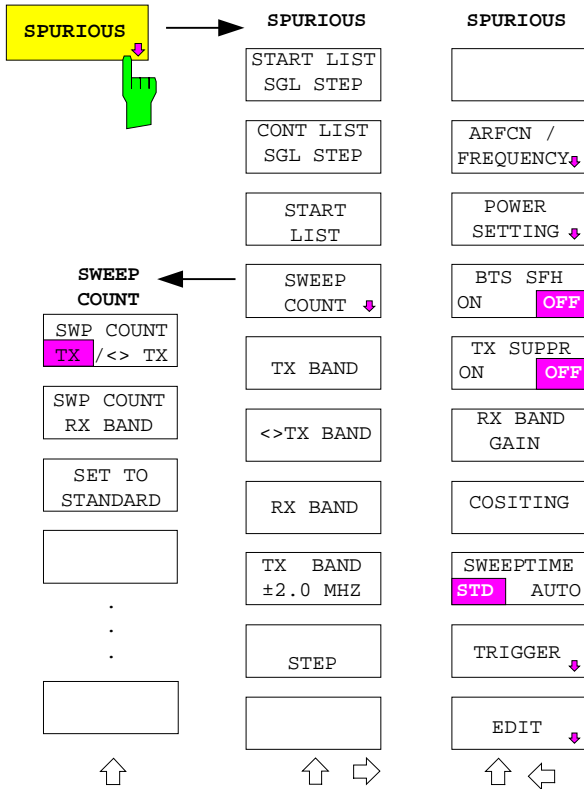

The *SPURIOUS* softkey opens a submenu for configuring and starting the measurement of spurious emissions.

The standards specify measurements in various frequency bands with different bandwidth settings.

The *TX BAND*, *<>TX BAND* and *RX BAND* softkeys are for selecting the frequency range for the measurement.

Different test setups are required for the different bands.

It is possible to measure when SFH is active. It is assumed that the effect of the hopping carrier is negligible at that distance from the hopping carrier at which the strength of the spurious emission is of interest.

The measurement time is tripled if SFH = ON.

If adequate suppression of the TX band is ensured, the sensitivity of the instrument can be increased by approx. 20 dB with the *TX SUPPR ON/OFF* softkey.

For a fast overview measurement, a measurement time much shorter than that stipulated in the standards can be selected (*SWEPTIME STD/AUTO*).

The *SELECT STEP* softkey is for selecting the band sections to be measured (of the band to be tested in accordance with standards).



The *START LIST SGL STEP* softkey starts a step-by-step measurement across the sections selected by means of *SELECT STEP* at the bandwidths stipulated by the standard.

The single-step mode is of advantage where a detailed test report has to be created, for example.



With the *CONT SGL STEP LIST* softkey, the measurement is continued with the next band section in each case (compare *SELECT STEP*).

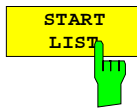

The *START LIST* softkey starts a single measurement sequence across all sections selected by means of *SELECT STEP* at the bandwidths stipulated by the standard.

The display automatically switches to the split-screen mode. The upper window shows a list of spurious emissions, the lower window the spectrum of the current sweep. If the limit value and the margin are not exceeded, the range in question is evaluated *PASSED*.

If the measured values are within the margin, the values are evaluated *MARGIN*. If the limit value is exceeded, *FAILED* is indicated.

A new measurement can be started by pressing the *START LIST* softkey again.

After completion of the measurement, FSE/FSIQ switches to full-screen display. The list of spurious emissions is displayed.

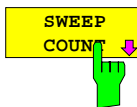

The *SWEEP COUNT* softkey opens a submenu for selecting the number of sweeps over which the average is formed in the RX band and the peak values are measured within and outside the TX band.

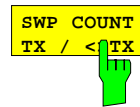

The *SWP COUNT TX / <TX (Non TX)* softkey allows manual entry of the number of sweeps over which the peak values are measured within and outside the TX band.

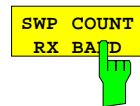

The *SWP COUNT RX BAND* softkey opens a window for entering the number of sweeps over which the average is formed in RX band measurements.



The *SET TO STANDARD* softkey sets the number of sweeps to the value specified by the relevant standard.

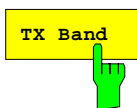

The *TX BAND* softkey selects the transmit band of the base station for measuring spurious emissions.

Measurements in the TX band can generally be carried out with FSE/FSIQ alone, requiring no additional equipment (except for BTS with a very high power, ie > 46 dBm).

For BTS > 46 dBm, the same test setup as for <> TX BAND is required.

Test setup for TX BAND measurements:

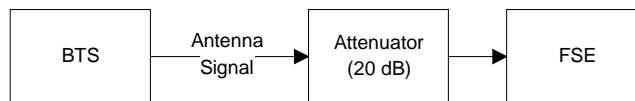

Output of spurious list:

TX BAND:

P-GSM 900 II		SPURIOUS LIST		TX Band	
ARFCN: 1		Status: FAILED			
Frequency: 935.20000 MHz		Ext Atten: 20.0 dB			
Carrier Power: 20.0 dBm					
No.	Frequency	Level	Limit	Status	
	937.00000 MHz --- 941.20000 MHz	-60.3 dBm	-36 dBm	PASSED	
	941.20000 MHz --- 960.00000 MHz	-19.1 dBm	-36 dBm	>FAILED<	
1	950.09138 MHz	-19.1 dBm	-36 dBm	>FAILED<	
2	949.82766 MHz	-20.2 dBm	-36 dBm	>FAILED<	
3	949.18717 MHz	-23.5 dBm	-36 dBm	>FAILED<	
4	948.54669 MHz	-28.0 dBm	-36 dBm	>FAILED<	
5	948.81042 MHz	-28.7 dBm	-36 dBm	>FAILED<	
6	947.75551 MHz	-30.6 dBm	-36 dBm	>FAILED<	

EXT

Fig. 3-22 Example of spurious list

The upper part of the list indicates the current TX channel (ARFCN), the carrier power, the currently measured frequency and a summary status of the measurement (PASSED/ FAILED/ ABORTED/ BLANK).

A summary entry is shown for each frequency range measured. This entry comprises the frequency limits, the maximum level measured, and the summarized result of the limit check. If spurious emissions are found in a frequency range, the single frequencies at which they have occurred are listed in addition in separate lines below the summary entry. (Definition of frequency range: same bandwidth setting of FSE and same limit value.)

In the *Limit* column the limit values in accordance with the selected standard are displayed. If a limit value is exceeded, *FAILED* is indicated, otherwise *PASSED*. If a measured value is below the limit value by less than the set margin, *MARGIN* is indicated.

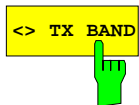

The <>TX BAND softkey activates the measurement of spurious outside the transmit band.

For BTS of average power or higher (> 35 dBm), measurements outside the TX band (<> TX BAND) require the use of a bandstop filter to suppress the carrier(s) and thus obtain the necessary dynamic range.

The bandstop filter should suppress the carrier by min. 20 dB. The sensitivity of FSE/FSIQ can then be increased by 20 dB by pressing the TX SUPPR ON softkey.

Test setup for <> TX BAND measurements:

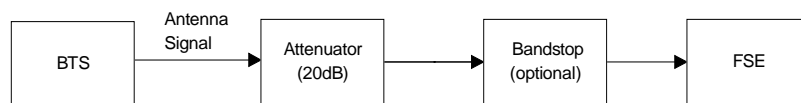

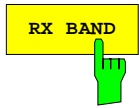

The *RX BAND* softkey selects the RX band for measuring the spurious emissions of the base station.

The stringent specifications for spurious measurements in the RX band make it absolutely necessary for BTS with combined RX input / TX output to provide sufficient suppression of the carrier signal(s) (max. carrier level <-10 dBm at FSE/FSIQ input), for example by means of bandstop filters or diplexers. The more stringent demands for GSM Phase 1 in addition call for an external low-noise preamplifier if FSEB or FSEM is used, which have an input noise higher than that of FSEA.

For BTS with a separate RX input, the TX channel is always sufficiently suppressed at the RX input.

With *RX BAND* selected, FSE/FSIQ is set to 0 dB attenuation to achieve maximum sensitivity.

The *RX BAND GAIN* softkey allows the gain of an external preamplifier to be entered, which is taken into account in the FSE/FSIQ display.

The attenuation of an external attenuator entered under *SETTING* is ignored in RX band measurements.

Caution: *The level of +20 dBm at the FSE/FSIQ input must in no case be exceeded with 0 dB attenuation of the input attenuator.*

A warning to this effect is output when the *RX BAND* softkey is activated:

Caution:

Connect bandpass or bandstop to suppress TX band!

Test setup for BTS with combined RX input / TX output:

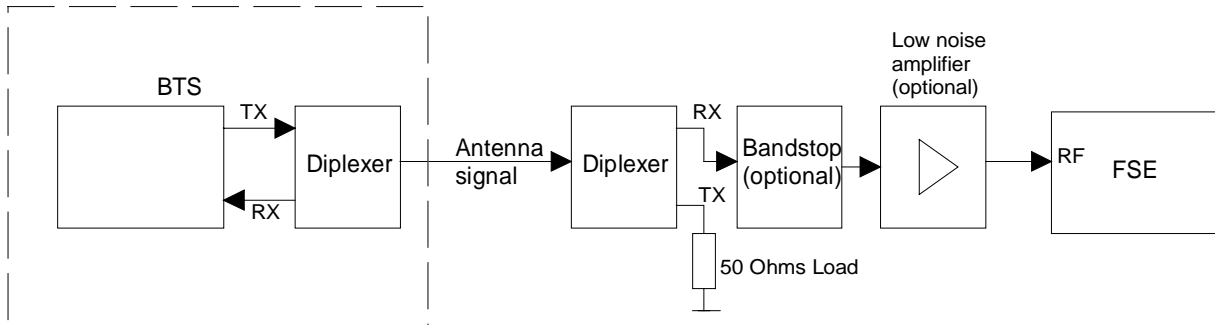

Test setup for BTS with separate RX input / TX output:

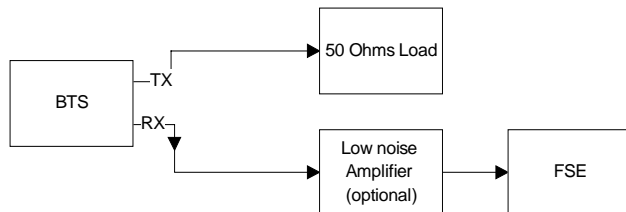

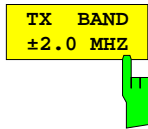

The *TX BAND ±2.0 MHz* softkey selects the BTS transmit band plus ±2 MHz for measuring spurious emissions.

Thus the characteristics of a carrier close to the band limit, too, can be measured and compared with the TX limit values. The settings correspond to those of the TX band except for the band extension.

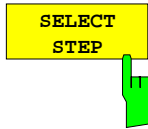

The *SELECT STEP* softkey opens a list of predefined band sections from which the section(s) to be measured can be selected. The default setting is the complete frequency range specified by the standard for the selected band.

Band sections can be selected and activated/deactivated by means of the spinwheel, the cursor keys and the unit keys (ENTER).

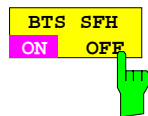

The *BTS SFH ON/OFF* softkey sets FSE/FSIQ so that slow frequency hopping of the BTS is taken into account in TX band measurements (status ON).

Frequency hopping is between channels B, M and T. Channels B and T are fixed at the limits of the TX band, whereas channel M can be selected by means of the *ARFCN* softkey in the *BTS TEST SETTINGS* menu. The three channels are skipped in spurious emission measurements in the TX band. If SFH is switched on, the sweep time is tripled.

It is thus ensured that the desired number of bursts of the ARFCN to be measured is taken into account.

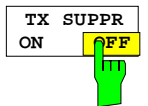

The *TX SUPPR ON/OFF* softkey is for activating/deactivating higher sensitivity.

The sensitivity of FSE/FSIQ can be increased by means of a bandstop filter for carrier suppression. The bandstop filter should be selected so that the carrier is suppressed by at least 20 dB. The sensitivity of FSE/FSIQ can then be increased by 20 dB by means of *TX SUPPR ON*.



The *RX BAND GAIN* softkey opens a window for entering the gain of an external preamplifier (or, in the case of negative values, the insertion loss of a diplexer and bandstop filter connected ahead of the analyzer), which is taken into account in the FSE/FSIQ display. A preamplifier is normally not needed.

The attenuation of an external attenuator entered under *SETTING* is ignored in RX band measurements.



The *COSITING GSM/DCS* softkey selects the RX band also of the other standard for Phase II measurements.

For DCS/Phase II and GSM Phase II, the *RX BAND* softkey causes a measurement to be performed not only in the RX band(s) but also in the TX band of the other standard in accordance with standard stipulations.

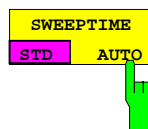

The *SWEPTIME STD/AUTO* softkey is for selecting the measurement time in accordance with the standard (STD) or the maximum possible measurement time of FSE/FSIQ. For *AUTO*, all slots of the frame should be active.

3.9.1 Additional Information

Settings on opening the menu / start of measurement: Full-screen display of result table of (previously) selected band
 Switchover to split-screen:
 Screen A: display of (intermediate) results
 Screen B: display of trace
 In single-step operation, the markers are available for measurements after each step.

The following settings are relevant:

TxSup TX suppression
 When ON is selected, a value of 20 dB is taken into account in the formulas for calculating the input attenuation and the reference level.
 Cositing Relevant to RX band measurements, see description given there.
 SFH Slow frequency hopping. For sweep time calculation see below.
 STD Standard/Auto sweep time. For sweep time calculation see below.

Setting and calculation of sweep time (all times in μ s):

TX, <> TX: $swptime = (SPAN/RBW) * 577 * <sfh> * <std>$
 or
 $swptime = 500 * 577 * <sfh> * <std>$, if $(SPAN/RBW) < 500$
 where
 $<sfh> = 3$ if SFH==ON, otherwise 1
 $<std> = 8$ if STD==ON, otherwise 1 (with AUTO sweep time)
 If the result is below 2.5 s, it is rounded up to the next highest whole tenth of a second.
 RX: ZeroSpan (Phase I) or fixed at 75 ms (Phase II P-GSM and DCS, E-GSM, R-GSM, PCS)
 If the result for Phase I is below 75 ms, it is set to 75 ms.
Important: For SFH=ON, a factor of 3 applies also in this case !

Settings on opening the menu: Full-screen display of table of (previously) selected band.
 All traces BLANK, trace 2 at Peak/MaxHold
 Trace 1: BLANK
 Trace 2: MAX/HOLD Peak
 Trace 3: BLANK
 Trace 4: BLANK
 PLL-BW: YIG-CTRL-LOOP AUTO
InpAtt: $MAX (INT ((SigPwr - 15 - TxSup - ExtAtt + 19.99) / 10) * 10, 0)$
RefLevel: $SigPwr - 15 - TxSup$

Example: $InpAtt = MAX (INT ((46 - 15 - 0 - 20 + 19.99) / 10) * 10, 0) = MAX (30, 0) = 30$ [dB].
 $RefLvl = 46 - 15 = 31$ [dBm]

TX band RBW/VBW Variable (depending on carrier offset as per standard specification)
 InpAtt Same as on opening the menu
 RefLvl Same as on opening the menu
 SweepTime: See above

TX sections: Delta F [MHz] RBW/VBW [kHz] Sweep time
 0.6 to 1.8 10 / 30 2.4 s (Phase I only)
 1.8 to 6.0 30 / 100 2.4 s
 >6.0 100 / 300 2.4 s

RX band	InpAtt	0 dB	
	RefLvl	-20 – TxSup	
	RBW/VBW	30 kHz / 100 kHz	Phase I PGSM
		100 kHz / 100 kHz	Phase II PGSM; DCS; EGSM / RGSM / PCS
	Trace 2:	Average	Sample
	SweepTime:	AUTO	Phase I PGSM/DCS (75 ms, see above)
	75 ms	Phase II PGSM; EGSM / RGSM / PCS	

Important: When the RX band is selected, TX SUPPR is automatically set to ON. TX SUPPR must be set to OFF if the conditions for a measurement with high sensitivity are not fulfilled.

Frequency sections:	Only RX band of selected standard (MHz)	For PGSM-I and DCS-I (RBW/VBW = 30/100 kHz):
	890 to 915	PGSM-I
	1710 to 1785	DCS-I
	890 to 915	PGSM-II
	1805 to 1880	
	890 to 915	PGSM-II cositing
	1710 to 1785	
	1805 to 1880	
	925 to 960	DCS-II
	1710 to 1785	
	921 to 960	DCS-II+
	1710 to 1785	
Additionally:	880 to 915	DCS-II and DCS-II+, cositing
	876 to 915	
	1850 to 1910	PCS
TX band	RBW/VBW	Variable (depending on frequency range as per standard specification)
	InpAtt	Same as on opening the menu
	RefLvl	Same as on opening the menu
	SweepTime:	See above
	PLL BW:	LOW for all frequency sections in part or completely below 10 MHz

TX sections (X-GSM, DCS-II, PCS):	Frequency range	RBW/VBW [kHz]	Sweep time (s)
	100 kHz to 30 MHz	10/30	14.0
	30 MHz to 50 MHz	10/30	9.0
	50 MHz to 500 MHz	100/300	21.0
	500 MHz to Tx -30 MHz	3000/3000	2.4
	Tx -30 MHz to Tx -20 MHz	1000/3000	2.4
	Tx -20 MHz to Tx -10 MHz	300/1000	2.4
	Tx -10 MHz to Tx -5 MHz	100/300	2.4
	Tx -5 MHz to Tx -2 MHz	30/100	2.4
	Tx +2 MHz to Tx +5 MHz	30/100	2.4
	Tx +5 MHz to Tx +10 MHz	100/300	2.4
	Tx+10MHz to Tx+20MHz	300/1000	2.4
	Tx+20MHz to Tx+30MHz	1000/3000	2.4
	Tx+30MHz to 4 GHz	3000/3000	4.7
	4 GHz to 12.75 GHz	3000/3000	13.5

PGSM-I; DCS analog	Frequency range	RBW/VBW [kHz]	Sweep time (s)
	9 kHz to 100 kHz	1/3	2.4
	100 kHz to 10 MHz	10/30	4.6
	10 MHz to 30 MHz	1000/3000	2.4
	30 MHz to 890 MHz	3000/3000	2.4
/* RX band interval*/	915 MHz to 925 MHz	300/1000	2.4
	925 MHz to 930 MHz	100/300	2.4
	930 MHz to 933 MHz	30/100	2.4
/* TX band interval*/	962 MHz to 965 MHz	30/100	2.4
	965 MHz to 970 MHz	100/300	2.4
	970 MHz to 980 MHz	300/1000	2.4
	980 MHz to 990 MHz	1000/3000	2.4
	990 MHz to 4 GHz	3000/3000	4.7
	4 GHz to 12.75 GHz	3000/300	13.5

For the FSE analyzers (FSEA/B/M), the values for the sweep time for STD and AUTO are listed under *SELECT STEP*.

4 Remote Control

The following chapter is intended to supplement and update chapter 3, section 3.6 and 3.9 of the operating manual for the basic instrument. It contains the commands for options GSM BTS Analyzer (FSE-K11) and GSM MS Analyzer (FSE-K10).

4.1 Description of Commands

4.1.1 CALCulate Subsystem

4.1.1.1 CALCulate:LIMit Subsystem

The CALCulate:LIMit subsystem comprises the limit lines and the corresponding limit checks.

COMMAND	PARAMETERS	UNIT	COMMENT
CALCulate			
:LIMit<1 to 8>			Option FSE-K11 or FSE-K10
:BURSt	--		
:PTEMplate?			query only
:POWer?	--		query only
:SPEctrum	--		
:MODulation?	ARFCn TXBand RXBand COMBined DCSRx1800		query only
:FAILs?	ARFCn TXBand RXBand COMBined DCSRx1800		query only
:EXCeptions?	ARFCn TXBand RXBand COMBined DCSRx1800		query only
:SWITChing?			query only
:FAILs?			query only
:SPURious?	TXBand OTXBand RXBand IDLeband	DB	query only
:FAILs?	TXBand OTXBand RXBand IDLeband		query only
:MARGin	<numeric_value>	DB; DB	

CALCulate<1|2>:LIMit<1 to 8>:BURSt:PTEMplate?

This command queries the result of the limit check for a power vs. time measurement.

Parameter: The result is displayed in character data form. Possible values are:
 PASSED limit not exceeded
 FAILED limit exceeded
 RUNNING measurement not completed

Examples: "CALC:LIM:BURS:PTEM?"

Features: *RST value: --
 SCPI: device-specific

Modes: BTS, MS

This command is a query and therefore not assigned a *RST value.

If no measurement has been carried out yet, a query error is triggered off. The numeric suffixes <1|2> or <1 to 8> are not significant for this command.

CALCulate<1|2>:LIMit<1 to 8>:BURSt:POWer?

This command queries the total result of the carrier power measurement.

Parameter: The result is displayed in character data form. Possible values are:
 PASSED limit not exceeded
 FAILED limit exceeded
 ABORTED measurement aborted
 RUNNING measurement not completed

Examples: "CALC:LIM:BURS:POW?"
 Result: PASSED

Features: *RST value: --
 SCPI: device-specific

Modes: BTS, MS

This command is a query and therefore not assigned a *RST value.

If the command is triggered off before the carrier power measurement was started for the first time, a query error results. The numeric suffixes <1|2> or <1 to 8> are not significant for this command.

CALCulate<1|2>:LIMit<1 to 8>:SPECtrum:MODulation? ARFCn | TXBand | RXBand | COMBined | DCSRx1800

This command queries the total result of the spectrum due to modulation measurement.

Parameter: The result is displayed in character data form. Possible values are:
 PASSED limit not exceeded
 FAILED limit exceeded
 ABORTED measurement aborted
 RUNNING measurement not completed

Examples: "CALC:LIM:SPEC:MOD? RXB"
 Result: PASSED

Features: *RST value: --
 SCPI: device-specific

Modes: BTS, MS

ARFCn	ARFCN ± 1.8 MHz	TXBand	TX-band
RXBand	RX-band	COMBined	ARFCN ± 1.8 MHz / TX-band
DCSRx1800	RX-Band DCS 1800 (option FSE-K10 only)		

This command is a query and therefore not assigned a *RST value.

The numeric suffixes <1|2> or <1 to 8> are not significant for this command.

CALCulate<1|2>:LIMit<1 to 8>:SPECtrum:MODulation:FAILs? ARFCn | TXBand | RXBand | COMBined | DCSRx1800

This command queries the number of limit violations of the spectrum due to modulation measurement.

Examples: "CALC:LIM:SPEC:MOD:FAIL? RXB"

Features: *RST value: --
 SCPI: device-specific

Modes: BTS, MS

ARFCn	ARFCN ± 1.8 MHz	COMBined	ARFCN ± 1.8 MHz / TX-band
TXBand	TX-band	DCSRx1800	RX-Band DCS 1800 (option FSE-K10 only)
RXBand	RX-band		

This command is a query and therefore not assigned a *RST value The numeric suffixes <1|2> or <1 to 8> are not significant for this command.

CALCulate<1|2>:LIMit<1 to 8>:SPECtrum:MODulation:EXCeptions? ARFCn | TXBand | RXBand | COMBined | DCSRx1800

This command queries the number of limit violations of the spectrum due to modulation measurement which are marked as exceptions.

Examples: "CALC:LIM:SPEC:MOD:EXC? RXB"

Features: *RST value: --
SCPI: device-specific

Modes: BTS, MS

ARFCn	ARFCN ± 1.8 MHz	COMBined	ARFCN ± 1.8 MHz / TX-band
TXBand	TX-band	DCSRx1800	RX-Band DCS 1800 (option FSE-K10 only)
RXBand	RX-band		

This command is a query and therefore not assigned a *RST value. The numeric suffixes <1|2> or <1 to 8> are not significant for this command.

CALCulate<1|2>:LIMit<1 to 8>:SPECtrum:SWITching?

This command queries the total result of the spectrum due to switching transients measurements.

Parameter: The result is displayed in character data form. Possible values are:
PASSED limit not exceeded
FAILED limit exceeded
ABORTED measurement aborted
RUNNING measurement not completed

Examples: "CALC:LIM:SPEC:SWIT?"
Result: PASSED

Features: *RST value: --
SCPI: device-specific

Modes: BTS, MS

This command is a query and therefore not assigned a *RST value. The numeric suffixes <1|2> or <1 to 8> are not significant for this command.

CALCulate<1|2>:LIMit<1 to 8>:SPECtrum:SWITching:FAILs?

This command queries the number of limit violations of the spectrum due to switching transient measurement.

Examples: "CALC:LIM:SPEC:SWIT:FAIL?"

Features: *RST value: --
SCPI: device-specific

Modes: BTS, MS

This command is a query and therefore not assigned a *RST value. The numeric suffixes <1|2> or <1 to 8> are not significant for this command.

CALCulate<1|2>:LIMit<1 to 8>:SPURious? TXBand | OTXBand | RXBand | IDLeband

This command queries the total result of the spurious emissions measurement.

Parameter: The result is displayed in character data form. Possible values are:
 PASSED limit not exceeded
 FAILED limit exceeded
 ABORTED measurement aborted
 RUNNING measurement not completed

Examples: "CALC:LIM:SPUR? OTXB"
 Result: PASSED

Features: *RST value: --
 SCPI: device-specific

Modes: BTS, MS
 TXBand TX-band
 OTXBand Not TX-band
 RXBand RX-band (option FSE-K11 only)
 IDLeband IDLeband (option FSE-K10 only)

This command is a query and therefore not assigned a *RST value. The numeric suffixes <1|2> or <1 to 8> are not significant for this command.

CALCulate<1|2>:LIMit<1 to 8>:SPURious:FAILs? TXBand | OTXBand | RXBand | IDLeband

This command queries the number of limit violations of the spurious emissions measurement.

Examples: "CALC:LIM:SPUR:FAIL? OTXB"

Features: *RST value: --
 SCPI: device-specific

Modes: BTS, MS
 TXBand TX-band
 OTXBand Not TX-band
 RXBand RX-band (option FSE-K11 only)
 IDLeband IDLeband (option FSE-K10 only)

This command is a query and therefore not assigned a *RST value. The numeric suffixes <1|2> or <1 to 8> are not significant for this command.

CALCulate<1|2>:LIMit<1 to 8>:MARGin 0 to 100DB

This command sets/changes the value of the margin (safe difference to the actual limit) for the limit check.

Examples: "CALC:LIM:MARG 6DB"

Features: *RST value: 3DB
 SCPI: device-specific

Modes: BTS, MS

The numeric suffixes <1|2> or <1 to 8> are not significant for this command.

4.1.2 CONFigure Subsystem

The CONFigure subsystem contains commands for configuring complex measurement tasks, like those provided by the option GSM BTS Analyzer (FSE-K11) and GSM MS Analyzer (FSE-K10). The CONFigure subsystem is closely linked to the functions of the FETCH and READ subsystems, where the measurement cycles are started and/or the results of the measurements are queried.

4.1.2.1 CONFigure:BTS Subsystem

This subsystem provides the commands for configuring the GSM BTS Analyzer mode (Option FSE-K11) for analyzing the behavior of base stations corresponding to the standards P-GSM, E-GSM, R-GSM, DCS1800 or PCS1900.

COMMAND	PARAMETERS	UNIT	COMMENT
CONFigure			
[:BTS]			Option FSE-K11
:ARFCn	<numeric_value>	--	
:AUTO	ONCE		no query
:LIMit			
:PPEak	<numeric_value>	DEG	
:PRMS	<numeric_value>	DEG	
:FREQuency	<numeric_value>	PPM	
:STANdard	<Boolean>		
:POWer			
:CLASs	<numeric_value> M1 M2 M3	--	
:COUPlEd	<Boolean>		
:STATic	<numeric_value>	--	
:DYNamic	<numeric_value>	--	
:EXPEctEd	<numeric_value>	DBM	
:LIMit	<numeric_value>	DBM	
:SINGle			
[:STATe]	<Boolean>		
:CLEar	--		no query
:CHANnel			
:SLOT	<numeric_value>	--	
:AUTO	ONCE		no query
:TSC	<numeric_value>	--	
:AUTO	<Boolean>		
:SFH	<Boolean>		
:NETWork			
[:TYPE]	PGSM PGSM900 EGSM EGSM900 DCS GSM1800 PCS GSM1900 RGSM RGSM900		
:PHASe	1 2[,PLUS]		
:COSiting	<Boolean>		
:TXSupp	<Boolean>		
:PRESet	--		
:SWEeptime	STANdard AUTO		

CONFigure[:BTS]:ARFCn <numeric_value>

This command selects the number of the transmission channel of the base station.

Parameter: <numeric_value>::= 1 to 124 (P-GSM phase I/II)
 0 to 124, 975 to 1023 (E-GSM)
 0 to 124, 955 to 1023 (R-GSM)
 512 to 885 (DCS1800 phase I/II/II+)
 512 to 810 (PCS1900)

Example: "CONF:ARFC 67"

Features: *RST value: 1 (P-GSM phase I/II)
 0 (E-GSM, R-GSM)
 512 (DCS1800 phase I/II/II+)
 512 (PCS1900)

SCPI: device-specific

Mode: BTS

CONFigure[:BTS]:ARFCn:AUTO ONCE

This command is used to search for the channel number of the transmission channel of the base station automatically. This requires only one channel to be active.

Example: "CONF:ARFC:AUTO ONCE"

Features: *RST value: --
 SCPI: device-specific

Mode: BTS

This command is an event and thus has no query and no *RST value assigned.

CONFigure[:BTS]:LIMit:PPEak <numeric_value>

This command determines the phase error limits in degrees for the phase/frequency measurement (peak value).

Example: "CONF:LIM:PPE 66"

Feature: *RST value: depending on standard
 SCPI: device-specific

Mode: BTS

CONFigure[:BTS]:LIMit:PRMS <numeric_value>

This command determines the phase error limits in degrees for the phase/frequency measurement (mean value).

Example: "CONF:LIM:PRMS 22"

Feature: *RST value: depending on standard
 SCPI: device-specific

Mode: BTS

CONFigure[:BTS]:LIMit:FREQuency <numeric_value>

This command determines the frequency error limits in ppm for the phase/frequency measurement.

Example: "CONF:LIM:FREQ 36"
Feature: *RST value: depending on standard
 SCPI: device-specific
Mode: BTS

CONFigure[:BTS]:LIMit:STANdard ON | OFF

This command switches between user-defined (OFF) and standard-defined (ON) limit values.

Example: "CONF:LIM:STAN ON"
Feature: *RST value: ON
 SCPI: device-specific
Mode: BTS

CONFigure[:BTS]:POWer:CLASs <numeric_value> | M1 | M2 | M3

This command defines the power class of the base station.

Parameter: <numeric_value> ::= 1 to 8 (P-GSM phase I/II, E-GSM, R-GSM)
 ::= 1 to 4 (PCS1900, DCS1800 phase I/II/II+)
 M1, M2, M3 ::= Power Classes for Micro BTS
Example: "CONF:POW:CLAS 4"
Features: *RST value: 4 (P-GSM phase I/II, E-GSM, R-GSM)
 1 (DCS1800, PCS1900)
 SCPI: device-specific
Mode: BTS

CONFigure[:BTS]:POWer:COUPlEd ON | OFF

This command switches between user-defined (OFF) and standard-defined (ON) level values.

Example: "CONF:POW:COUP ON"
Feature: *RST value: ON
 ON standard
 OFF user-defined
 SCPI: device-specific
Mode: BTS

CONFigure[:BTS]:POWer:STATic 0 to 6

This command defines the static power control level of the base station.

Example: "CONF:POW:STAT 3"
Features: *RST value: 0
 SCPI: device-specific
Mode: BTS

CONFigure[:BTS]:POWer:DYNamic 0 to 15

This command defines the dynamic power control level of the base station.

Example: "CONF:POW:DYN 5"
Features: *RST value: 0
 SCPI: device-specific
Mode: BTS

CONFigure[:BTS]:POWer:EXPeCted <numeric_value>

This command enters directly the rated output level of the base station specified by the manufacturer.

Example: "CONF:POW:EXP 43DBM"
Features: *RST value: 46 dBm (P-GSM phase I/II, E-GSM, R-GSM)
 43 dBm (DCS1800, PCS1900)
 SCPI: device-specific
Mode: BTS

CONFigure[:BTS]:POWer:LIMit <numeric_value>

This command defines the level for the selection of level-dependent limit lines.

Example: "CONF:POW:LIM 65DBM"
Feature: *RST value: depending on standard
 SCPI: device-specific
Mode: BTS

This command is only available for the setting CONFigure[:BTS]:POWer:COUPLed OFF.

CONFigure[:BTS]:POWer:SINGle[:STATe] ON | OFF

This command switches single measurement of carrier power on and off.

Example: "CONF:POW:SING ON"
Feature: *RST value: OFF
 SCPI: device-specific
Mode: BTS

CONFigure[:BTS]:POWer:SINGle:CLEar

This command clears the table containing the single-step carrier power measurements.

Example: "CONF:POW:SING:CLE"
Feature: *RST value: --
 SCPI: device-specific
Mode: BTS

This command is an event and has therefore neither *RST value nor query.

CONFigure[:BTS]:CHANnel:SLOT 0 to 7

This command selects the slot number within a transmission frame of the base station.

Example: "CONF:CHAN:SLOT 3"
Features: *RST value: 0
 SCPI: device-specific
Mode: BTS

On changing the slot number, the number of the midamble (TSC) is automatically adapted to the slot.

CONFigure[:BTS]:CHANnel:SLOT:AUTO ONCE

This command automatically searches for the slot number within a transmission frame of the base station. This requires only one slot to be active.

Example: "CONF:CHAN:SLOT:AUTO ONCE"
Features: *RST value: --
 SCPI: device-specific
Mode: BTS

This command is an event and thus has no query and no *RST value assigned.

CONFigure[:BTS]:CHANnel:SFH ON | OFF

This command defines whether the base station uses slow frequency hopping or not.

Example: "CONF:CHAN:SFH ON"
Features: *RST value: OFF
 SCPI: device-specific
Mode: BTS

This command is available only when spurious or transient spectrum measurement is selected. The settings for spurious measurement are independent from those selected for transient spectrum.

CONFigure[:BTS]:CHANnel:TSC:AUTO ON | OFF

This command couples the midamble (training sequence TSC_0 to 7) to the slot, i.e. if the slot number is changed the training sequence in the ON state is automatically adapted. In the OFF state, the training sequence set is conserved even if the slot number is changed.

Example: "CONF:CHAN:TSC:AUTO ON"
Features: *RST value: ON
 SCPI: device-specific
Mode: BTS

CONFigure[:BTS]:CHANnel:TSC 0 to 7

This command selects the midamble (training sequence TSC_0 to 7) of the active slot.

Example: "CONF:CHAN:TSC 3"
Features: *RST value: 0
 SCPI: device-specific
Mode: BTS

CONFigure[:BTS]:NETWork[:TYPE] PGSM | PGSM900 | EGSM |EGSM900 | DCS |GSM1800 | PCS|GSM1900 | RGSM | RGSM900

This command selects the standard type according to which the base station will work.

Example: "CONF:NETW DCS"
Features: *RST value: GSM
 SCPI: device-specific
Mode: BTS

CONFigure[:BTS]:NETWork:PHASe 1|2 [,PLUS]

This command selects the phase of the standard according to which the base station will work.

Example: "CONF:NETW:PHAS 2"
Features: *RST value: 1
 SCPI: device-specific
Mode: BTS

CONFigure[:BTS]:COSiting ON | OFF

This command selects whether the base station has the "cositing" feature.

Example: "CONF: COS ON"
Features: *RST value: OFF
 SCPI: device-specific
Mode: BTS

This command is available only if spurious emission measurement is selected.

CONFigure[:BTS]:TXSupp ON | OFF

This command defines that an additional carrier suppression of min. 20dB is taken into account for the measurement. If there is already suppression, a more sensitive setting of the instrument is selected.

Example: "CONF:TXS ON"
Features: *RST value: OFF
 SCPI: device-specific
Mode: BTS

For measurements in the RX-band the value is automatically set to ON.

CONFigure[:BTS]:PRESet

This command resets the parameters for the standard selected to their default values (DEFAULT SETTINGS).

Example: "CONF: PRES"
Features: *RST value: --
 SCPI: device-specific
Mode: BTS

This command is an event and has thus no query and no *RST value assigned.

CONFigure[:BTS]:SWEeptime STANdard | AUTO

This command selects the sweep-time computing mode for the spurious measurement:

Example: "CONF:SWE AUTO"

Feature: *RST value: STANdard
SCPI: device-specific

Mode: BTS

STANdard The computation of the sweep time is based on a worst-case estimation

AUTO The sweep time is reduced by a factor of 8 (assuming all slots are on).

4.1.2.2 CONFigure:BURSt Subsystem

This subsystem provides the commands for configuring the measurements in the GSM BTS Analyzer mode (option FSE-K11) or GSM MS Analyzer mode (option FSE-K10) which are performed on individual bursts. (carrier power, phase/frequency error, power vs. time).

COMMAND	PARAMETERS	UNIT	COMMENT
CONFigure			
:BURSt			
:PFERror			Option FSE-K11&FSE-B7 or FSE-K10&FSE-B7
[:IMMediate]	--	--	no query
:COUNt	<numeric_value>	--	
:POWer			Option FSE-K11 or FSE-K10
[:IMMediate]	--	--	no query
:COUNt	<numeric_value>	--	
:CONDition	NORMal EXTReme		
:PTEmplate			Option FSE-K11 or FSE-K10
[:IMMediate]	--	--	no query
:COUNt	<numeric_value>	--	
:SELEct	FULL TOP RISing FALLing		
:REFerence			Option FSE-K11 or FSE-K10
:AUTO	<Boolean>		

CONFigure:BURSt:PFERror[:IMMediate]

This command selects measurement of the phase and frequency error of the base station or mobile.

Example: "CONF: BURS: PFER "

Features: *RST value: --
SCPI: device-specific

Modes: BTS, MS

This command is an event and thus has no query and no *RST value assigned. It is available only in conjunction with option GSM BTS Analyzer FSE-K11 and Vector Signal Analysis FSE-B7 or in conjunction with option GSM MS Analyzer, FSE-K10, and Vector Signal Analysis, FSE-B7.

CONFigure:BURSt:PFERror:COUNt 1 to 1000

This command sets the number of bursts used for the determination of average and maximum value.

Example: "CONF: BURS: PFER: COUN 100 "

Features: *RST value: 500 (GSM/DCS1800 Phase I)
200 otherwise
SCPI: device-specific

Modes: BTS, MS

CONFigure:BURSt:POWER[:IMMediate]

This command selects measurement of the average carrier power of the base station or mobile.

Example: "CONF: BURS: POW"
Features: *RST value: --
 SCPI: device-specific
Modes: BTS, MS

This command is an event and thus has no query and no *RST value assigned.

CONFigure:BURSt:POWER:COUNT 1 to 1000

This command sets the number of bursts used for the determination of measured values.

Example: "CONF: BURS: POW: COUN 100 "
Features: *RST value: 500 (GSM/DCS1800 phase I)
 200 otherwise
 SCPI: device-specific
Modes: BTS, MS

CONFigure:BURSt:POWER:CONDition NORMal | EXTReMe

This command defines the conditions for power measurement.

Example: "CONF: BURS: POW: COND EXTR "
Features: *RST value: NORMal
 SCPI: device-specific
Modes: BTS, MS

CONFigure:BURSt:PTEMplate[:IMMediate]

This command selects measurement of power of the base station or mobile vs. time.

Example: "CONF: BURS: PTEM"
Features: *RST value: --
 SCPI: device-specific
Modes: BTS, MS

This command is an event and thus has no query and no *RST value assigned.

CONFigure:BURSt:PTEMplate:COUNT 1 to 1000

This command defines the number of bursts used for determining the measured value.

Example: "CONF: BURS: PTEM: COUN 100 "
Features: *RST value: 500 (GSM/DCS1800 phase I)
 200 otherwise
 SCPI: device-specific
Modes: BTS, MS

CONFigure:BURSt:PTEMplate:SElect FULL | TOP | RISing | FALLing

This command defined the burst section to be measured.

Example: "CONF: BURS: PTEM: SEL TOP"

Features: *RST value: FULL
SCPI: device-specific

Modes: BTS, MS

CONFigure:BURSt:REFerence:AUTO ON | OFF

This command switches between automatic and user-activated preview of power versus time. When switched to AUTO, the preview is always performed, when switched to OFF it is omitted. Note: see
READ: BURSt: REF: IMM

Example: "CONF: BURS: REF: AUTO ON"

Feature: *RST value: AUTO
SCPI: device-specific

Mode: BTS, MS

4.1.2.3 CONFigure:MS Subsystem

This subsystem provides the commands for configuring the GSM MS Analyzer mode (Option FSE-K10) for analyzing the behavior of mobiles corresponding to the standards P-GSM, E-GSM, R-GSM, DCS1800 or PCS1900.

COMMAND	PARAMETERS	UNIT	COMMENT
CONFigure			
[:MS]			Option FSE-K10
:ARFCn	<numeric_value>	--	
:AUTO	ONCE		no query
:LIMit			
:PPEak	<numeric_value>	DEG	
:PRMS	<numeric_value>	DEG	
:FREQuency	<numeric_value>	PPM	
:STANdard	<Boolean>		
:POWer	<Boolean>		
:CLASs			
:COUPled	<numeric_value>	--	
:LEVel	<numeric_value>	--	
:LIMit	<numeric_value>	DBM	
:EXPEcted	<numeric_value>	DBM	
:SINGle			
[:STATe]	<Boolean>	--	
:CLEar	--		no query
:SMALI	<Boolean>		
:CHANnel			
:SFH	<Boolean>		
:TSC	<numeric_value>		
:NETWork		--	
[:TYPE]	PGSM PGSM900 EGSM EGSM900 DCS GSM1800 PCS GSM1900 RGSM RGSM900		
:PHASe	1 2[, PLUS]		
:TXSupp	<Boolean>		
:PRESet	--		
:SWEeptime	STANdard AUTO		

CONFigure[:MS]:ARFCn <numeric_value>

This command selects the number of the transmission channel of the mobile.

Parameter: <numeric_value>::= 1 to 124 (P-GSM phase I/II)
 0 to 124, 975 to 1023 (E-GSM)
 0 to 124, 955 to 1023 (R-GSM)
 512 to 885 (DCS1800 phase I/II/II+)
 512 to 810 (PCS1900)

Example: "CONF:ARFC 67"

Features: *RST value: 1 (P-GSM phase I/II)
 0 (E-GSM, R-GSM)
 512 (DCS1800 phase I/II/II+)
 512 (PCS1900)

SCPI: device-specific

Mode: MS

CONFigure[:MS]:ARFCn:AUTO ONCE

This command selects automatically the transmission channel of the mobile.

Example: "CONF:ARFC:AUTO ONCE"
Features: *RST value: -
SCPI: device-specific
Mode: MS

CONFigure[:MS]:LIMit:PPEak <numeric_value>

This command determines the phase error limits in degrees for the phase/frequency measurement (peak value).

Example: "CONF:LIM:PPE 66"
Feature: *RST value: depending on standard
SCPI: device-specific
Mode: MS

CONFigure[:MS]:LIMit:PRMS <numeric_value>

This command determines the phase error limits in degrees for the phase/frequency measurement (mean value).

Example: "CONF:LIM:PRMS 22"
Feature: *RST value: depending on standard
SCPI: device-specific
Mode: MS

CONFigure[:MS]:LIMit:FREQuency <numeric_value>

This command determines the frequency error limits in ppm for the phase/frequency measurement.

Example: "CONF:LIM:FREQ 36"
Feature: *RST value: depending on standard
SCPI: device-specific
Mode: MS

CONFigure[:MS]:LIMit:STANdard ON | OFF

This command switches between user-defined (OFF) and standard-defined (ON) limit values.

Example: "CONF:LIM:STAN ON"
Feature: *RST value: ON
SCPI: device-specific
Mode: MS

CONFigure[:MS]:POWER:CLASs <numeric_value>

This command defines the power class of the mobile.

Parameter: <numeric_value> ::= 1 to 5 (P-GSM phase I)
 2 to 5 (P-GSM phase II)
 2 to 5 (E-GSM, R-GSM)
 1 to 2 (DCS1800 phase I)
 1 to 3 (DCS1800 phase II/II+)
 1 to 3 (PCS1900)

Example: "CONF:POW:CLAS 4"

Features: *RST value: 2 (P-GSM phase I/II, E-GSM, R-GSM)
 1 (DCS1800, PCS1900)
 SCPI: device-specific

Mode: MS

CONFigure[:MS]:POWER:COUPlEd ON | OFF

This command switches between user-defined (OFF) and standard-defined (ON) level values.

Example: "CONF:POW:COUP ON"

Feature: *RST value: ON
 ON standard
 OFF user-defined
 SCPI: device-specific

Mode: MS

CONFigure[:MS]:POWER:LEVEl 0 to 31

This command defines the power control level of the mobile.

Example: "CONF:POW:LEV 5"

Features: *RST value: 2 (P-GSM Phase I/II, E-GSM, R-GSM)
 0 (DCS1800, PCS1900)
 SCPI: device-specific

Mode: MS

CONFigure[:MS]:POWER:LIMit <numeric_value>

This command defines the level for the selection of level-dependent limit lines.

Example: "CONF:POW:LIM 65DBM"

Feature: *RST value: depending on standard
 SCPI: device-specific

Mode: MS

This command is only available for the setting CONFigure[:MS]:POWER:COUPlEd OFF.

CONFigure[:MS]:POWER:EXPEctEd <numeric_value>

This command enters directly the rated output level of the mobile.

Example: "CONF:POW:EXP 43DBM"

Features: *RST value: 46 dBm (P-GSM phase I/II, E-GSM, R-GSM)
 43 dBm (DCS1800, PCS1900)
 SCPI: device-specific

Mode: MS

CONFigure[:MS]:POWER:SINGLE:STATe ON | OFF

This command switches single measurement of carrier power on and off.

Example: "CONF:POW:SING ON"
Feature: *RST value: OFF
 SCPI: device-specific
Mode: MS

CONFigure[:MS]:POWER:SINGLE:CLEAr

This command clears the table containing the single-step carrier power measurements.

Example: "CONF:POW:SING:CLE"
Feature: *RST value: --
 SCPI: device-specific
Mode: MS

This command is an event and has therefore neither *RST value nor query.

CONFigure[:MS]:POWER:SMALI ON | OFF

This command switches the limits for spurious measurement in the RGSM range. The command is available only for Phase II+.

Example: "CONF:POW:SMAL ON"
Feature: *RST value: OFF
 SCPI: device-specific
Mode: MS

CONFigure[:MS]:CHANnel:SFH ON | OFF

This command switches slow-frequency hopping on or off.

Example: "CONF:CHAN:SFH ON"
Feature: *RST value: OFF
 SCPI: device-specific
Mode: MS

CONFigure[:MS]:CHANnel:TSC 0 to 7

This command selects the midamble used by the mobile.

Parameter: 0 to 7 (training sequence for the Normal Burst)
Example: "CONF:CHAN:TSC 3"
Features: *RST value: 0
 SCPI: device-specific
Mode: MS

CONFigure[:MS]:NETWork[:TYPE] PGSM | PGSM900 | EGSM | EGSM900 | DCS | GSM1800 | PCS
| GSM1900 | RGSM | RGSM900

This command selects the standard type according to which the mobile will work.

Example: "CONF:NETW DCS"
Features: *RST value: GSM
 SCPI: device-specific
Mode: MS

CONFigure[:MS]:NETWork:PHASe 1 | 2 [,PLUS]

This command selects the phase of the standard according to which the mobile will work.

Example: "CONF:NETW:PHAS 2"
Features: *RST value: 1
 SCPI: device-specific
Mode: MS

CONFigure[:MS]:TXSupp ON | OFF

This command defines that an additional carrier suppression of min. 20dB is taken into account for the measurement. If there is already suppression, a more sensitive setting of the instrument is selected.

Example: "CONF:TXS ON"
Features: *RST value: OFF
 SCPI: device-specific
Mode: MS

For measurements in the RX-band the value is automatically set to ON.

CONFigure[:MS]:PRESet

This command resets the parameters for the standard selected to their default values (DEFAULT SETTINGS).

Example: "CONF:PRES"
Features: *RST value: --
 SCPI: device-specific
Mode: MS

This command is an event and has thus no query and no *RST value assigned.

CONFigure[:MS]:SWEeptime STANdard | AUTO

This command selects the sweep-time computing mode for the spurious measurement:

Example: "CONF:SWE:STAN AUTO"
Feature: *RST value: STANdard
 SCPI: device-specific
Mode: MS

STANdard The computation of the sweep time is based on a worst-case estimation
 AUTO The sweep time is reduced by a factor of 8 (assuming all slots are on).

4.1.2.4 CONFigure:SPECTrum Subsystem

This subsystem provides the commands for configuring the measurements in the GSM BTS Analyzer mode (FSE-K11) or in the GSM MS Analyzer mode (FSE-K10) used to determine the power of the spectral contributions due to modulation and switching (modulation spectrum, transient spectrum).

COMMAND	PARAMETERS	UNIT	COMMENT
CONFigure			
:SPECTrum			
:MODulation			
[:IMMEDIATE]	--	--	Option FSE-K11 or FSE-K10, no query
:COUNT	<numeric_value>	--	Option FSE-K11 or FSE-K10
:RANGE	ARFCn TXBand RXBand COMBined DCSRx1800		Option FSE-K11 or FSE-K10
:TGATe	<Boolean>		Option FSE-K11
:SWITChing			Option FSE-K11 or FSE-K10, no query
[:IMMEDIATE]	--	--	
:COUNT	<numeric_value>	--	

CONFigure:SPECTrum:MODulation[:IMMEDIATE]

This command selects measurement of the spectrum due to modulation.

Example: "CONF:SPEC:MOD"

Features: *RST value: --
 SCPI: device-specific

Modes: BTS, MS

This command is an event and has thus no query and no *RST value assigned.

CONFigure:SPECTrum:MODulation:COUNT 1 to 1000

This command sets the number of bursts used for determining the average and maximum values.

Example: "CONF:SPEC:MOD:COUN 100"

Features: *RST value: 500 (GSM/DCS1800 phase I)
 200 otherwise
 SCPI: device-specific

Modes: BTS, MS

CONFigure:SPECTrum:MODulation:RANGE ARFCn | TXBand | RXBand | COMBined | DCSRx1800

This command selects the frequency range for the measurement.

Example: "CONF:SPEC:MOD:RANG TXB"

Features: *RST value: ARFCn
 SCPI: device-specific

Modes: BTS, MS

ARFCn	ARFCN ± 1.8 MHz	COMBined	ARFCN ± 1.8 MHz / TX-band
TXBand	TX-band	DCSRx1800	RX-Band DCS 1800 (option FSE-K10 only)
RXBand	RX-band		

CONFigure:SPECTrum:SWITching[:IMMEDIATE]

This command selects measurement of the spectrum due to switching transients.

Example: "CONF:SPEC:SWIT "
Features: *RST value: --
SCPI: device-specific
Modes: BTS, MS

This command is an event and has thus no query and no *RST value assigned.

CONFigure:SPECTrum:MODulation:TGATe ON | OFF

This command switches gating in the TX band on or off.
If gating is switched off, all 8 slots should be active.

Example: "CONF:SPEC:MOD:TGAT ON"
Features: *RST value: OFF
SCPI: device-specific
Mode: BTS

CONFigure:SPECTrum:SWITching:COUNt 1 to 1000

This command defines the number of bursts used for determining the average and maximum values.

Example: "CONF:SPEC:SWIT:COUN 100 "
Features: *RST value: 500 (GSM/DCS1800 phase I)
200 otherwise
SCPI: device-specific
Modes: BTS, MS

4.1.2.5 CONFigure:SPURious Subsystem

This subsystem provides commands for configuring the measurements in the GSM BTS (FSE-K11) or GSM MS (FSE-K10) Analyzer mode used for measuring the power of spurious emissions.

COMMAND	PARAMETERS	UNIT	COMMENT
CONFigure :SPURious [:IMMEDIATE]	--	--	Option FSE-K11, FSE-K10
:COUNT	<numeric_value>	--	Option FSE-K11, FSE-K10
:RXBand	<numeric_value>	--	Option FSE-K11
:RANGe	TXBand OTXBand RXBand IDLeband COMBined	--	Option FSE-K11, FSE-K10
:STEP<1..26>	<Boolean>	--	Option FSE-K11, FSE-K10
:COUNT?			query only
:ANTenna	CONDUCTed RADiated		Option FSE-K10

CONFigure:SPURious[:IMMEDIATE]

This command selects measurement of spurious emissions.

Example: "CONF:SPUR"

Features: *RST value: --
SCPI: device-specific

Modes: BTS, MS

This command is an event and has thus no query and no *RST value assigned.

CONFigure:SPURious:COUNT 1 to 1000

This command sets the number of bursts used for determining the average and maximum values.

Example: "CONF:SPUR:COUN 100"

Features: *RST value: 500 (GSM/DCS1800 phase I)
200 otherwise
SCPI: device-specific

Modes: BTS, MS

The number of bursts in measurements of the RX band is set by command CONFigure:SPURious:RANGe:RXBand (FSE K11 only).

CONFigure:SPURious:COUNT:RXBand 1 to 1000

This command sets the number of bursts used for determining the average and maximum values in measurements of the RX band.

Example: "CONF:SPUR:COUN:RXB 100"

Features: *RST value: 1
SCPI: device-specific

Modes: BTS

CONFigure:SPURious:RANGe TXBand | OTXBand | RXBand | IDLeband | COMBined

This command selects the frequency range used for the measurement.

Example: "CONF:SPUR:RANG OTX"

Features: *RST value: TXB
SCPI: device-specific

Modes: BTS, MS

TXBand TX-Band
OTXBand Not TX-Band
RXBand RX-Band (option FSE-K11 only)
IDLeband Idle band (option FSE-K10 only)
COMBined TX-Band \pm 2 MHz (option FSE-K11 only)

CONFigure:SPURious:STEP<1...26> ON | OFF

This command selects a subband of the selected band for a spurious measurement.

Each band is divided up into 1 to max. 26 subbands, which are selected by the numerical suffix following STEP. A subband is selected for measurement by setting ON.

Example: "CONF:SPUR:STEP24 ON"

Feature: *RST value: ON
SCPI: device-specific

Mode: BTS, MS

CONFigure:SPURious:ANTenna CONDUCTed | RADiated

This command selects the features of the measurement of spurious emissions.

Example: "CONF:SPUR:ANT RAD"

Feature: *RST value: COND
SCPI: device-specific

Mode: MS

4.1.3 FETCh Subsystem

The FETCh subsystem contains commands for reading out results of complex measurement tasks like those provided by options GSM BTS Analyzer, FSE-K11, or GSM MS Analyzer, FSE-K10. The FETCh-subsystem is closely linked to the functions of the CONFigure and READ-subsystems, where the measurement sequences are configured, the measurements are started and their results are queried.

4.1.3.1 FETCh:BURSt Subsystem

This subsystem provides the commands for reading out results of measurements in the GSM BTS (option FSE-K11) or GSM MS (option FSE-K10) Analyzer mode, which are performed on individual bursts (Carrier Power, Phase/Frequency Error) without starting the measurement by themselves.

COMMAND	PARAMETERS	UNIT	COMMENT
FETCh			Option FSE-K11 or FSE-K10
:BURSt			
:PERRor			
:RMS			
:STATus?			query only
:AVERAge?	--		query only
:MAXimum?	--		query only
:PEAK			
:STATus?			query only
:AVERAge?	--		query only
:MAXimum?	--		query only
:FERRor			
:STATus?			query only
:AVERAge?	--		query only
:MAXimum?	--		query only
:POWer			
[:IMMEdiate]?	--		query only
:ALL?	--		query only

FETCh:BURSt:PERRor:RMS:STATus?

This command reads out the status of the RMS-measurement of the phase error taken over the selected number of bursts.

0: failed, 1: passed

Example: "FETC: BURS: PERR: RMS: STAT?"

Features: *RST value: --
 SCPI: device-specific

Modes: BTS, MS

If no measurement has been performed yet, a query error results. This command is a query and has therefore no *RST value assigned.

It is available only when measurement of the phase/frequency error is selected (see CONFigure: BURSt: PFERRor).

FETCh:BURSt:PERRor:RMS:AVERage?

This command reads out the average of the RMS-measurement of the phase error taken over the selected number of bursts.

Example: "FETC: BURS: PERR: RMS: AVER? "

Features: *RST value: --
SCPI: device-specific

Modes: BTS, MS

If no measurement has been performed yet, a query error results. This command is a query and has therefore no *RST value assigned.

It is available only when measurement of the phase/frequency error is selected (see `CONFigure: BURSt: PFERror`).

FETCh:BURSt:PERRor:RMS:MAXimum?

This command reads out the maximum of the RMS-measurement of the phase error for the selected number of bursts.

Example: "FETC: BURS: PERR: RMS: MAX? "

Features: *RST value: --
SCPI: device-specific

Modes: BTS, MS

If no measurement has been performed yet, a query error results.

This command is a query only and therefore has no *RST value assigned. It is available only when measurement of the phase/frequency error is selected (see `CONFigure: BURSt: PFERror`).

FETCh:BURSt:PERRor:PEAK:STATus?

This command reads out the status of the peak measurement of the phase error taken over the selected number of bursts.

0: failed, 1: passed

Example: "FETC: BURS: PERR: PEAK: STAT? "

Features: *RST value --
SCPI: device-specific

Modes: BTS, MS

If no measurement has been performed yet, a query error results.

This command is a query only and therefore has no *RST value assigned. It is available only if measurement of the phase/frequency error is selected (see `CONFigure: BURSt: PFERror`).

FETCh:BURSt:PERRor:PEAK:AVERage?

This command reads out the average of the peak measurement of the phase error taken over the selected number of bursts.

Example: "FETC: BURS: PERR: PEAK: AVER? "

Features: *RST value: --
SCPI: device-specific

Modes: BTS, MS

If no measurement has been performed yet, a query error results.

This command is a query only and therefore has no *RST value assigned. It is available only if measurement of the phase/frequency error is selected (see `CONFigure: BURSt: PFERror`).

FETCh:BURSt:PERRor:PEAK:MAXimum?

This command reads out the maximum of the peak measurement of the phase error for the selected number of bursts.

Example: "FETC: BURS: PERR: PEAK: MAX? "

Features: *RST value: --
SCPI: device-specific

Modes: BTS, MS

If no measurement has been performed yet, a query error results.

This command is a query only and therefore has no *RST value assigned. It is available only when measurement of the phase/frequency error is selected (see `CONFigure: BURSt: PFERror`).

FETCh:BURSt:FERRor:STATus?

This command reads out the status of the measurement of the frequency error taken over the selected number of bursts.

0: failed, 1: passed

Example: "FETC: BURS: FERR: STAT? "

Features: *RST value: --
SCPI: device specific

Modes: BTS, MS

If no measurement has been performed yet, a query error results.

This command is a query only and therefore has no *RST value assigned. It is available only if measurement of the phase/frequency error is selected (see `CONFigure: BURSt: PFERror`).

FETCh:BURSt:FERRor:AVERage?

This command reads out the average of the measurement of the frequency error taken over the selected number of bursts.

Example: "FETC: BURS: FERR: AVER? "

Features: *RST value: --
SCPI: device-specific

Modes: BTS, MS

If no measurement has been performed yet, a query error results.

This command is a query only and therefore has no *RST value assigned. It is available only if measurement of the phase/frequency error is selected (see `CONFigure: BURSt: PFERror`).

FETCh:BURSt:FERRor:MAXimum?

This command reads out the maximum frequency error measured over the selected number of bursts.

Example: "FETC: BURS: FERR: MAX? "

Features: *RST value: --
SCPI: device-specific

Modes: BTS, MS

If no measurement has been performed yet, a query error results.

This command is a query only and therefore has no *RST value assigned. It is available only if measurement of the phase/frequency error is selected (see `CONFigure: BURSt: PFERror`).

FETCh:BURSt:POWer[:IMMediate]?

This command reads out the result of the last step performed during the measurement of the output power of the base station or mobile.

Parameter: The result is output as an ASCII string in the following format:
 <Static Power Ctrl>,<Dyn Power Ctrl>,<Rat-Level>,<Act-Level>, <Delta>,<Status>
 with

<Static Power Ctrl>: current static power control level
 <Dyn Power Ctrl>: current dynamic power control level
 <Rat-Level>: Rated value for the current power control level acc. to standard dBm
 <Act-Level>: measured power in dBm
 <Delta>: Difference between the measured power and the power at the previous static/dynamic power control level.
 <Status>: Result of limit check in character data form:
 PASSED no limits exceeded
 FAILED limit exceeded

Example: "FETC: BURS: POW? "
 Result: 0,0,43,44.1,0,PASSED

Features: *RST value: --
 SCPI: device-specific

Modes: BTS, MS

If no measurement has been performed yet, a query error results.

This command is a query only and therefore has no *RST value assigned. It is available only if measurement of the phase/frequency error is selected (see `CONFigure: BURSt: PFERror`).

FETCh:BURSt:POWer:ALL?

This command reads out the results of all individual steps during the measurement of the output power of the base station or mobile.

Parameter: The result is output as an ASCII string in the following format:
 <Static Power Ctrl>,<Dyn Power Ctrl>,<Rat-Level>,<Act-Level>, <Delta>,<Status>
 with

<Static Power Ctrl>: current static power control level
 <Dyn Power Ctrl>: current dynamic power control level
 <Rat-Level>: Rated value for the current power control level acc. to standard dBm
 <Act-Level>: measured power in dBm
 <Delta>: Difference between the measured power and the power at the previous static/dynamic power control level.
 <Status>: Result of limit check in character data form:
 PASSED no limits exceeded
 FAILED limit exceeded

Example: "FETC: BURS: POW: ALL? "
 Result:
 0,0,43,44.1,0,PASSED,1,0,41,42.5,1.6,PASSED,1,1,35,32.5,5.6,FAILED

Features: *RST value: --
 SCPI: device-specific

Modes: BTS, MS

If no measurement has been performed yet, a query error results.

This command is a query only and therefore has no *RST value assigned. It is available only if measurement of the phase/frequency error is selected (see `CONFigure: BURSt: PFERror`).

4.1.3.2 FETCh:SPECTrum Subsystem

This subsystem provides the commands for reading out results of measurements in the GSM BTS (FSE-K11) or GSM MS (FSE-K10) Analyzer mode, used to measure the power of the spectral contributions due to modulation and switching (modulation spectrum, transient spectrum) without first restarting a new measurement.

COMMAND	PARAMETERS	UNIT	COMMENT
FETCh :SPECTrum :MODulation [:ALL]? :REFerence? :SWITching [:ALL]? :REFerence?	ARFCn TXBand RXBand COMBined DCSRx1800 --		Option FSE-K11 or FSE-K10 query only query only query only

FETCh:SPECTrum:MODulation[:ALL]? ARFCn | TXBand | RXBand | COMBined | DCSRx1800

This command reads out the result of the measurement of the modulation spectrum of the base station or mobile.

Parameter: The result is output as a list of partial result strings separated by ',' in the following (ASCII) format:

<Index>,<Freq1>,<Freq2>,<Level>,<Limit>, <Abs/Rel>,<Status> [, <Index>,<Freq1>,<Freq2>,<Level>,<Limit>, <Abs/Rel>,<Status>]...

where the parts between '['...']' denote a partial result string that can be repeated n times.

<Index>: 0, if the partial result string characterizes a measurement range
current number <>0,
if the partial result string characterizes a single
limit excess.

<Freq1>: Start frequency of the measurement range or
frequency where the limit line is exceeded

<Freq2>: Start frequency of the measurement range or
frequency exceeding the measurement range. The value of
<Freq2> is equal to the value of <Freq1>, if either the
measurement is performed in the time domain or if the
partial result string contains a limit excess.

<Level>: Measured maximum level of the partial range or
measured level at the test point.

<Limit>: Limit in the partial range or at the test point

<Abs/Rel>: ABS <Level> and <Limit> are in absolute units (dBm)

REL <Level> and <Limit> are in relative units (dBm)

<Status>: Result of the limit check in character data form:

PASSED no limit exceeded

FAILED limit exceeded

MARGIN margin exceeded

EXC limit excess marked as an exception

The frequencies <Freq1> and <Freq2> are always absolute i. e. not referred to the carrier frequency.

Example: "FETC:SPEC:MOD? TXB"
 Result: 0,890E6,915E6,-87.4,-108.0,ABS,FAILED,
 1,893.2E6,893.2E6,-83.2,-108.0,ABS,FAILED,
 2,895.7E6,895.7E6,-87.4,-108.0,ABS,FAILED

Features: *RST value: --
 SCPI: device-specific

Modes: BTS, MS
 ARFCn ARFCN \pm 1.8 MHz
 TXBand TX-Band
 RXBand RX-Band
 COMBined ARFCN \pm 1.8 MHz / TX-Band (option FSE-K11 only)
 DCSRx1800 RX band DCS 1800 (option FSE-K10 only)

If no measurement has been performed yet, a query error results.

This command is a query only and therefore has no *RST value assigned. It is available only if measurement of the modulation spectrum is selected (see CONFigure:SPECTrum:MODulation).

FETCh:SPECTrum:MODulation:REFerence?

This command reads out the result of the premeasurement.

Parameter: The result is output as a list of partial result strings separated by ',' in the following (ASCII) format:

<Level1>,<Level2>,<RBW>

<Level1>: measured level

<Level2>: level corrected by means of the bandwidth

<RBW>: bandwidth

Example: "FETC:SPEC:MOD:REF?"
 Result: 36.2,43.2,30000

Features: *RST value: --
 SCPI: device-specific

Modes: BTS, MS

If no measurement has been performed yet, a query error results.

This command is a query only and therefore has no *RST value assigned. It is available only if measurement of the modulation spectrum is selected (see CONFigure:SPECTrum:MODulation).

FETCh:SPECTrum:SWITching[:ALL]?

This command reads out the result of the measurement of the transient spectrum of the base station or mobile.

Parameter: The result is output as a list of partial result strings separated by ',' as for the command `FETCh:SPECTrum:MODulation[:ALL]?`.

Example: `"FETC:SPEC:SWIT?"`
 Result: 0,833.4E6,833.4E6,37.4,-36.0,ABS,MARGIN,
 1,834.0E6,834.0E6,-35.2,-36.0,ABS,FAILED,
 2,834.6E6,834.6E6,-74.3,-75.0,REL,FAILED
 0,835.0E6,835.0E6,-65,0,-60.0,REL,PASSED

Features: *RST value: --
 SCPI: device-specific

Modes: BTS, MS

If no measurement has been performed yet, a query error results.

This command is a query only and therefore has no *RST value assigned. It is available only if measurement of the transient spectrum is selected (see `CONFigure:SPECTrum:SWITching`).

FETCh:SPECTrum:SWITching:REFerence?

This command queries the result of the premeasurement

Parameter: The result is output as a list of partial result strings separated by ',' in the following (ASCII) format:

<Level1>,<Level2>,<RBW>
 <Level1>: measured level
 <Level2>: level corrected by means of the bandwidth
 <RBW>: bandwidth

Example: `"FETC:SPEC:SWIT:REF?"`
 Result: 43.2,43.2,300000

Features: *RST value --
 SCPI: device specific

Modes: BTS, MS

If no measurement has been performed yet, a query error results.

This command is a query only and therefore has no *RST value assigned. It is available only if measurement of the transient spectrum is selected (see `CONFigure:SPECTrum:SWITching`).

4.1.3.3 FETCh:SPURious Subsystem

This subsystem provides the commands for reading out results of measurements in the GSM BTS (FSE-K11) or GSM MS (FSE-K10) Analyzer mode which are used to determine spurious emissions, without first restarting a new measurement.

COMMAND	PARAMETERS	UNIT	COMMENT
FETCh :SPURious [:ALL]? :STEP?	TXBand OTXBand RXBand IDLeband --		Option FSE-K11 or FSE-K10 query only query only

FETCh:SPURious[:ALL]? TXBand | OTXBand | RXBand | IDLeband

This command reads out the results of the measurement of spurious emissions of the base station or mobile which is performed in the LIST mode.

Parameter: The result is output as a list of partial result strings separated by ',' in the following (ASCII) format:

<Index>,<Freq1>,<Freq2>,<Level>,<Limit>, <Abs/Rel>,<Status> [, <Index>,<Freq1>,<Freq2>,<Level>,<Limit>, <Abs/Rel>,<Status>]...

where the parts between '['...''] denote a partial result string that can be repeated n times.

<Index>: 0, if the partial result string characterizes a measurement range current number <>0, if the partial result string characterizes a single limit excess.

<Freq1>: Start frequency of the measurement range or frequency where the limit line is exceeded

<Freq2>: Start frequency of the measurement range or frequency exceeding the measurement range. The value of <Freq2> is equal to the value of <Freq1>, if either the measurement is performed in the time domain or if the partial result string contains a limit excess.

<Level>: Measured maximum level of the partial range or measured level at the test point.

<Limit>: Limit in the partial range or at the test point

<Abs/Rel>: ABS <Level> and <Limit> are in absolute units (dBm)
REL <Level> and <Limit> are in relative units (dBm)

<Status>: Result of the limit check in character data form:

PASSED no limit exceeded
FAILED limit exceeded
MARGIN margin exceeded

Example: "FETCh:SPUR? TXB"

Result: 0,890E6,915E6,-87.4,-108.0,ABS,FAILED,
1,893.2E6,893.2E6,-83.2,-108.0,ABS,FAILED,
2,895.7E6,895.7E6,-87.4,-108.0,ABS,FAILED

Features: *RST value: --
SCPI: device-specific

Modes: BTS, MS

TXBand TX-band RXBand RX-band (option FSE-K11 only)
OTXBand Not TX-band IDLeband Idle band (option FSE-K10 only)

If no measurement has been performed yet, a query error results.

This command is a query only and therefore has no *RST value assigned. It is available only if measurement of the spurious emissions is selected (see CONFIGure:SPURious).

FETCh:SPURious:STEP?

This command reads out the result of the last single step of the measurement of spurious emissions performed in the STEP mode.

Parameter: The result is output as a list of partial result strings separated by ',' as for the command `FETCh:SPURious[:ALL]?`.

Example: "FETC:SPUR:STEP?"

```
Result: 0,890E6,915E6,-87.4,-108.0,ABS,FAILED,
        1,893.2E6,893.2E6,-83.2,-108.0,ABS,FAILED,
        2,895.7E6,895.7E6,-87.4,-108.0,ABS,FAILED
```

Features: *RST value: --
SCPI: device-specific

Modes: BTS, MS

If no measurement has been performed yet, a query error results.

This command is a query only and therefore has no *RST value assigned. It is available only if measurement of the spurious emissions is selected (see `CONFigure:SPURious`).

4.1.3.4 FETCh:PTEMplate Subsystem

This subsystem provides the commands for reading out results of measurements in the GSM BTS (FSE-K11) or GSM MS (FSE-K10) Analyzer mode which are used to determine the carrier power of , power versus time measurement without first restarting a new measurement.

COMMAND	PARAMETER	UNIT	COMMENT
FETCh :PTEMplate :REFerence?			Option FSE-K11, FSE-K10 query only

FETCh:PTEMplate:REFerence?

This command reads out the results of the premeasurement

Parameter: The result is output as a list of partial result strings separated by ',' in the following (ASCII) format:

<Level1>,<Level2>,<RBW>

<Level1>: measured level

<Level2>: level corrected by means of the bandwidth

<RBW>: bandwidth

Example: "FETC:PTEM:REF?"
Result: 43.2,43.2,1000000

Features: *RST value: --
SCPI: device-specific

Modes: BTS, MS

If no measurement has been performed yet, a query error results.

This command is a query only and therefore has no *RST value assigned. It is available only if measurement of Power versus Time is selected (see CONFigure:BURSt:PTEMplate).

4.1.4 INSTRument Subsystem

The INSTRument subsystem selects the operating mode of the unit either via text parameters or fixed numbers. In the split-screen representation, a distinction is made between INSTRument1 (screen A) and INSTRument2 (screen B).

COMMAND	PARAMETERS	UNIT	COMMENT
INSTRument<1 2> [:SElect] :NSElect	SANalyzer DDEMod ADEMod BSGM MSGM <numeric_value>		Vector Signal Analysis FSE-K11 or FSE-K10,

INSTRument<1|2>[:SElect] SANalyzer | DDEMod | ADEMod | BSGM | MSGM

This command switches between the operating modes by means of text parameters.

Parameter: SANalyzer: spectrum analysis
DDEMod: vector signal analysis, digital demodulation
ADEMod: vector signal analysis, analog demodulation
BSGM: GSM BTS analysis
MSGM: GSM MS analysis

Example: "INST DDEM"

Features: *RST value: SANalyzer
SCPI: conforming

Modes: A, VA, BTS, MS

Switchover to BSGM is only possible in conjunction with option FSE-K11, GSM BTS Analyzer
Switchover to MSGM is only possible in conjunction with option FSE-K10, GSM MS Analyzer

INSTRument<1|2>:NSElect 1 to 5

This command switches between the two modes by means of numbers.

Parameter: 1: spectrum analysis
2: vector signal analysis, digital demodulation
3: vector signal analysis, analog demodulation
4: GSM BTS analysis
5: GSM MS analysis

Example: "INST:NSEL 2"

Features: *RST value: 1
SCPI: conforming

Modes: A, VA, BTS, MS

Switchover to 4 is only possible in conjunction with option FSE-K11, GSM BTS Analyzer
Switchover to 5 is only possible in conjunction with option FSE-K10, GSM MS Analyzer

4.1.5 READ Subsystem

The READ-subsystem contains commands for starting complex measurement tasks such as those provided by options GSM BTS Analyzer (FSE-K11) or GSM MS Analyzer (FSE-K10), and for querying the results subsequently. The READ-subsystem is closely linked to the functions of the CONFigure- and FETCh-subsystems, where the measurement sequences are configured or the results are queried without restarting a new measurement.

4.1.5.1 READ:BURSt Subsystem

This subsystem provides the commands for starting measurements in the GSM BTS Analyzer mode (option FSE-K11), which are performed on individual bursts (carrier power, phase/frequency error), and for reading out the results subsequently.

COMMAND	PARAMETERS	UNIT	COMMENT
READ			
:BURSt			Option FSE-K11 or FSE-K10
:PERRor			
:RMS			query only
:STATus?			query only
:AVERAge?	--		query only
:MAXimum?	--		
:PEAK			query only
:STATus?			query only
:AVERAge?	--		query only
:MAXimum?	--		
:FERRor			query only
:STATus?			query only
:AVERAge?	--		query only
:MAXimum?	--		
:POWer?	--		query only; FSE-K11 only
:STATic?	--		query only; FSE-K11 only
:DYNamic?	--		query only; FSE-K10 only
:LEVel?	--		query only
:REFerence			
[:IMMediate?]	--		query only

READ:BURSt:PERRor:RMS:STATus?

This command starts the measurement of the phase and frequency error of the base station or mobile and reads out the status of the RMS-measurement of the phase error taken over the selected number of bursts.

0: failed, 1: passed

Example: "READ: BURS: PERR: RMS: STAT? "

Features: *RST value: --
SCPI: device-specific

Modes: BTS, MS

When the measurement is started the instrument automatically assumes the SINGLE mode.

An ongoing measurement can be aborted via the command `ABORT`. Further results of the phase/frequency error measurement can be then queried without restart of the measurement via the `FETCh: BURSt`-subsystem.

This command is a query only and therefore has no *RST value assigned. It is available only if measurement of the phase/frequency error is selected (see `CONFigure: BURSt: PFERRor`).

READ:BURSt:PERRor:RMS:AVERage?

This command starts the measurement of the phase and frequency error of the base station or mobile and reads out the average of the RMS-measurement of the phase error taken over the selected number of bursts.

Example: "READ: BURS: PERR: RMS: AVER? "

Features: *RST value: --
SCPI: device-specific

Modes: BTS, MS

When the measurement is started the instrument automatically assumes the SINGLE mode.

An ongoing measurement can be aborted via the command `ABORT`. Further results of the phase/frequency error measurement can be then queried without restart of the measurement via the `FETCH: BURSt`-subsystem.

This command is a query only and therefore has no *RST value assigned. It is available only if measurement of the phase/frequency error is selected (see `CONFIGure: BURSt: PFERror`).

READ:BURSt:PERRor:RMS:MAXimum?

This command starts the measurement of the phase and frequency error of the base station or mobile and reads out the maximum of the RMS-measurement of the phase error for the selected number of bursts.

Example: "READ: BURS: PERR: RMS: MAX? "

Features: *RST value: --
SCPI: device-specific

Modes: BTS, MS

When the measurement is started the instrument automatically assumes the SINGLE mode.

An ongoing measurement can be aborted via the command `ABORT`. Further results of the phase/frequency error measurement can be then queried without restart of the measurement via the `FETCH: BURSt`-subsystem.

This command is a query only and therefore has no *RST value assigned. It is available only if measurement of the phase/frequency error is selected (see `CONFIGure: BURSt: PFERror`).

READ:BURSt:PERRor:PEAK:STATus?

This command starts the measurement of the phase and frequency error of the base station or mobile and reads out the status of the peak measurement of the phase error taken over the selected number of bursts.

0: failed, 1: passed

Example: "READ: BURS: PERR: PEAK: STAT? "

Features: *RST value: --
SCPI: device-specific

Modes: BTS, MS

When the measurement is started the instrument automatically assumes the SINGLE mode.

An ongoing measurement can be aborted via the command `ABORT`. Further results of the phase/frequency error measurement can be then queried without restart of the measurement via the `FETCH: BURSt`-subsystem.

This command is a query only and therefore has no *RST value assigned. It is available only if measurement of the phase/frequency error is selected (see `CONFIGure: BURSt: PFERror`).

READ:BURSt:PERRor:PEAK:AVERAge?

This command starts the measurement of the phase and frequency error of the base station or mobile and reads out the maximum of the peak measurement of the phase error taken over the selected number of bursts.

Example: "READ: BURS: PERR: PEAK: AVER? "

Features: *RST value: --
SCPI: device-specific

Modes: BTS, MS

When the measurement is started the instrument automatically assumes the SINGLE mode.

An ongoing measurement can be aborted via the command `ABORT`. Further results of the phase/frequency error measurement can be then queried without restart of the measurement via the `FETCh: BURSt`-subsystem.

This command is a query only and therefore has no *RST value assigned. It is available only if measurement of the phase/frequency error is selected (see `CONFIgure: BURSt: PFERror`).

READ:BURSt:PERRor:PEAK:MAXimum?

This command starts the measurement of the phase and frequency error of the base station or mobile and reads out the maximum of the peak measurement of the phase error for the selected number of bursts.

Example: "READ: BURS: PERR: PEAK: MAX? "

Features: *RST value: --
SCPI: device-specific

Modes: BTS, MS

When the measurement is started the instrument automatically assumes the SINGLE mode.

An ongoing measurement can be aborted via the command `ABORT`. Further results of the phase/frequency error measurement can be then queried without restart of the measurement via the `FETCh: BURSt`-subsystem.

This command is a query only and therefore has no *RST value assigned. It is available only if measurement of the phase/frequency error is selected (see `CONFIgure: BURSt: PFERror`).

READ:BURSt:FERRor:STATus?

This command starts the measurement of the phase and frequency error of the base station or mobile and reads out the status of the frequency error taken over the selected number of bursts.

0: failed, 1: passed

Example: "READ: BURS: FERR: STAT? "

Features: *RST value: --
SCPI: device-specific

Modes: BTS, MS

When the measurement is started the instrument automatically assumes the SINGLE mode.

An ongoing measurement can be aborted via the command `ABORT`. Further results of the phase/frequency error measurement can be then queried without restart of the measurement via the `FETCh: BURSt`-subsystem.

This command is a query only and therefore has no *RST value assigned. It is available only if measurement of the phase/frequency error is selected (see `CONFIgure: BURSt: PFERror`).

READ:BURSt:FERRor:AVERage?

This command starts the measurement of the phase and frequency error of the base station or mobile and reads out the average of the frequency error taken over the selected number of bursts.

Example: "READ: BURS: FERR: AVER? "

Features: *RST value: --
SCPI: device-specific

Modes: BTS, MS

When the measurement is started the instrument automatically assumes the SINGLE mode.

An ongoing measurement can be aborted via the command `ABORT`. Further results of the phase/frequency error measurement can be then queried without restart of the measurement via the `FETCH: BURSt`-subsystem.

This command is a query only and therefore has no *RST value assigned. It is available only if measurement of the phase/frequency error is selected (see `CONFIgure: BURSt: PFERRor`).

READ:BURSt:FERRor:MAXimum?

This command starts the measurement of the phase and frequency error of the base station or mobile and reads out the maximum of the frequency error for the selected number of bursts.

Example: "READ: BURS: FERR: MAX? "

Features: *RST value: --
SCPI: device-specific

Modes: BTS, MS

When the measurement is started the instrument automatically assumes the SINGLE mode.

An ongoing measurement can be aborted via the command `ABORT`. Further results of the phase/frequency error measurement can be then queried without restart of the measurement via the `FETCH: BURSt`-subsystem.

This command is a query only and therefore has no *RST value assigned. It is available only if measurement of the phase/frequency error is selected (see `CONFIgure: BURSt: PFERRor`).

READ:BURSt:POWer?

This command starts the measurement of the maximum output power of the base station or mobile and reads out the result.

Measurement of the maximum output power marks the beginning of a measurement cycle where subsequently the limits of the static and dynamic power control levels are checked step by step (READ:BURSt:STATic? or READ:BURSt:DYNamic?).

Parameter: The result is read out as an ASCII string in the following format:

<Static Power Ctrl>,<Dyn Power Ctrl>,<Rat-Level>,<Act-Level>, <Delta>,<Status>

<Static Power Ctrl>: 0

<Dyn Power Ctrl>: 0

<Rat-Level>: rated value for the current power control level acc.
to standard in dBm

<Act-Level>: measured power in dBm

<Delta>: 0

<Status>: result of limit check in character data form:
PASSED no limits exceeded
FAILED limit exceeded

Example: "READ:BURSt:POW?"
Result: 0,0,43,44.1,0,PASSED

Features: *RST value: --
SCPI: device-specific

Modes: BTS, MS

When the measurement is started any ongoing measurement cycle is aborted.

An ongoing measurement can be aborted with the command ABORT. This command is a query only and has therefore no *RST value assigned. It is available only when measurement of the maximum carrier power is selected (see CONFigure:BURSt:POWer).

READ:BURSt:POWer:STATic?

This command increases the static power control level for the measurement by one step, measures the output power of the base station and reads out the result.

If the command `READ:BURSt:POWer:STATic?` is repeated after the maximum static power control level is reached, the measurement sequence is terminated and the result of the maximum static power control level is read out again. In this case the value 'FINISHED' indicating the status is read out. Before the status value 'FINISHED' is read out, the value 'RUNNING' is output if the total result of the limit check is queried via `CALCulate<1|2>:LIMit<1 to 8>:BURSt:POWer?`.

Parameter: The result is read out as an ASCII string in the following format:

`<Static Power Ctrl>,<Dyn Power Ctrl>,<Rat-Level>,<Act-Level>,<Delta>,<Status>`

`<Static Power Ctrl>`: current static power control level

`<Dyn Power Ctrl>`: current dynamic power control level

`<Rat-Level>`: rated value for the current power control level acc. to standard in dBm

`<Act-Level>`: measured power in dBm

`<Delta>`: difference between the measured power and the power at the previous static power control level.

`<Status>`: result of the limit check in character data form:
 PASSED no limit exceeded
 FAILED limit exceeded
 FINISHED measurement sequence terminated

Example: `"READ:BURSt:POW:STAT?"`
 Result: `1,0,41,42.5,1.6,PASSED`

Features: *RST value: --
 SCPI: device-specific

Mode: BTS

The command `ABORt` terminates an ongoing measurement and resets the static and dynamic power control level to 0.

This command is only a query and therefore has no *RST value assigned. It is available only if measurement of the maximum carrier power is selected. (see `CONFIgure:BURSt:POWer`).

READ:BURSt:POWer:DYNamic?

This command increases the dynamic power control level for the measurement by one step, measures the output power of the base station and reads out the result.

Once the maximum dynamic power control level is reached the command is accepted only after the static power control level is increased by one step.

Note that the command is no longer accepted after the measurement sequence is terminated which implies that the static power control level was read out again with `READ:BURSt:POWer:STATic?` after the maximum value was reached and marked with the 'FINISHED' status.

Parameter: The result is read out as an ASCII string in the following format:

<Static Power Ctrl>,<Dyn Power Ctrl>,<Rat-Level>,<Act-Level>, <Delta>,<Status>

<Static Power Ctrl>: current static power control level

<Dyn Power Ctrl>: current dynamic power control level

<Rat-Level>: rated value for the current power control level acc.
to standard in dBm

<Act-Level>: measured power in dBm

<Delta>: difference between the measured power and the power
at the previous dynamic power control level.

<Status>: result of the limit check in character data form:
PASSED no limit exceeded
FAILED limit exceeded

Example: "READ:BURSt:POWer:DYN?"
Result: 1,3,35,32.5,5.6,FAILED

Features: *RST value: --
SCPI: device-specific

Mode: BTS

The command `ABORt` terminates an ongoing measurement and resets the static and dynamic power control level to 0.

This command is only a query and therefore has no *RST value assigned. It is available only if measurement of the maximum carrier power is selected. (see `CONFigure:BURSt:POWer`).

READ:BURSt:POWer:LEVel?

This command increases the power control level for the measurement by one step, measures the output power of the mobile and reads out the result.

Note that the command is no longer accepted after the measurement sequence is terminated which implies that the power control level was read out again with `READ:BURSt:POWer:LEVel?` after the maximum value was reached and marked with the 'FINISHED' status.

Parameter: The result is read out as an ASCII string in the following format:

<0>, <Power Ctrl Level>,<Rat-Level>,<Act-Level>, <Delta>,<Status>

<0>: always 0 (this field is only significant for option FSE-K11)

<Power Ctrl Level>: current power control level

<Rat-Level>: rated value for the current power control level acc.
to standard in dBm

<Act-Level>: measured power in dBm

<Delta>: difference between the measured power and the power
at the previous power control level.

<Status>: result of the limit check in character data form:
PASSED no limit exceeded
FAILED limit exceeded

Example: "READ: BURS: POW: LEV? "
Result: 0,3,35,32.5,5.6,FAILED

Features: *RST value: --
SCPI: device-specific

Mode: MS

The command `ABORT` terminates an ongoing measurement and resets the power control level to 0.

This command is only a query and therefore has no *RST value assigned. It is available only if measurement of the maximum carrier power is selected. (see `CONFigure:BURSt:POWer`).

READ:BURSt:REFerence[:IMMediate?]

This command starts the premeasurement and as a result provides the measured level in dBm.

Example: "READ: BURS: REF?"

Feature: *RST value: --
SCPI: device-specific

Mode: MS, BTS

This is a query command only and therefore has no *RST value.

4.1.5.2 READ:SPECTrum Subsystem

This subsystem provides the commands for starting measurements in the GSM BTS (option FSE-K11) and GSM MS (option FSE-K10) Analyzer mode, which are used to measure the power of the spectral components due to modulation and switching (modulation spectrum, transient spectrum), and for reading out the results subsequently.

COMMAND	PARAMETERS	UNIT	COMMENT
READ			
:SPECTrum			Option FSE-K11 or FSE-K10
:MODulation			
[:ALL]?	--		query only
:SWITching			
[:ALL]?	--		query only

READ:SPECTrum:MODulation[:ALL]?

This command starts the measurement of the modulation spectrum of the base station or mobile and reads out the result. The measurement is performed in the currently set frequency range.

Parameter: The result is read out as a list of partial ASCII result strings separated by ',' in the following format:

```
<Index>,<Freq1>,<Freq2>,<Level>,<Limit>,<Abs/Rel>,<Status> [,
<Index>,<Freq1>,<Freq2>,<Level>,<Limit>,<Abs/Rel>,<Status>]...
```

where the part set in '['...]' characterizes a partial result string which can be repeated n times.

<Index>: 0, if the partial result string characterizes a measurement range.
current number <>0,
if the partial result string characterizes a single limit excess.

<Freq1>: Start frequency of the measurement range or frequency where the limit is exceeded.

<Freq2>: Stop frequency of the measurement range or frequency where the measured range is exceeded. The value of <Freq2> is equal to the value of <Freq1>, if either the measurement is performed in the time domain or the partial result string contains a limit excess.

<Level>: Measured maximum level of the partial range or measured level at the test point.

<Limit>: Limit in the partial range or at the test point.

<Abs/Rel>: ABS <Level> and <Limit> are in absolute units (dBm)

REL <Level> and <Limit> are in relative units (dBm)

<Status>: Result of the limit check in character data form:

PASSED no limit exceeded

FAILED limit exceeded

MARGIN margin exceeded

EXC limited excess characterized as an exception

The frequencies <Freq1> and <Freq2> are always absolute and not referred to the carrier frequency.

Example: "READ:SPEC:MOD?"

```
Result: 0,890E6,915E6,-87.4,-108.0,ABS,FAILED,
1,893.2E6,893.2E6,-83.2,-108.0,ABS,FAILED,
2,895.7E6,895.7E6,-87.4,-108.0,ABS,FAILED
```

Features: *RST value: --
SCPI: device-specific

Modes: BTS, MS

The command `ABORT` aborts an ongoing measurement. This command is only a query and therefore has no *RST value assigned. It is available only if measurement of the modulation spectrum is selected. (see `CONFIGure:SPECTrum:MODulation`).

READ:SPECTrum:SWITching[:ALL]?

This command starts the measurement of the transient spectrum of the base station or mobile and reads out the result.

Parameter: The result is read out as a list of partial ASCII result strings separated by ',' in the format used for `READ:SPECTrum:MODulation[:ALL]?`.

Example: `"READ:SPEC:SWIT?"`
Result: `0,833.4E6,833.4E6,37.4,-36.0,ABS,MARGIN,`
`1,834.0E6,834.0E6,-35.2,-36.0,ABS,FAILED,`
`2,834.6E6,834.6E6,-74.3,-75.0,REL,FAILED`
`0,835.0E6,835.0E6,-65,0,-60.0,REL,PASSED`

Features: *RST value: --
 SCPI: device-specific

Modes: BTS, MS

The command `ABORT` aborts an ongoing measurement.

This command is only a query and therefore has no *RST value assigned. It is available only if measurement of the transient spectrum is selected. (see `CONFIGure:SPECTrum:SWITChing`).

4.1.5.3 READ:SPURious Subsystem

This subsystem provides the commands for starting measurements in the GSM BTS (option FSE-K11) and GSM MS (option FSE-K10) Analyzer mode, which are used to measure the power of spurious emissions, and for reading out the results subsequently.

COMMAND	PARAMETERS	UNIT	COMMENT
READ :SPURious [:ALL]? :STEP?			Option FSE-K11 or FSE-K10 query only query only

READ:SPURious[:ALL]?

This command starts the measurement of the spurious emissions of the base station or mobile and reads out the result. The measurement is performed in the currently set frequency range.

Parameter: The result is read out as a list of partial ASCII result strings separated by ',' in the following format:

<Index>,<Freq1>,<Freq2>,<Level>,<Limit>, <Abs/Rel>,<Status> [,
<Index>,<Freq1>,<Freq2>,<Level>,<Limit>, <Abs/Rel>,<Status>]...

where the part set in '['...]' characterizes a partial result string which can be repeated n times.

<Index>: 0, if the partial result string characterizes a measurement range.
current number <>0,
if the partial result string characterizes a single limit excess.

<Freq1>: Start frequency of the measurement range or frequency where the limit is exceeded.

<Freq2>: Stop frequency of the measurement range or frequency where the measured range is exceeded. The value of <Freq2> is equal to the value of <Freq1>, if either the measurement is performed in the time domain or the partial result string contains a limit excess.

<Level>: Measured maximum level of the partial range or measured level at the test point.

<Limit>: Limit in the partial range or at the test point.

<Abs/Rel>: ABS <Level> and <Limit> are in absolute units (dBm)
REL <Level> and <Limit> are in absolute units (dBm)

<Status>: Result of the limit check in character data form:
PASSED no limit exceeded
FAILED limit exceeded
MARGIN margin exceeded

Example: "READ:SPUR?"
Result: 0,890E6,915E6,-87.4,-108.0,ABS,FAILED,
1,893.2E6,893.2E6,-83.2,-108.0,ABS,FAILED,
2,895.7E6,895.7E6,-87.4,-108.0,ABS,FAILED

Features: *RST value: --
SCPI: device-specific

Modes: BTS, MS

The command `ABORT` aborts an ongoing measurement. This command is only a query and therefore has no *RST value assigned. It is available only if measurement of the spurious emissions is selected. (see `CONFIGure:SPURious`).

4.1.6 SENSe Subsystem

The SENSe subsystem is itself divided up into several subsystems. The commands of these subsystems directly control device-specific settings, they do not refer to the signal characteristics of the measurement signal.

The SENSe subsystem controls the essential parameters of the analyzer and vector analyzer. In accordance with the SCPI standard, it is for this reason optional, which means that it is not necessary to include the SENSe node in command sequences.

In the split-screen representation, a distinction is made between SENSe1 and SENSe2:

SENSe1 $\hat{=}$ screen A;

SENSe2 $\hat{=}$ screen B

4.1.6.1 SENSe:BANDwidth Subsystem

This subsystem controls the setting of the instrument's filter bandwidths. Both groups of commands (BANDwidth and BWIDth) perform the same functions.

COMMAND	PARAMETERS	UNIT	COMMENT
[SENSe<1 2>] :BANDwidth :BWIDth [:RESolution]	<numeric_value>	HZ	

[SENSe<1|2>:]BANDwidth|BWIDth[:RESolution] <numeric_value>

This command defines the analyzer's resolution bandwidth.

Example: "BAND 1MHz "

Features: *RST value: - (AUTO is set to ON)
SCPI: conforming

Modes: A, VA, BTS, MS

The values for the resolution bandwidth are rounded in 1 | 2 | 3 | 5 steps.

In the GSM BTS/MS ANALYZER mode with option FSE-K11/K10, the command is available for POWER vs. TIME measurement. In this case, the parameters DEFault (bandwidth setting according to GSM standard), 300KHZ and 1MHZ are permitted.

4.1.6.2 SENSe:CORRection-Subsystem

The SENSe:CORRection-subsystem informs the instrument about external attenuation and preamplification.

COMMAND	PARAMETERS	UNIT	COMMENT
[SENSe<1 2>] :CORRection :LOSS :INPut [:MAGNitude]	<numeric_value>	DB	option FSE-K11 or FSE-K10
:RXGain :INPut [:MAGNitude]	<numeric_value>	DB	option FSE-K11 or FSE-K10

[SENSe<1|2>:]CORRection:LOSS:INPut[:MAGNitude] <numeric_value>

This command announces to the instrument a possibly needed external attenuation of the input signal, so that it is taken into account later when the level is set.

Parameter: <numeric_value>::= value of external attenuation in dB.

Example: "CORR:LOSS:INP 30DB "

Features: *RST value: 20dB
SCPI: device-specific

Modes: BTS, MS

The external attenuation must be selected such that the input power of the analyzer does not exceed 27 dBm.

[SENSe<1|2>:]CORRection:RXGain:INPut[:MAGNitude] <numeric_value>

This command announces to the instrument a possibly needed preamplification in the RX-band (RX BAND GAIN), so that it is taken into account later when the measured values are read out.

Parameter: <numeric_value>::= value of the amplification in dB.

Example: "CORR:RXG:INP 30DB "

Features: *RST value: 0 dB
SCPI: device-specific

Modes: BTS, MS

4.1.7 TRIGger Subsystem

The TRIGger subsystem is used to synchronize instrument actions with events. This makes it possible to control and synchronize the start of a sweep. An external trigger signal can be fed to the connector at the rear panel of the instrument. In split screen mode, a distinction is made between TRIGger1 (screen A) and TRIGger2 (screen B).

COMMAND	PARAMETERS	UNIT	COMMENT
TRIGger<1 2> [:SEquence] :SYNChronize :ADJust :FRAMe :AUTO :SLOT :AUTO :SOURCe	<numeric_value> ONCE <numeric_value> ONCE FRAMe TSC	s s	Option FSE-K11 Option FSE-K11 & FSE-B7 Option FSE-K11 Option FSE-K11 & FSE-B7 Option FSE-K11 or FSE-K10 & FSE-B7

TRIGger[:SEquence]:SYNChronize:ADJust:FRAMe 0 to 100s

This command defines the correction value for the time offset between the frame trigger and the midamble of the slot selected. The value set is corrected by means of the calculated offsets of the other slots and used as a base value for the correction of all slots.

This correction value is necessary in order to conserve the exact time relation between the trigger event and the midamble of the slot in question in cases where there is no midamble triggering.

- Example:** "TRIG:SYNC:ADJ:FRAM 30us"
- Features:** *RST value: -- (depending on the slot selected)
SCPI: device-specific
- Modes:** BTS

TRIGger[:SEquence]:SYNChronize:ADJust:FRAMe:AUTO ONCE

This command determines once the correction value for the time offset between the frame trigger and the midamble of the slot selected. The value set is corrected by means of the calculated offsets of the other slots and used as a base value for the correction of all slots.

This correction value is necessary in order to conserve the exact time relation between the trigger event and the midamble of the slot in question in cases where there is no midamble triggering.

- Example:** "TRIG:SYNC:ADJ:FRAM:AUTO ONCE"
- Features:** *RST value: --
SCPI: device-specific
- Modes:** BTS

This command is available only in conjunction with option GSM BTS Analyzer, FSE-K11, and with option Vector Signal Analysis, FSE-B7.

TRIGger[:SEquence]:SYNChronize:ADJust:SLOT 0 to 100s

This command defines the correction value for the time offset between the frame trigger and the midamble of the slot selected, without influencing the correction values of the other slots. This correction value is necessary in order to conserve the exact time relation between the trigger event and the midamble of the slot in question in cases where there is no midamble triggering. The value set is corrected by means of the calculated offsets of the other slots and used as a base value for the correction of all slots.

Example: "TRIG:SYNC:ADJ:SLOT 30us"
Features: *RST value: -- (depending on slot selected)
SCPI: device-specific
Modes: BTS

TRIGger[:SEquence]:SYNChronize:ADJust:SLOT:AUTO ONCE

This command defines the correction value for the time offset between the frame trigger and the midamble of the slot selected. The value set is corrected by means of the calculated offsets of the other slots and used as a base value for the correction of all slots.

This correction value is necessary in order to conserve the exact time relation between the trigger event and the midamble of the slot in question in cases where there is no midamble triggering.

Example: "TRIG:SYNC:ADJ:SLOT:AUTO ONCE"
Features: *RST value: --
SCPI: device-specific
Modes: BTS

This command is available only in conjunction with option GSM BTS Analyzer, FSE-K11, and with option Vector Signal Analysis, FSE-B7.

TRIGger[:SEquence]:SYNChronize:SOURce FRAME | TSC

This command defines the trigger reference point for measurements in the time domain (carrier power, power vs. time). The frame trigger of the base station or mobile may be selected as well as the relation to the midamble (TSC) of the slot to be measured.

Example: "TRIG:SYNC:SOUR TSC"
Features: *RST value: FRAME
SCPI: device-specific
Modes: BTS, MS

This command is available only in conjunction with option GSM BTS Analyzer, FSE-K11, or GSM MS Analyzer, FSE-K10. The parameter TSC requires in addition the option Vector Signal Analysis, FSE-B7.

4.2 Table of Softkeys with IEC/IEEE-Bus Command Assignment

4.2.1 GSM BTS Analysis Mode (Option FSE-K11)

4.2.1.1 CONFIGURATION Key Group

MODE	
GSM BTS ANALYZER	INSTRument<1 2>[:SElect] BGSM
SETTINGS	--
EXTERNAL ATTEN	[SENSe<1 2>:]CORRection:LOSS:INPut[:MAGNitude] <numeric_value>
ARFCN / FREQUENCY	--
ARFCN	CONFIgure:BTS:ARFCn <numeric_value>
ARFCN AUTOSELECT	CONFIgure:BTS:ARFCn:AUTO ONCE
FREQUENCY	SENSe<1 2>:FREQUency:CENTer <numeric_value>
POWER SETTINGS	--
EXTERNAL ATTEN	[SENSe<1 2>:]CORRection:LOSS:INPut[:MAGNitude] <numeric_value>
NOMINAL OUTPUTPWR	CONFIgure:BTS:POWer:EXPEcted <numeric_value>
POWER CLASS	CONFIgure:BTS:POWer:CLASs <numeric_value> M1 M2 M3
STATIC PWR CTRL LEVEL	CONFIgure:BTS:POWer:STATic <numeric_value>
DYNAM PWR CTRL LEVEL	CONFIgure:BTS:POWer:DYNamic <numeric_value>
LIMIT/PWR COUPLED	CONFIgure:BTS:POWer:COUPled ON OFF
SIGNAL POWER	CONFIgure:BTS:POWer:EXPEcted <numeric_value>
LIMIT LINE REF POWER	CONFIgure:BTS:POWer:LLINe <numeric_value>
LIMIT MARGIN	CALCulate<1 2>:LIMit<1...8>:MARGIn <numeric_value>
SLOT NO.	--
SLOT NO.	CONFIgure:BTS:CHANnel:SLOT 0...7

SLOT NO. AUTOSELECT	CONFigure:BTS:CHANnel:SLOT:AUTO ONCE
MIDAMBLE	CONFigure:BTS:CHANnel:TSC 0...7 CONFigure:BTS:CHANnel:TSC:AUTO ON OFF
TRIGGER	--
FREE RUN	TRIGger<1 2>[:SEQuence]:SOURce IMMEDIATE
EXTERN	TRIGger<1 2>[:SEQuence]:SOURce EXTERNAL TRIGger<1 2>[:SEQuence]:LEVel[:EXTERNAL] -5.0...+5.0V
SLOPE POS NEG	TRIGger<1 2>[:SEQuence]:SLOPe POSitive NEGative
TRIGGER ADJUST	--
FRAME COARSE	TRIGger<1 2>[:SEQuence]:SYNChronize:ADJust:FRAME <numeric_value>
FRAME FINE	TRIGger<1 2>[:SEQuence]:SYNChronize:ADJust:FRAME <numeric_value>
AUTO FRAME ADJUST	TRIGger<1 2>[:SEQuence]:SYNChronize:ADJust:FRAME:AUTO ONCE
SLOT ADJUST	TRIGger<1 2>[:SEQuence]:SYNChronize:ADJust:SLOT <numeric_value>
AUTO SLOT ADJUST	TRIGger<1 2>[:SEQuence]:SYNChronize:ADJust:SLOT:AUTO ONCE
TRIGGER LEVEL	TRIGger<1 2>[:SEQuence]:LEVel[:EXTERNAL] <numeric_value>
SLOPE POS NEG	TRIGger<1 2>[:SEQuence]:SLOPe POSitive NEGative
DEFAULT SETTINGS	CONFigure:BTS:PRESet
P-GSM 900	CONFigure:BTS:NETWork[:TYPE] PGSM PGSM900
E-GSM 900	CONFigure:BTS:NETWork[:TYPE] EGSM EGSM900
GSM 1800 (DCS 1800)	CONFigure:BTS:NETWork[:TYPE] DCS GSM1800
GSM 1900 (PCS 1900)	CONFigure:BTS:NETWork[:TYPE] PCS GSM1900
R-GSM 900	CONFigure:BTS:NETWork[:TYPE] RGSM RGSM900
PHASE I	CONFigure:BTS:NETWork:PHASE 1
PHASE II	CONFigure:BTS:NETWork:PHASE 2
PHASE II+	CONFigure:BTS:NETWork:PHASE 2,PLUS

PHASE/FREQ ERROR	CONFigure:BURSt:PFERror[:IMMediate]
SINGLE	INITiate<1 2>:CONTinuous OFF; INITiate<1 2>[:IMMediate]
CONTINUOUS	INITiate<1 2>:CONTinuous ON; INITiate<1 2>[:IMMediate]
NO. OF BURSTS	--
SET MANUAL	CONFigure:BURSt:PFERror:COUNT <numeric_value>
SET TO STANDARD	--
ARFCN / FREQUENCY	see sub menu SETTINGS
POWER SETTINGS	see sub menu SETTINGS
X UNIT SYMB TIME	CALCulate<1 2>:X:UNIT:TIME S SYM
TRIGGER	see sub menu SETTINGS
EDIT	--
PHASE PEAK	CONFigure:BTS:LIMit PPEak
PHASE RMS	CONFigure:BTS:LIMit PRMS
FREQUENCY	CONFigure:BTS:LIMit FREQuency
USER LIMIT ON OFF	CONFigure:BTS:LIMit:STANdard ON OFF
CARRIER POWER	CONFigure:BURSt:POWer[:IMMediate] CALCulate:LIMit:BURSt:POWer?
MEAS MAX OUTPUT PWR	READ:BURSt:POWer?
INC STATIC PWR CTRL	READ:BURSt:POWer:STATic?
INC DYNAM PWR CTRL	READ:BURSt:POWer:DYNamic?
NO. OF BURSTS	--
SET MANUAL	CONFigure:BURSt:POWer:COUNT <numeric_value>
SET TO STANDARD	--
SGL MEAS ON OFF	CONFigure:BTS:POWer:SINGle[:STATe] ON OFF
MEAS SGL PWR LEVEL	READ:BURSt:POWer?

STATIC PWR CTRL LEVEL	CONFigure:BTS:POWer:STAtic <numeric_value>
DYNAM PWR CTRL LEVEL	CONFigure:BTS:POWer:DYNAmic <numeric_value>
CLEAR SGL RESULT TAB	CONFigure:BTS:POWer:SINGle:CLEAr
SIGNAL POWER	CONFigure:BTS:POWer:EXPEcted <numeric_value>
ARFCN / FREQUENCY	see sub menu SETTINGS
POWER SETTINGS	see sub menu SETTINGS
CONDITIONS NORM EXTR	CONFigure:BURSt:POWer:CONDition NORMal EXTreme
MEAS BANDWIDTH	[SENSe<1 2>:]BANDwidth BWIDth[:RESolution] DEF 300 kHz 1 MHz
SYNC TO MIDAMBLE	TRIGger<1 2>[:SEquence]:SYNChronize:SOURce FRAME TSC
TRIGGER	see sub menu SETTINGS
POWER VS TIME	CONFigure:BURSt:PTEMplate[:IMMediate] CALCulate:LIMit:BURSt:PTEMplate?
SINGLE	INITiate<1 2>:CONTinuous OFF; INITiate[:IMMediate]
CONTINUOUS	INITiate<1 2>:CONTinuous ON; INITiate[:IMMediate]
BURST HIGH RESOLUTION	CONFigure:BURSt:PTEMplate:SElect TOP
NO. OF BURSTS	--
SET MANUAL	CONFigure:BURSt:PTEMplate:COUnT <numeric_value>
SET TO STANDARD	--
FULL BURST	CONFigure:BURSt:PTEMplate:SElect FULL
RISING EDGE	CONFigure:BURSt:PTEMplate:SElect RISing
FALLING EDGE	CONFigure:BURSt:PTEMplate:SElect FALLing
START REF MEAS	READ:BURSt:REFerence[:IMMediate]?
REF MEAS AUTO USER	CONFigure:BURSt:REFerence:AUTO ON OFF
ARFCN / FREQUENCY	see sub menu SETTINGS
POWER SETTINGS	see sub menu SETTINGS

X UNIT SYMB TIME	CALCulate<1 2>:X:UNIT:TIME S SYM
MEAS BANDWIDTH	[SENSe<1 2>:]BANDwidth BWIDth[:RESolution] DEF 300 kHz 1 MHz
SYNC TO MIDAMBLE	TRIGger<1 2>[:SEquence]:SYNChronize:SOURce FRAME TSC
TRIGGER	see sub menu SETTINGS
EDIT	--
LIMIT LINE FILTER	--
NEW LIMIT LINE	like basic instrument
EDIT LIMIT LINE	like basic instrument
COPY LIMIT LINE	like basic instrument
DELETE LIMIT LINE	like basic instrument
USER LIMIT ON OFF	CONFigure:BTS:LIMit:STANdard ON OFF
PAGE UP	--
PAGE DOWN	--
MODULATION SPECTRUM	CONFigure:SPECTrum:MODulation[:IMMediate] CALCulate:LIMit:SPECTrum:MODulation? ARFCn TXBand RXBand COMBined CALCulate:LIMit:SPECTrum:MODulation:FAILs? ARFCn TXBand RXBand COMBined CALCulate:LIMit:SPECTrum:MODulation:EXceptions? ARFCn TXBand RXBand COMBined
SINGLE FREQ SWEEP	INITiate<1 2>:CONTinuous OFF; INITiate[:IMMediate]
CONTINUOUS FREQ SWEEP	INITiate<1 2>:CONTinuous ON; INITiate[:IMMediate]
START LIST	READ:SPECTrum:MODulation[:ALL]?
NO. OF BURSTS	--
SET MANUAL	CONFigure:SPECTrum:MODulation:COUNT <numeric_value>
SET TO STANDARD	--
ARFCN ±1.8 MHZ	CONFigure:SPECTrum:MODulation:RANGE ARFCn
TX BAND	CONFigure:SPECTrum:MODulation:RANGE TXBand
±1.8 MHZ / TX BAND	CONFigure:SPECTrum:MODulation:RANGE COMBined

RX BAND	CONFigure:SPECTrum:MODulation:RANGe RXBand
ARFCN / FREQUENCY	see sub menu SETTINGS
POWER SETTINGS	see sub menu SETTINGS
RX BAND GAIN	[SENSe<1 2>:]CORRection:RXGain:INPut[:MAGNitude] <numeric_value>
TX GATE ON OFF	CONFigure:SPECTrum:MODulation:TGATe ON OFF
TRIGGER	see sub menu SETTINGS
EDIT	--
LIMIT LINE FILTER	--
NEW LIMIT LINE	like basic instrument
EDIT LIMIT LINE	like basic instrument
COPY LIMIT LINE	like basic instrument
DELETE LIMIT LINE	like basic instrument
USER LIMIT ON OFF	CONFigure:BTS:LIMit:STANdard ON OFF
PAGE UP	--
PAGE DOWN	--
TRANSIENT SPECTRUM	CONFigure:SPECTrum:SWITChing[:IMMediate] CALCulate:LIMit:SPECTrum:SWITChing? ARFCn TXBand RXBand COMBined CALCulate:LIMit:SPECTrum:SWITChing:FAILs? ARFCn TXBand RXBand COMBined
SINGLE FREQ SWEEP	INITiate<1 2>:CONTinuous OFF; INITiate[:IMMediate]
CONTINUOUS FREQ SWEEP	INITiate<1 2>:CONTinuous ON; INITiate[:IMMediate]
START LIST	READ:SPECTrum:SWITChing[:ALL]?
NO. OF BURSTS	--
SET MANUAL	CONFigure:SPECTrum:SWITChing:COUNT <numeric_value>
SET TO STANDARD	--
ARFCN / FREQUENCY	see sub menu SETTINGS
POWER SETTINGS	see sub menu SETTINGS

BTS SFH ON OFF	CONFigure:BTS:CHANnel:SFH ON OFF		
MEAS BANDWIDTH	[SENSe<1 2>:]BANDwidth BWIDth[:RESolution] DEF 300 kHz 1 MHz		
TRIGGER	see sub menu SETTINGS		
EDIT	--		
LIMIT LINE FILTER	--		
NEW LIMIT LINE	like basic instrument		
EDIT LIMIT LINE	like basic instrument		
COPY LIMIT LINE	like basic instrument		
DELETE LIMIT LINE	like basic instrument		
USER LIMIT ON OFF	CONFigure:BTS:LIMit:STANdard ON OFF		
PAGE UP	--		
PAGE DOWN	--		
SPURIOUS	CONFigure:SPURious[:IMMediate] CALCulate:LIMit:SPURious? CALCulate:LIMit:SPURious:FAILs?	TXBand OTXBand RXBand TXBand OTXBand RXBand	
START LIST SGL STEP	ABORT;READ:SPUR:STEP?		
CONT LIST SGL STEP	READ:SPUR:STEP?		
START LIST	READ:SPUR[:ALL]?		
SWEEP COUNT	--		
SWP COUNT TX / <> TX	CONFigure:SPURious:COUNT <numeric_value>		
SWP COUNT RX BAND	CONFigure:SPURious:COUNT:RXBand <numeric_value>		
SET TO STANDARD	--		
TX BAND	CONFigure:SPURious:RANGe	TXBand	
<> TX BAND	CONFigure:SPURious:RANGe	OTXBand	
RX BAND	CONFigure:SPURious:RANGe	RXBand	

TX BAND ±2.MHZ	CONFigure:SPURious:RANGE COMBined
SELECT STEP	CONFigure:SPURious:STEP:COUNT? CONFigure:SPURious:STEP<1..26> ON OFF
ARFCN / FREQUENCY	see sub menu SETTINGS
POWER SETTINGS	see sub menu SETTINGS
BTS SFH ON OFF	CONFigure:BTS:CHANnel:SFH ON OFF
TX SUPPR ON OFF	CONFigure:BTS:TXSupp ON OFF
RX BAND GAIN	[SENSe<1 2>:]CORRection:RXGain:INPut[:MAGNitude] <numeric_value>
COSITING	CONFigure:BTS:COsiting ON OFF
SWEEPTIME STD AUTO	CONFigure:BTS:SWEEptime STANDard AUTO
TRIGGER	see sub menu SETTINGS
EDIT	--
LIMIT LINE FILTER	--
NEW LIMIT LINE	like basic instrument
EDIT LIMIT LINE	like basic instrument
COPY LIMIT LINE	like basic instrument
DELETE LIMIT LINE	like basic instrument
USER LIMIT ON OFF	CONFigure:BTS:LIMit:STANDard ON OFF
PAGE UP	--
PAGE DOWN	--

4.2.2 GSM MS Analysis Mode (Option FSE-K10)

4.2.2.1 CONFIGURATION Key Group

MODE	
GSM MS ANALYZER	INSTRument<1 2>[:SElect] MGSM
SETTINGS	--
EXTERNAL ATTEN	[SENSe<1 2>:]CORRection:LOSS:INPut[:MAGNitude] <numeric_value>
ARFCN / FREQUENCY	--
ARFCN	CONFigure:MS:ARFCn <numeric_value>
ARFCN AUTOSELECT	CONFigure:MS:ARFCn:AUTO ONCE
FREQUENCY	SENSe<1 2>:FREQuency:CENTer <numeric_value>
POWER SETTINGS	--
EXTERNAL ATTEN	[SENSe<1 2>:]CORRection:LOSS:INPut[:MAGNitude] <numeric_value>
OUTPUT MS POWER	CONFigure:MS:POWer:EXPEcted <numeric_value>
POWER CLASS	CONFigure:MS:POWer:CLASs <numeric_value>
POWER CTRL LEVEL	CONFigure:MS:POWer:LEVel <numeric_value>
SMALL MS ON OFF	CONFigure:MS:POWer:SMALL ON OFF
LIMIT/PWR COUPLED	CONFigure:MS:POWer:COUPled ON OFF
SIGNAL POWER	CONFigure:MS:POWer:EXPEcted <numeric_value>
LIMIT LINE REF POWER	CONFigure:MS:POWer:LIMit <numeric_value>
LIMIT MARGIN	CALCulate<1 2>:LIMit:MARGin <numeric_value>
MIDAMBLE	CONFigure:MS:CHANnel:TSC 0...7
TRIGGER	--

FREE RUN	TRIGger<1 2>[:SEQuence]:SOURce	IMMediate
VIDEO	TRIGger<1 2>[:SEQuence]:SOURce	VIDeo
EXTERN	TRIGger<1 2>[:SEQuence]:SOURce TRIGger<1 2>[:SEQuence]:LEVel[:EXTErnal] -5.0...+5.0V	EXTErnal
RF POWER	TRIGger<1 2>[:SEQuence]:SOURce	RFPower
SLOPE POS NEG	TRIGger<1 2>[:SEQuence]:SLOPe	POSitive NEGative
TRIGGER ADJUST	--	
COURSE ADJUST	TRIGger<1 2>[:SEQuence]:SYNChronize:ADJust:SLOT <numeric_value>	
FINE ADJUST	TRIGger<1 2>[:SEQuence]:SYNChronize:ADJust:SLOT <numeric_value>	
AUTO ADJUST	TRIGger<1 2>[:SEQuence]:SYNChronize:ADJust:SLOT:AUTO	ONCE
TRIGGER LEVEL	TRIGger<1 2>[:SEQuence]:LEVel[:EXTErnal] <numeric_value>	
SLOPE POS NEG	TRIGger<1 2>[:SEQuence]:SLOPe	POSitive NEGative
DEFAULT SETTINGS	CONFIgure:MS:PRESet	
P-GSM 900	CONFIgure:MS:NETWork[:TYPE]	PGSM PGSM900
E-GSM 900	CONFIgure:MS:NETWork[:TYPE]	EGSM EGSM900
GSM 1800 (DCS 1800)	CONFIgure:MS:NETWork[:TYPE]	DCS GSM1800
GSM 1900 (PCS 1900)	CONFIgure:MS:NETWork[:TYPE]	PCS GSM1900
R-GSM 900	CONFIgure:MS:NETWork[:TYPE]	RGSM RGSM900
PHASE I	CONFIgure:MS:NETWork:PHASE	1
PHASE II	CONFIgure:MS:NETWork:PHASE	2
PHASE II+	CONFIgure:MS:NETWork:PHASE	2, PLUS

PHASE/FREQ ERROR	CONFigure:BURSt:PFERror[:IMMediate]
SINGLE	INITiate<1 2>:CONTInuous OFF; INITiate<1 2>[:IMMediate]
CONTINUOUS	INITiate<1 2>:CONTInuous ON; INITiate<1 2>[:IMMediate]
NO. OF BURSTS	
SET MANUAL	CONFigure:BURSt:PFERror:COUNT <numeric_value>
SET TO STANDARD	--
ARFCN / FREQUENCY	see sub menu SETTINGS
POWER SETTINGS	see sub menu SETTINGS
X UNIT SYMB TIME	CALCulate<1 2>:X:UNIT:TIME S SYM
TRIGGER	see sub menu SETTINGS
EDIT	--
PHASE PEAK	CONFigure:MS:LIMit:PPEak
PHASE RMS	CONFigure:MS:LIMit:PRMS
FREQUENCY	CONFigure:MS:LIMit:FREQuency
USER LIMIT ON OFF	CONFigure:MS:LIMit:STANDARD ON OFF
CARRIER POWER	CONFigure:BURSt:POWER[:IMMediate] CALCulate:LIMit:BURSt:POWER?
MEAS MAX OUTPUT PWR	READ:BURSt:POWER?
INC PWR CTRL LEVEL	READ:BURSt:POWER:LEVel?
NO. OF BURSTS	--
SET MANUAL	CONFigure:BURSt:POWER:COUNT <numeric_value>
SET TO STANDARD	--
SGL MEAS ON OFF	CONFigure:MS:POWER:SINGLE[:STATe] ON OFF

MEAS SGL PWR LEVEL	READ: BURSt: PWeR?
POWER CTRL LEVEL	CONFigure: MS: PWeR: LEVel <numeric_value>
CLEAR SGL RESULT TAB	CONFigure: MS: PWeR: SINGle: CLear
SIGNAL POWER	CONFigure: MS: PWeR: EXPeCted <numeric_value>
ARFCN / FREQUENCY	see sub menu SETTINGS
POWER SETTINGS	see sub menu SETTINGS
CONDITIONS NORM EXTR	CONFigure: BURSt: PWeR: CONDition NORMal EXTReMe
MEAS BANDWIDTH	[SENSe<1 2>:]BANDwidth BWIDth[:RESolution] DEF 300 kHz 1 MHz
SYNC TO MIDAMBLE	TRIGger<1 2>[:SEquence]:SYNChronize:SOURce FRAME TSC
TRIGGER	see sub menu SETTINGS
POWER VS TIME	CONFigure: BURSt: PTEMplate[:IMMediate] CALCulate: LIMit: BURSt: PTEMplate?
SINGLE	INITiate<1 2>:CONTinuous OFF; INITiate<1 2>[:IMMediate]
CONTINUOUS	INITiate<1 2>:CONTinuous ON; INITiate<1 2>[:IMMediate]
BURST HIGH RESOLUTION	CONFigure: BURSt: PTEMplate: SElect TOP
NO. OF BURSTS	--
SET MANUAL	CONFigure: BURSt: PTEMplate: COUNT <numeric_value>
SET TO STANDARD	--
FULL BURST	CONFigure: BURSt: PTEMplate: SElect FULL
RISING EDGE	CONFigure: BURSt: PTEMplate: SElect RISing
FALLING EDGE	CONFigure: BURSt: PTEMplate: SElect FALLing
START REF MEAS	READ: BURSt: REFerence[:IMMediate]?
REF MEAS AUTO USER	CONFigure: BURSt: REFerence: AUTO ON OFF

ARFCN / FREQUENCY	see sub menu SETTINGS
POWER SETTINGS	see sub menu SETTINGS
X UNIT SYMB TIME	CALCulate<1 2>:X:UNIT:TIME S SYM
MEAS BANDWIDTH	[SENSe<1 2>:]BANDwidth BWIDth[:RESolution] DEF 300 kHz 1 MHz
SYNC TO MIDAMBLE	TRIGger<1 2>[:SEquence]:SYNChronize:SOURce FRAME TSC
TRIGGER	see sub menu SETTINGS
EDIT	--
LIMIT LINE FILTER	--
EDIT LIMIT LINE	like basic instrument
USER LIMIT ON OFF	CONFigure:MS:LIMIt:STANDARD ON OFF
PAGE UP	--
PAGE DOWN	--
MODULATION SPECTRUM	CONFigure:SPECTrum:MODulation[:IMMediate] CALCulate<1 2>:LIMIt:SPECTrum:MODulation? ARFCn TXBand RXBand COMBined DCSRx1800 CALCulate<1 2>:LIMIt:SPECTrum:MODulation:FAILs? ARFCn TXBand RXBand COMBined DCSRx1800 CALCulate<1 2>:LIMIt:SPECTrum:MODulation:EXCeptions? ARFCn TXBand RXBand COMBined DCSRx1800 INITiate<1 2>:CONTinuous OFF; INITiate[:IMMediate]
SINGLE FREQ SWEEP	INITiate<1 2>:CONTinuous ON; INITiate[:IMMediate]
CONTINUOUS FREQ SWEEP	INITiate<1 2>:CONTinuous ON; INITiate[:IMMediate]
START LIST	READ:SPECTrum:MODulation[:ALL]?
NO. OF BURSTS	--
SET MANUAL	CONFigure:SPECTrum:MODulation:COUNT <numeric_value>
SET TO STANDARD	--
ARFCN ± 1.8 MHz	CONFigure:SPECTrum:MODulation:RANGE ARFCn
TX BAND	CONFigure:SPECTrum:MODulation:RANGE TXBand

±1.8 MHZ TX BAND	CONFigure:SPECTrum:MODulation:RANGE COMBined
RX BAND GSM 900	CONFigure:SPECTrum:MODulation:RANGE RXBand
RX BAND DCS 1800	CONFigure:SPECTrum:MODulation:RANGE DCSRx1800
ARFCN / FREQUENCY	see sub menu SETTINGS
POWER SETTINGS	see sub menu SETTINGS
RX BAND GAIN	[SENSe<1 2>:]CORRection:RXGain:INPut[:MAGNitude] <numeric_value>
TRIGGER	see sub menu SETTINGS
EDIT	--
LIMIT LINE FILTER	--
EDIT LIMIT LINE	like basic instrument
USER LIMIT ON OFF	CONFigure:MS:LIMit:STANDard ON OFF
PAGE UP	--
PAGE DOWN	--
TRANSIENT SPECTRUM	CONFigure:SPECTrum:SWITChing[:IMMediate] CALCulate<1 2>:LIMit:SPECTrum:SWITChing? ARFCn TXBand RXBand COMBined CALCulate<1 2>:LIMit:SPECTrum:SWITChing:FAILs? ARFCn TXBand RXBand COMBined
SINGLE FREQ SWEEP	INITiate<1 2>:CONTInuous OFF; INITiate<1 2>[:IMMediate]
CONTINUOUS FREQ SWEEP	INITiate<1 2>:CONTInuous ON; INITiate<1 2>[:IMMediate]
START LIST	READ:SPECTrum:SWITChing[:ALL]?
NO. OF BURSTS	--
SET MANUAL	CONFigure:SPECTrum:SWITChing:COUNt <numeric_value>
SET TO STANDARD	--
ARFCN / FREQUENCY	see sub menu SETTINGS

POWER SETTINGS	see sub menu SETTINGS		
MS SFH ON OFF	CONFigure:MS:CHANnel:SFH ON OFF		
MEAS BANDWIDTH	[SENSe<1 2>:]BANdwidth BWIth[:RESolution] DEF 300 kHz 1 MHz		
TRIGGER	see sub menu SETTINGS		
EDIT	--		
LIMIT LINE FILTER	--		
EDIT LIMIT LINE	like basic instrument		
USER LIMIT ON OFF	CONFigure:MS:LIMit:STANdard ON OFF		
PAGE UP	--		
PAGE DOWN	--		
SPURIOUS	CONFigure:SPURious[:IMMediate] CALCulate:LIMit:SPURious? CALCulate:LIMit:SPURious:FAILs?	TXBand OTXBand IDLeband TXBand OTXBand IDLeband	
START LIST SGL STEP	ABORT;READ:SPUR:STEP?		
CONT LIST SGL STEP	READ:SPUR:STEP?		
START LIST	READ:SPUR[:ALL]?		
SWEEP COUNT	--		
SWP COUNT TX / <>TX	CONFigure:SPURious:COUNT <numeric_value>		
TX BAND	CONFigure:SPURious:RANGe	TXBand	
<> TX BAND	CONFigure:SPURious:RANGe	OTXBand	
IDLE MODE	CONFigure:SPURious:RANGe	IDLeband	
TX BAND ±2.0 MHZ	CONFigure:SPURious:RANGe	IDLeband	
SELECT STEP	CONFigure:SPURious:STEP:COUNT? CONFigure:SPURious:STEP<1..26> ON OFF		
ARFCN / FREQUENCY	see sub menu SETTINGS		

POWER SETTINGS	see sub menu SETTINGS
MS SFH ON OFF	CONFigure:MS:CHANnel:SFH ON OFF
TX SUPPR ON OFF	CONFigure:MS:TXSupp ON OFF
ANTENNA COND RAD	CONFigure:SPURious:ANTenna CONDUCTed RADIated
SWEEPTIME STD AUTO	CONFigure:MS:SWEeptime STANDARD AUTO
TRIGGER	see sub menu SETTINGS
EDIT	--
LIMIT LINE FILTER	--
EDIT LIMIT LINE	like basic instrument
USER LIMIT ON OFF	CONFigure:MS:LIMit:STANDard ON OFF
PAGE UP	--
PAGE DOWN	--